

RoHS 2.0

REV.	BCN NO.	DESCRIPTION	DATE	DESIGN
A1.	/.	重新核对图面	21.01.14	LiHui

PIN NUMBER	SIGNAL NAME
PIN 1	Vbus
PIN 2	D-
PIN 3	D+
PIN 4	GND
PIN 5	Std_SSRX-
PIN 6	Std_SSRX+
PIN 7	GND_DRAIN
PIN 8	Std_SSTX-
PIN 9	Std_SSTX+
SHELL	GND

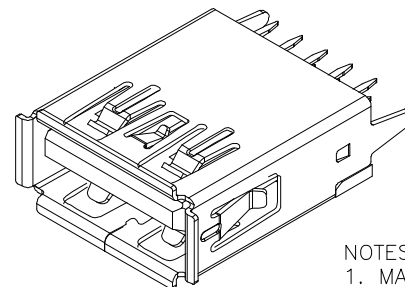

3D VIEW

NOTES:

- MATERIAL:
 - HOUSING: LCP ,COLOR IS BLUE;
 - CONTACT: BRASS (H65 T=0.20&0.25mm);
 - SHELL: COLD ROLLED IRON (SPCC T=0.30mm);
- ELECTRICAL:
 - VOLTAGE RATING: 30V DC ;
 - CURRENT RATING: 1.5A ;
 - CONTACT RESISTANCE: 30MILLIOHMS MAX.;
 - WITHSTAND VOLTAGE: 100V AC RMS 50(60)Hz,1MIN.;
 - INSULATION RESISTANCE: 100MEGOHMS MIN @500V DC;
- MECHANICAL:
 - MATING FORCE: 35N MAX.;
 - UNMATING FORCE: 5~35N ;
 - OPERATING LIFE: 1500 CYCLES MIN.;
- PLATING:
 - TERMINAL:
 - NI PLATING OVER ALL,
 - Tin PLATING ON SOLDER AREA,
 - Au G/Fu" ON CONTACT AREA;
 - SHELL: NI PLATING OVER ALL;
- ENVIRONMENTAL:
 - STORAGE TEMPERATURE RANGE: -40°C~+85°C;
 - OPERATION TEMPERATURE RANGE: -25°C~+70°C;

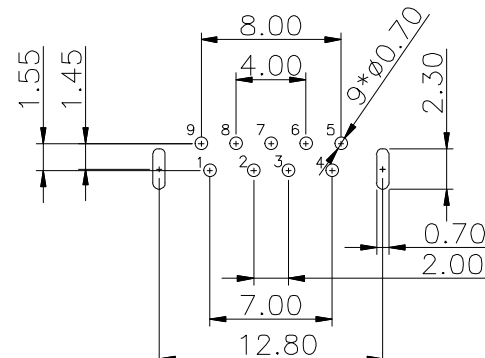
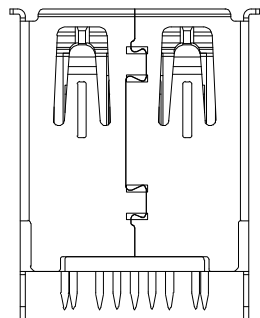
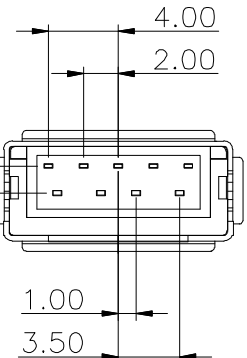
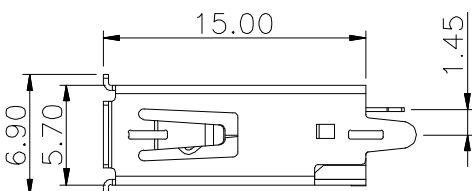
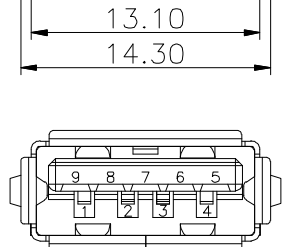
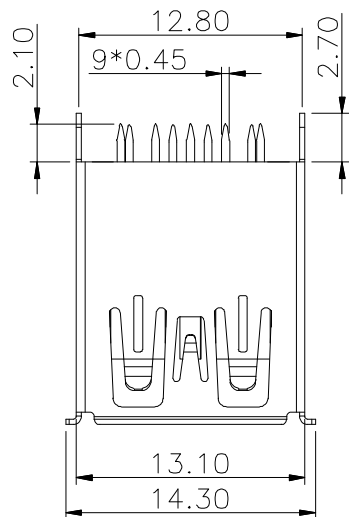

RECOMMENDER P.C.B.LAYOUT TOP VIEW
(COMPONENT SIDE TOLERANCE±0.05)

富港电子

UNLESS OTHERWISE SPECIFIED: GENERAL TOLERANCE: X.xxx ±0.10 X.xx ±0.20 X.x ±0.30		NAME: 3.0 A母180° L15.0卷边直脚		P/N: ST-003-010-L15.0-J	
THIRD ANGLE PROJECTION 		UNIT: MM	SCALE: 1:1	SIZE: A4	SHEET: 1/1
DRAWN:		CHECKED:		APPROVED:	
ANGULAR: X.xx° ±1° X.x° ±3° X° ±5°					