

MCQ1V3216

Multilayer high Q chip inductor

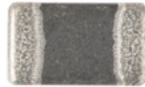

Product features

- 1206 (3216 metric) package
- Multilayer monolithic construction yields high reliability
- Inductance range from 0.047 μ H to 4.7 μ H
- Moisture sensitivity level (MSL): 1

Applications

- Industrial connectivity (IoT)
- Wireless communications
- Bluetooth
- WiFi
- Antenna
- Machine-to-machine (M2M)
- Mobile phones
- Wearable devices
- Wireless LAN
- Computing/gaming consoles
- Broadband components
- RF transceiver modules

Environmental compliance and general specifications

- Operating temperature range: -40 °C to +85 °C (ambient plus self-temperature rise)



Product specifications

Part number ⁴	Ls Tolerance (%)	Ls ¹ (μH)	Q minimum	DCR (Ω) @ +25 °C maximum	Test frequency ² (MHz)	Test voltage ² (mV)	SRF (MHz) minimum	Rated I ³ maximum (mA)
MCQ1V3216-R047-R	±10	0.047	30	0.15	50	50	320	300
MCQ1V3216-R056-R	±10	0.056	30	0.2	50	50	320	300
MCQ1V3216-R068-R	±10	0.068	30	0.25	50	50	280	300
MCQ1V3216-R082-R	±10	0.082	30	0.25	50	50	280	300
MCQ1V3216-R100-R	±10	0.10	25	0.25	25	50	235	250
MCQ1V3216-R120-R	±10	0.12	25	0.25	25	50	220	250
MCQ1V3216-R150-R	±10	0.15	25	0.25	25	50	200	250
MCQ1V3216-R180-R	±10	0.18	25	0.3	25	50	185	250
MCQ1V3216-R220-R	±10	0.22	25	0.3	25	50	170	250
MCQ1V3216-R270-R	±10	0.27	25	0.3	25	50	150	250
MCQ1V3216-R330-R	±10	0.33	25	0.3	25	50	145	250
MCQ1V3216-R390-R	±10	0.39	30	0.5	25	50	135	200
MCQ1V3216-R470-R	±10	0.47	30	0.5	25	50	125	200
MCQ1V3216-R560-R	±10	0.56	30	0.5	25	50	115	150
MCQ1V3216-R680-R	±10	0.68	30	0.5	25	50	105	150
MCQ1V3216-R820-R	±10	0.82	30	0.6	25	50	100	150
MCQ1V3216-1R0-R	±10	1.0	35	0.3	10	50	75	100
MCQ1V3216-1R2-R	±10	1.2	35	0.4	10	50	65	100
MCQ1V3216-1R5-R	±10	1.5	35	0.4	10	50	60	50
MCQ1V3216-1R8-R	±10	1.8	35	0.4	10	50	55	50
MCQ1V3216-2R2-R	±10	2.2	35	0.5	10	50	50	50
MCQ1V3216-2R7-R	±10	2.7	35	0.5	10	50	45	50
MCQ1V3216-3R3-R	±10	3.3	35	0.5	10	50	41	50
MCQ1V3216-3R9-R	±10	3.9	35	0.6	10	50	38	50
MCQ1V3216-4R7-R	±10	4.7	35	0.65	10	50	35	25

1. Ls = Inductance

2. Ls and Q test voltage and frequency

3. Rated I: Current rating for an approximate self-temperature rise of 40 °C or less.

4. Part Number Definition: MCQ1V3216-xxx-R

MCQ1V3216 = Product code and size

xxx= inductance value in μH, R= decimal point,

If no R is present then last character equals number of zeros

-R suffix = RoHS compliant

Mechanical parameters, schematic, pad layout (mm)

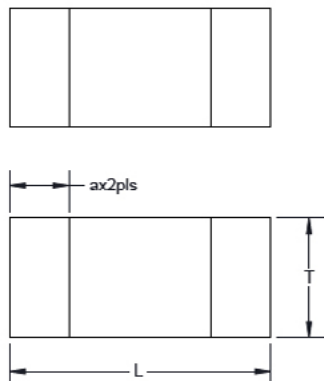

Recommended pad layout

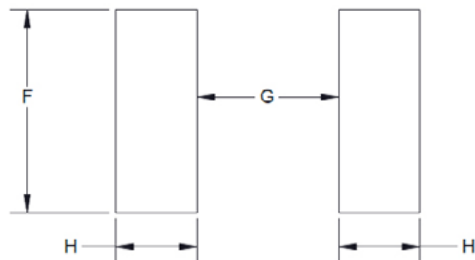

Schematic

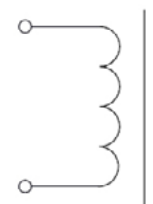

Part Number	L	W	T	a	F	G	H
MCQ1V3216-xxx-R	3.20 ±0.20	1.60 ±0.20	0.90 ±0.20	0.50 ±0.30	2.00 ref	1.40 ref	1.20 ref

Part marking: No marking
 All soldering surfaces to be coplanar within 0.1 millimeters
 Tolerances are ±0.1 millimeters unless stated otherwise
 Pad layout dimensions are reference only
 Traces or vias underneath the inductor is not recommended

Packaging information (mm)

Drawing not to scale
 Supplied in tape and reel packaging, 4000 parts per 7" diameter reel

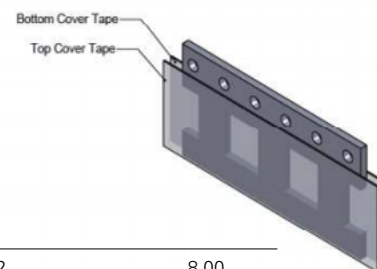
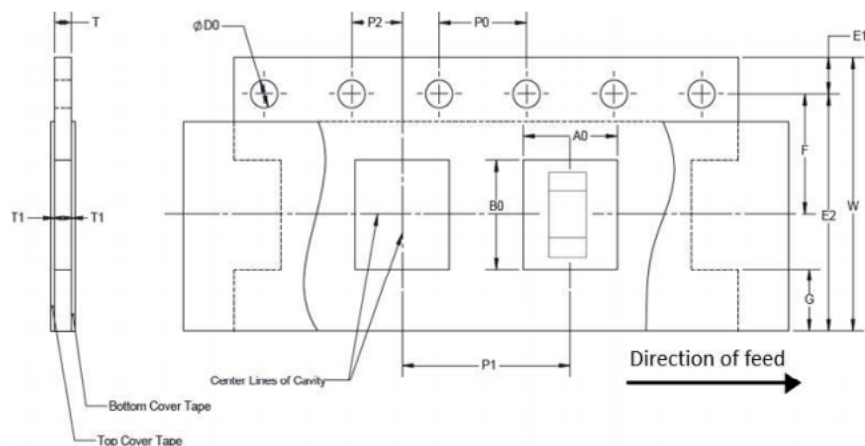

W±0.2	8.00
F±0.1	3.50
E1±0.2	1.75
E2 Min	na
P0±0.2	4.00
P1±0.2	4.00
P2±0.1	2.00
D0±0.1	1.55
A0	1.9±0.2
B0	3.5±0.2
T	0.95±0.1
T1 Max	na

Qualification testing

No.	Test item	Sample size (pcs)	Test condition	Acceptable value/range
1	External visual	72		No physical damage
2	Physical dimension	72	Specification	Specification
3	Initial electrical test	72	Specification	User spec
4	Solderability	6	+245 °C ±5 °C, dipping 5 ±1 s	>95% solder coverage
5	Resistance to soldering heat	6	+260 ±5 °C for 10±1 s	1. $\Delta L/L < \pm 20\%$ 2. $\Delta Q/Q < \pm 30\%$ 3. No physical damage
6	Terminal strength (SMD)	6	Force of 10N for 10 ±1 s	No physical damage No electrical performance test
7	Low temperature exposure	6	-40 °C for 1000 hours	1. $\Delta L/L < \pm 10\%$ 2. $\Delta Q/Q < \pm 30\%$ 3. No physical damage
8	Bending strength	6	Appendix 2 note: 2 mm, hold time 30 s (minimum)	No physical damage No electrical performance test
9	Drop	6	Drop 10 times to a concrete floor from a height of 1 m	1. $\Delta L/L < \pm 10\%$ 2. $\Delta Q/Q < \pm 30\%$ 3. No physical damage
10	Vibration	6	Amplitude modulation: 1.5 mm Test time: A period of 2 hours in each of 3 mutually perpendicular directions Test from 10 Hz to 55 Hz to 10 Hz for 1 minute	1. $\Delta L/L < \pm 10\%$ 2. $\Delta Q/Q < \pm 30\%$ 3. No physical damage
11	High temperature exposure	6	+85 °C for 1000 hours	1. $\Delta L/L < \pm 10\%$ 2. $\Delta Q/Q < \pm 30\%$ 3. No physical damage
12	Biased humidity	6	1000 hours +60 °C/90% to 95%RH unpowered	1. $\Delta L/L < \pm 10\%$ 2. $\Delta Q/Q < \pm 30\%$ 3. No physical damage
13	Operational life	12	+85 °C at Rated current for 1000 hours	1. $\Delta L/L < \pm 10\%$ 2. $\Delta Q/Q < \pm 30\%$ 3. No physical damage
14	Temperature cycling	6	32 cycles (-40 °C to +85 °C), dwell time 30 minutes	1. $\Delta L/L < \pm 10\%$ 2. $\Delta Q/Q < \pm 30\%$ 3. No physical damage

Ls (Inductance) vs frequency

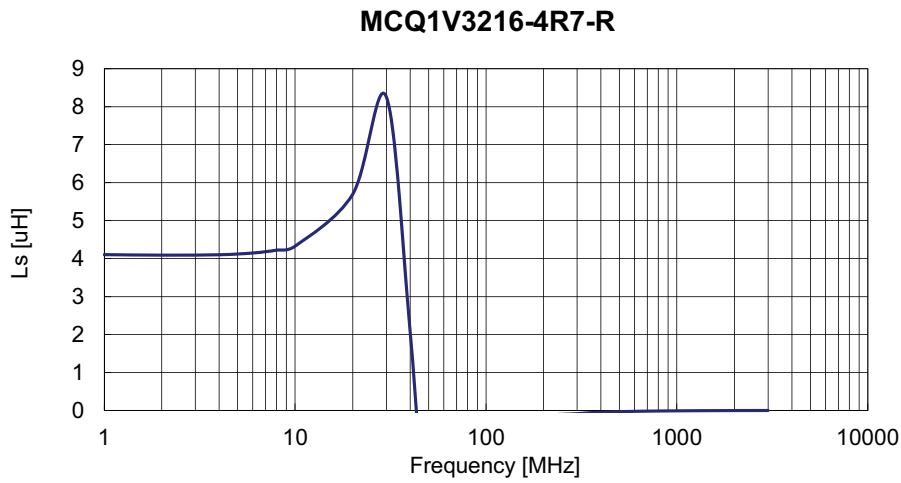
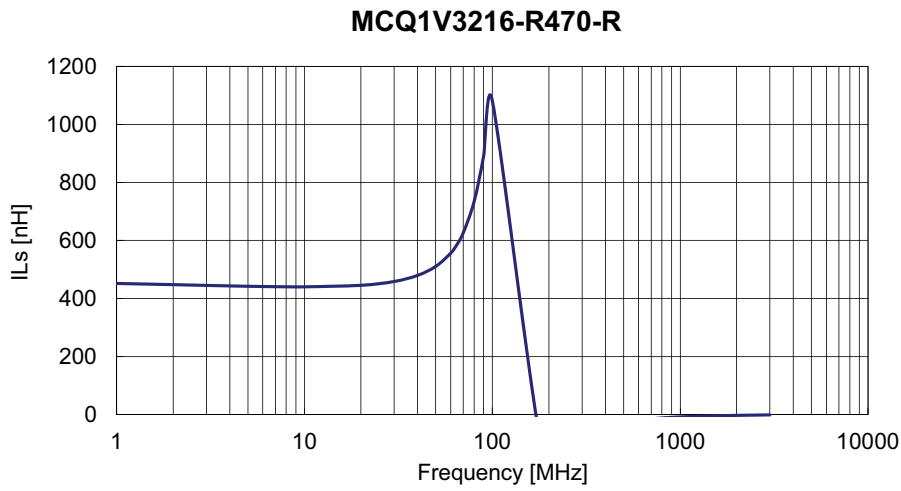
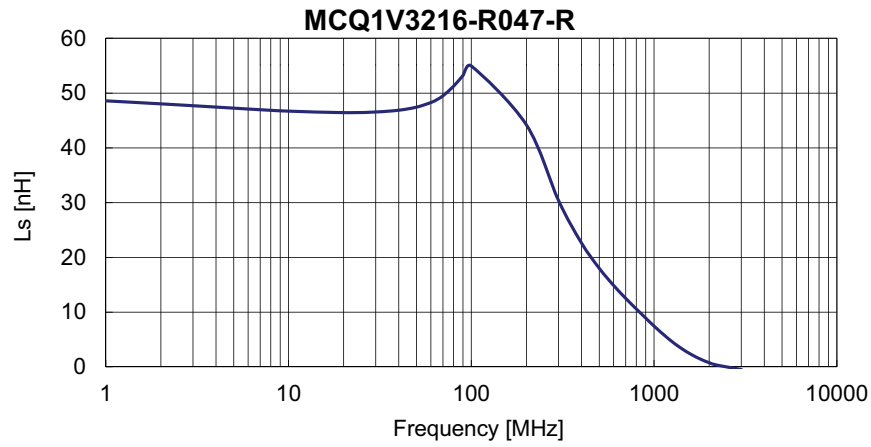

Q vs frequency

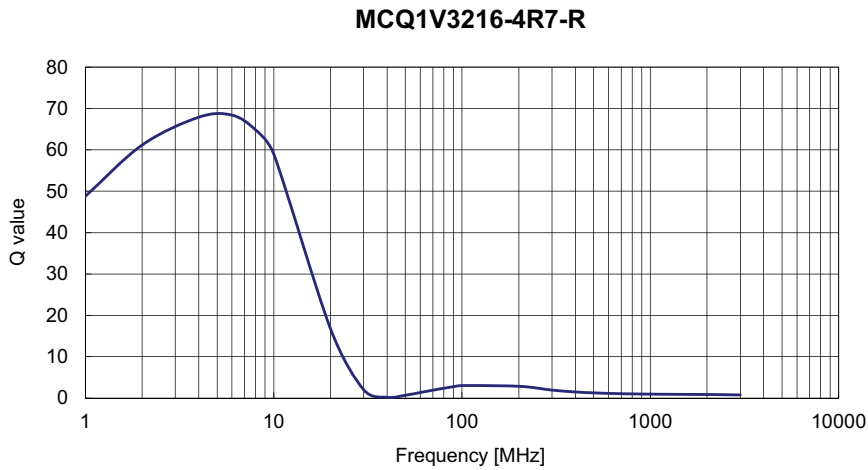
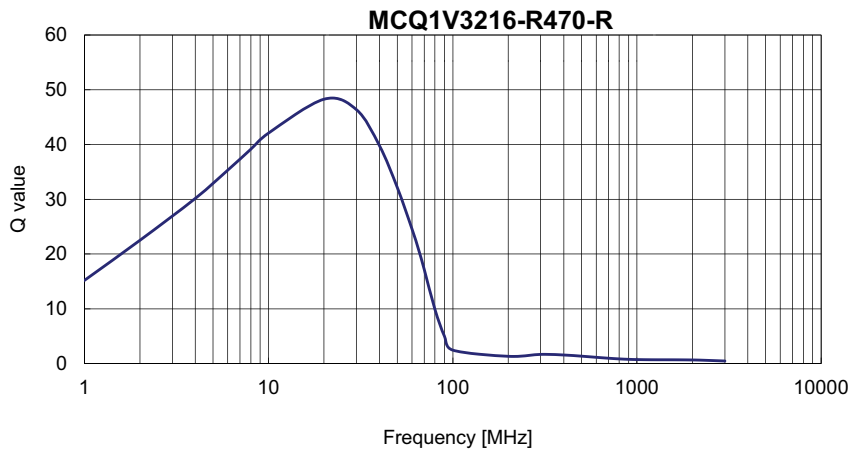
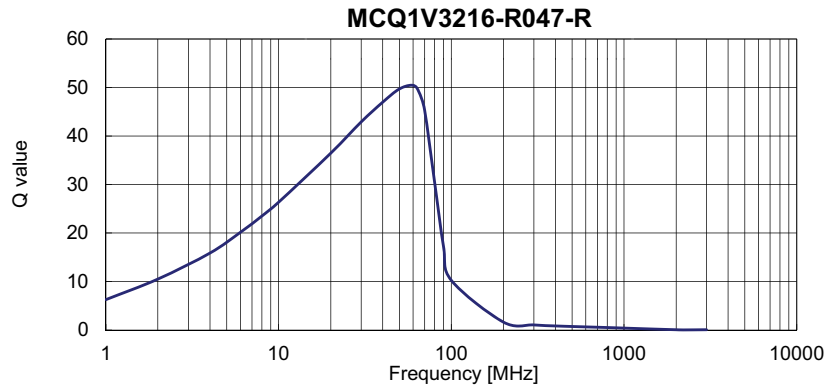

Solder reflow profile

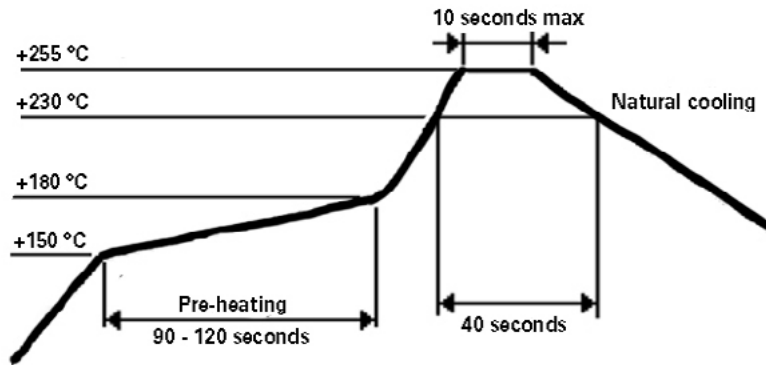

Life Support Policy: Eaton does not authorize the use of any of its products for use in life support devices or systems without the express written approval of an officer of the Company. Life support systems are devices which support or sustain life, and whose failure to perform, when properly used in accordance with instructions for use provided in the labeling, can be reasonably expected to result in significant injury to the user.

Eaton reserves the right, without notice, to change design or construction of any products and to discontinue or limit distribution of any products. Eaton also reserves the right to change or update, without notice, any technical information contained in this bulletin.

Eaton
Electronics Division
1000 Eaton Boulevard
Cleveland, OH 44122
United States
Eaton.com/electronics

© 2020 Eaton
All Rights Reserved
Printed in USA
Publication No. 11102 BU-MC20081
June 2020

Eaton is a registered trademark.

All other trademarks are property of their respective owners.

Follow us on social media to get the latest product and support information.

