

Model 356C

Advanced PLL HCMOS VCXO

Features

- Ceramic Surface Mount Package
- Low Phase Jitter Performance, 600fs Typical
- Advanced PLL Design w/ Low Fundamental Crystal
- Frequency Range 10 – 250MHz *
- +2.5V or +3.3V Operation
- Output Enable Standard
- Tape and Reel Packaging, EIA-418

Applications

- Broadcast Video Systems
- Storage Area Networking
- Broadband Access
- Phase-Locked Loop
- Networking Equipment
- Ethernet/GbE/SyncE
- Fiber Channel
- Test and Measurement

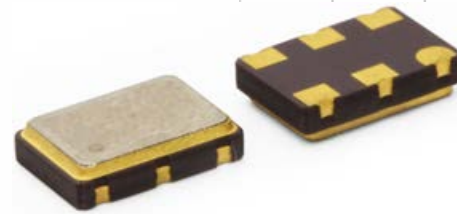

Part Dimensions:
7.0 × 5.0 × 1.85mm • 174.2mg

Standard Frequencies

- 25.00MHz	- 100.00MHz	- 155.52MHz
- 50.00MHz	- 122.88MHz	- 156.25MHz
- 74.25MHz	- 125.00MHz	- 200.00MHz
- 77.76MHz	- 148.50MHz	- 250.00MHz

* See Page 7 for additional developed frequencies.
Check with factory for availability of frequencies not listed.

Description

CTS Model 356C is a low cost, high performance PLL voltage controlled oscillator supporting HCMOS output. Employing the latest IC technology, M356C has excellent stability and low phase jitter performance.

Ordering Information

Model	Output Type	Frequency Code [MHz]	Absolute Pull Range	Frequency Stability	Temperature Range	Supply Voltage	Packaging
356	C	XXX or XXXX	B	3	I	3	T
	Code Output C HCMOS		Code APR B ±50ppm		Code Temp. Range C -20°C to +70°C I -40°C to +85°C		Code Packing T 1k pcs./reel
		Code Frequency Product Frequency Code ¹		Code Stability 5 ±25ppm ² 4 ±30ppm 3 ±50ppm		Code Voltage 2 +2.5Vdc 3 +3.3Vdc	

Notes:

- 1] Refer to document 016-1454-0, Frequency Code Tables.
3-digits for frequencies <100MHz, 4-digits for frequencies 100MHz or greater.
- 2] Check factory availability when paired with "I" temperature code.

**Not all performance combinations and frequencies may be available.
Contact your local CTS Representative or CTS Customer Service for availability.**

This product is specified for use only in standard commercial applications. Supplier disclaims all express and implied warranties and liability in connection with any use of this product in any non-commercial applications or in any application that may expose the product to conditions that are outside of the tolerances provided in its specification.



Electrical Specifications

Operating Conditions

PARAMETER	SYMBOL	CONDITIONS	MIN	TYP	MAX	UNIT
Maximum Supply Voltage	V_{CC}	-	-0.5	-	4.0	V
Maximum Control Voltage	V_C	$V_{CC} = +2.5V$	-0.5	-	3.0	V
		$V_{CC} = +3.3V$	-0.5	-	3.8	V
Supply Voltage	V_{CC}	$\pm 5\%$	2.375	2.5	2.625	V
			3.135	3.3	3.465	
Supply Current	I_{CC}	Maximum Load	-	20	65	mA
Operating Temperature	T_A	-	-20	+25	+70	°C
			-40	-	+85	
Storage Temperature	T_{STG}	-	-55	-	+125	°C

Frequency Stability

PARAMETER	SYMBOL	CONDITIONS	MIN	TYP	MAX	UNIT
Frequency Range	f_O	-		10 - 250		MHz
Frequency Stability [Note 1]	$\Delta f/f_O$	-		25, 30 or 50		\pm ppm
Absolute Pull Range [Note 2]	APR	-	50	-	-	\pm ppm
Aging	$\Delta f/f_{25}$	First Year @ +25°C, nominal V_{CC}	-3	-	3	ppm

1.] Inclusive of initial tolerance at time of shipment, changes in supply voltage, load, temperature and 1st year aging.

2.] Minimum guaranteed frequency shift from f_O over variations in temperature, aging, power supply and load.

Output Parameters

PARAMETER	SYMBOL	CONDITIONS	MIN	TYP	MAX	UNIT
Output Type	-	-		HCMOS		-
Output Load	C_L	-	-	-	15	pF
Output Voltage Levels	V_{OH}	CMOS Load	$0.9V_{CC}$	-	-	V
	V_{OL}		-	-	$0.1V_{CC}$	
Output Duty Cycle	SYM	@ 50% Level	45	-	55	%
Rise and Fall Time	T_R, T_F	@ 20%/80% Levels, $C_L = 15pF$	-	5	10	ns
Start Up Time	T_S	Application of V_{CC}	-	3	5	ms
Enable Function [Tri-State]						
Enable Input Voltage	V_{IH}	Pin 2 Logic '1', Output Enabled	$0.7V_{CC}$	-	-	V
Disable Input Voltage	V_{IL}	Pin 2 Logic '0', Output Disabled	-	-	$0.3V_{CC}$	V
Disable Current	I_{IL}	Pin 2 Logic '0', Output Disabled	-	16	22	mA
Enable Time	T_{PLZ}	Pin 2 Logic '1', Output Enabled	-	-	200	ns
Phase Jitter, RMS	t_{jrms}	Bandwidth 12 kHz - 20 MHz	-	600	<1000	fs
Period Jitter, RMS	p_{jrms}	-	-	3.0	-	ps
Period Jitter, pk-pk	p_{jpk-pk}	-	-	30	-	ps

Electrical Specifications

Control Voltage

PARAMETER	SYMBOL	CONDITIONS	MIN	TYP	MAX	UNIT
Control Voltage	V_C	$V_{CC} = 2.5V$	0.2	1.25	2.3	V
		$V_{CC} = 3.3V$	0.3	1.65	3.0	
Frequency Deviation	$\Delta f/f_0$	$V_C = 0.2V$	-60 to -180		ppm	
		$V_C = 2.3V$	60 to 180			
		$V_C = 0.3V$	-60 to -180		ppm	
		$V_C = 3.0V$	60 to 180			
Linearity	L	Best Straight Line Fit	-	-	±15	%
Gain Transfer	K_V	Pull Sensitivity; @ +1.25V, +25°C	-	80	260	ppm/V
		Pull Sensitivity; @ +1.65V, +25°C	-	-	-	
Input Impedance	Z_{Vc}	-	1	-	-	MOhms
Modulation Roll-off	-	@ -3dB	10	-	-	kHz
Transfer Function	-	-	-	Positive	-	-

Enable Truth Table

Pin 2	Pin 4
Logic '1'	Output
Open	Output
Logic '0'	High Imp.

Test Circuit

HCMOS



Output Waveform

HCMOS

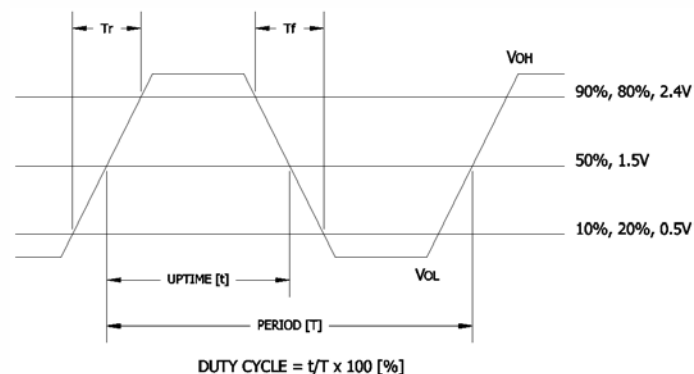

Electrical Specifications

Performance Data

Phase Noise [typical]

125MHz, HCMOS, $V_{CC} = +3.3V$, $V_C = +1.65V$, $T_A = +25^\circ C$

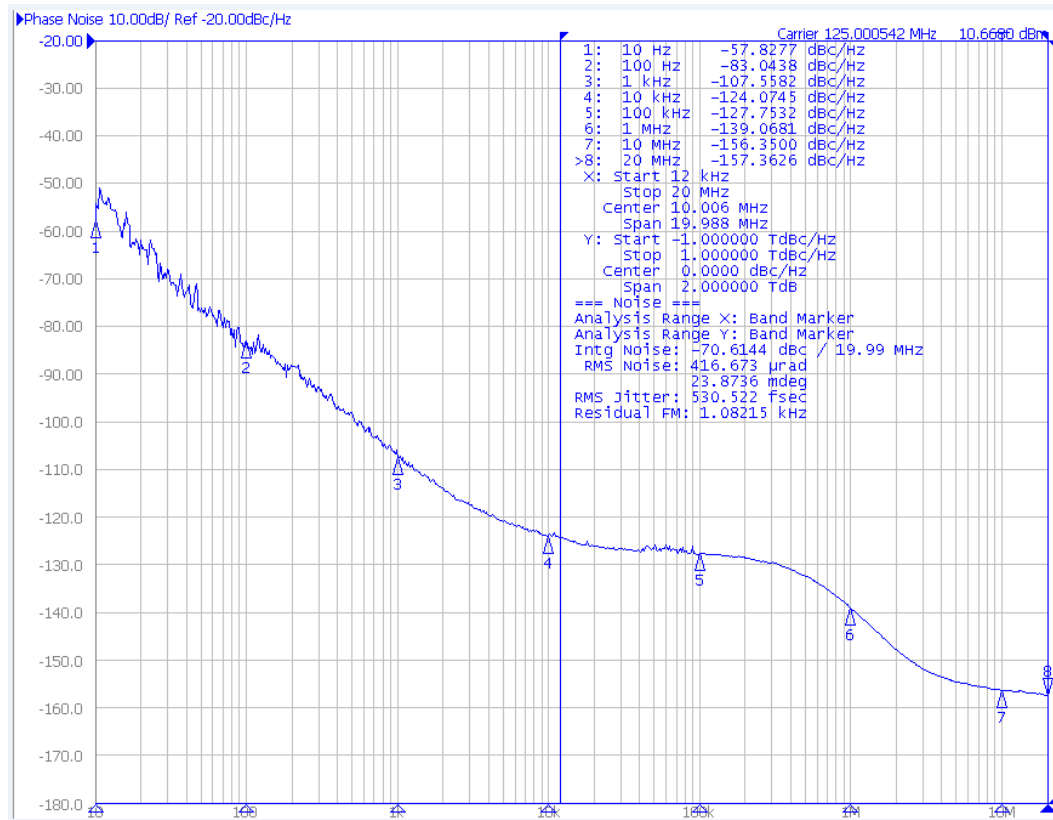

Phase Noise Tabulated

125MHz, HCMOS, $V_{CC} = +3.3V$, $V_C = +1.65V$, $T_A = +25^\circ C$

PARAMETER	SYMBOL	CONDITIONS	TYP	UNIT
HCMOS @ 125.00MHz				
Phase Noise		Single Side Band		
		@ 10Hz	-57.8277	
		@ 100Hz	-83.0438	
		@ 1kHz	-107.5582	
	-	@ 10kHz	-124.0745	dBc/Hz
		@ 100kHz	-127.7532	
		@ 1MHz	-139.0681	
		@ 10MHz	-156.3500	
	@ 20MHz	-157.3626		
Phase Jitter, RMS	tjrms	Integration Bandwidth 12kHz - 20MHz	530.5330	fs

Mechanical Specifications

Package Drawing

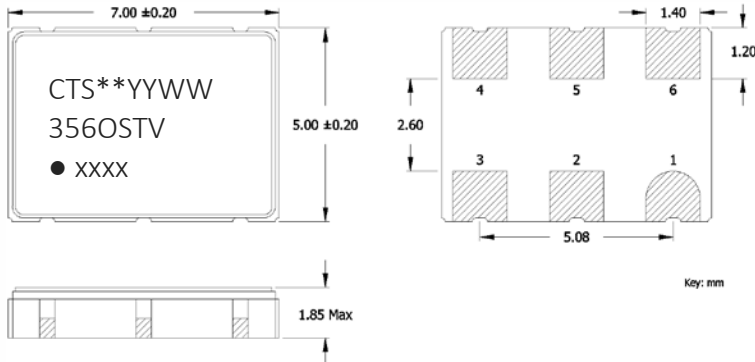

Marking Information

1. ** – Manufacturing Site Code.
2. YYWW – Date Code; YY = year, WW = week.
3. O – Output Type; C = HCMOS.
4. ST – Frequency Stability/Temperature Code. [Refer to Ordering Information]
5. V – Voltage Code; 3 = 3.3V, 2 = 2.5V.
6. xxxx – Frequency Code.
3-digits, frequencies below 100MHz
4-digits, frequencies 100MHz or greater
[See document 016-1454-0, Frequency Code Tables.]

Recommended Pad Layout

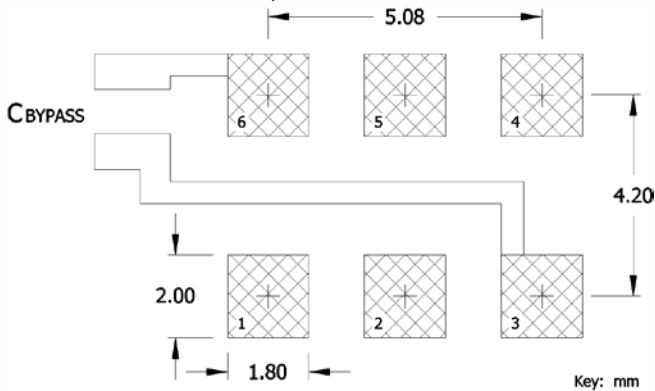

Notes

1. JEDEC termination code (e4). Barrier-plating is nickel [Ni] with gold [Au] flash plate.
2. Reflow conditions per JEDEC J-STD-020; +260°C maximum, 20 seconds.
3. MSL = 1.

Pin Assignments

Pin	Symbol	Function
1	V _C	Voltage Control
2	EOH	Enable [tri-state]
3	GND	Circuit & Package Ground
4	Output	RF Output
5	N.C.	No Connect
6	V _{CC}	Supply Voltage

Table I - Date Code

YEAR		MONTH															
		JAN	FEB	MAR	APR	MAY	JUN	JUL	AUG	SEP	OCT	NOV	DEC				
2001	2005	2009	2013	2017	A	B	C	D	E	F	G	H	J	K	L	M	
2002	2006	2010	2014	2018	N	P	Q	R	S	T	U	V	W	X	Y	Z	
2003	2007	2011	2015	2019	a	b	c	d	e	f	g	h	j	k	l	m	
2004	2008	2012	2016	2020	n	p	q	r	s	t	u	v	w	x	y	z	

Packaging - Tape and Reel

Tape Drawing

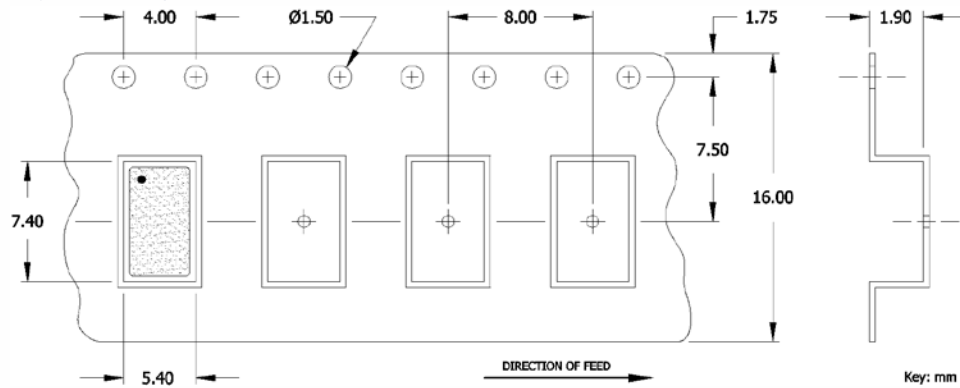

Reel Drawing

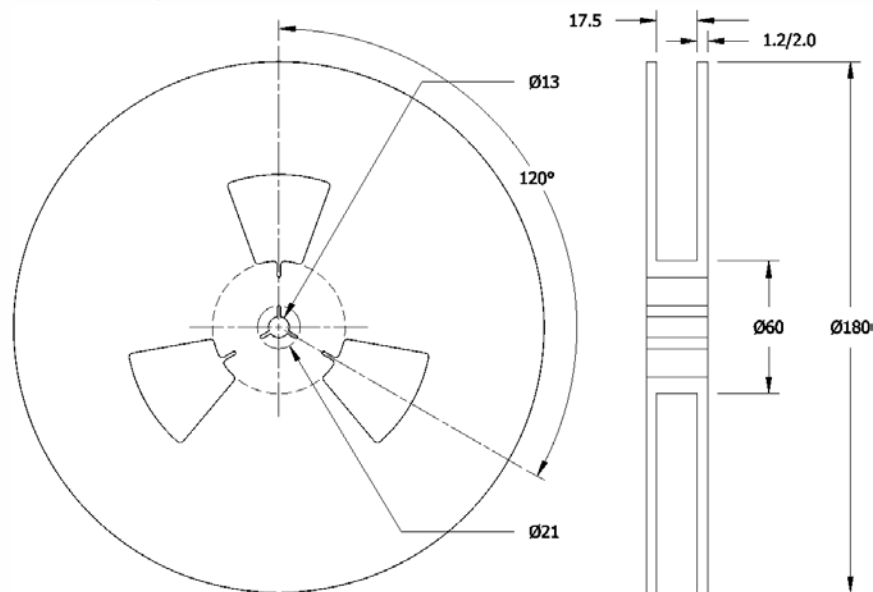

Notes

1. Device quantity is 1k pieces per 180mm reel.
2. Complete CTS part number, frequency value and date code information must appear on reel and carton labels.



Addendum

Additional Developed Frequencies – MHz

FREQUENCY	FREQUENCY CODE	FREQUENCY	FREQUENCY CODE	FREQUENCY	FREQUENCY CODE	FREQUENCY	FREQUENCY CODE
27.000000	270	62.500000	625	106.250000	1062	156.253906	156A
38.840000	38D	74.175800	74A	132.000000	1320	160.000000	1600
38.880000	388	76.800000	768	144.500000	1445	184.320000	1843
43.350000	433	86.700000	867	148.351648	148B		
45.000000	450	87.351542	873	150.000000	1500		
54.000000	540	92.160000	921	153.600000	1536		

Frequency Codes for Cover Page Table – MHz

FREQUENCY	FREQUENCY CODE	FREQUENCY	FREQUENCY CODE	FREQUENCY	FREQUENCY CODE
25.000000	250	122.880000	1228	200.000000	2000
50.000000	500	125.000000	1250	250.000000	2500
74.250000	742	148.500000	1485		
77.760000	777	155.520000	1555		
100.000000	1000	156.250000	1562		