

Specifications

- Current rating:3A AC,DC
- Voltage rating:250V AC,DC
- Temperature range:-40°C~+105°C
- Contact resistance:20mΩMax.
- Insulation resistance:1000MΩMin.
- Withstanding voltage:1000V AC/minute
- *Compliant with RoHS and REACH*
- *Meet the HF/Halogen Free,need to customize*
- *Contact CJT for details*

Standards



Assembly layout

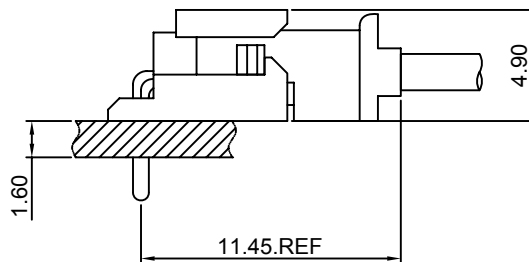
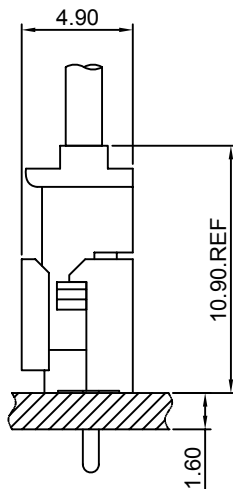

A2505-T

2.50mm pitch Crimp Terminal

Reference Informations:

*Used in CJT A2505 series Housing

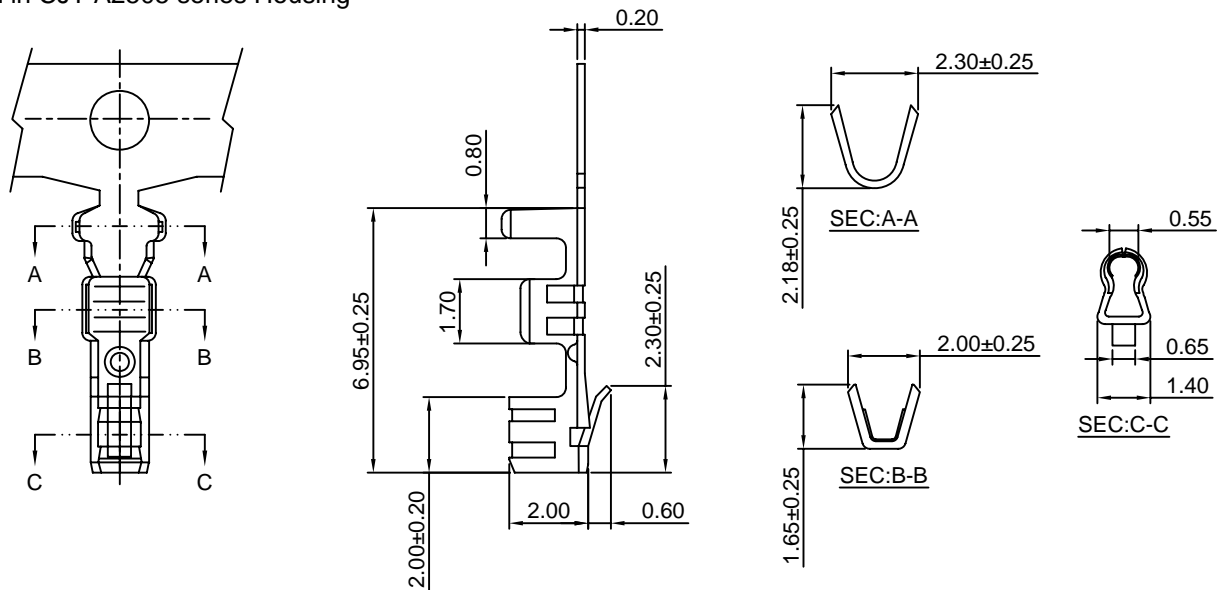

Ordering information & Specifications:

Unit:mm

Part NO	Wire Range	Insulation O.D.	Material	Finish	Qty/reel
A2505-TP	AWG#22-#28	1.90mm(max)	Phosphor Bronze	Tin over Nickel	10,000 PCS
A2505-GP	AWG#22-#28	1.90mm(max)	Phosphor Bronze	Gold over Nickel	10,000 PCS

Optional Gold plating available but MOQ requested

A2505H

2.50mm pitch Housing

Reference Informations:

*Material:Nylon 66,UL94V-0

*Suitable CJT A2505 series Terminal

*Mates with CJT A2505 series Wafer

*Color:Beige

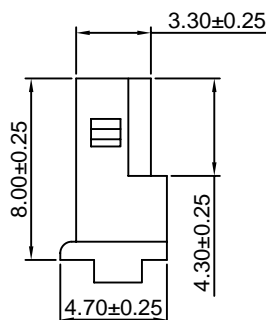
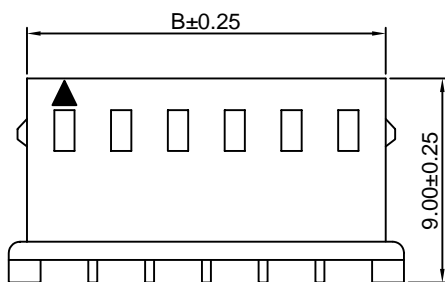
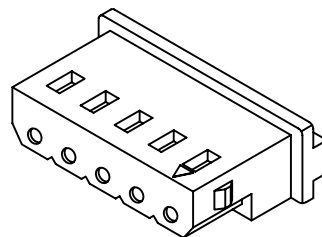
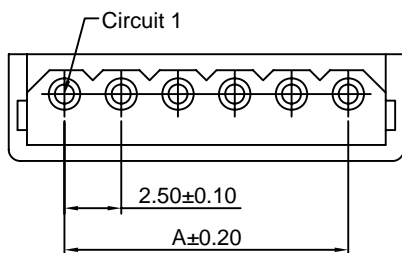

Ordering Information & Dimensions

PART NO.	Dimensions	
	A	B
A2505H-2P	2.50	5.80
A2505H-3P	5.00	8.30
A2505H-4P	7.50	10.80
A2505H-5P	10.00	13.30
A2505H-6P	12.50	15.80
A2505H-7P	15.00	18.30
A2505H-8P	17.50	20.80
A2505H-9P	20.00	23.30
A2505H-10P	22.50	25.80
A2505H-11P	25.00	28.30
A2505H-12P	27.50	30.80
A2505H-13P	30.00	33.30
A2505H-14P	32.50	35.80
A2505H-15P	35.00	38.30
A2505H-16P	37.00	40.80
A2505H-17P	39.50	43.30
A2505H-18P	42.00	45.80
A2505H-19P	44.50	48.30
A2505H-20P	47.00	50.80

Unit: mm

A2505WV

2.50mm pitch 180° Wafer

Reference Informations:

- *Material:Pin:Brass/Tin over Nickel
Insulator:Nylon 66,UL94V-0
- *Mates with CJT A2505 series Housing
- *Color:Beige

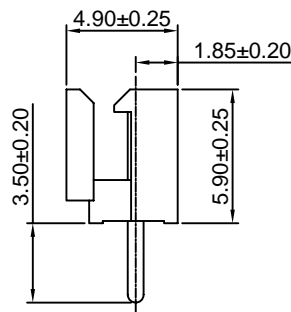
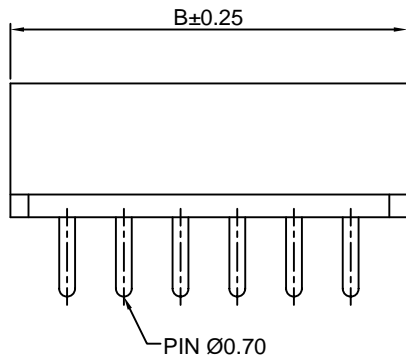
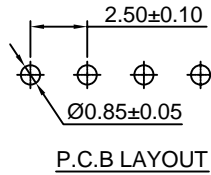
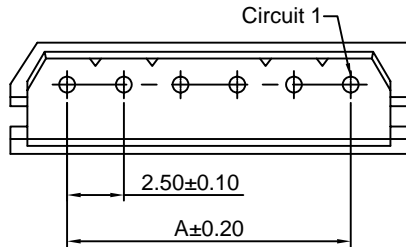

Ordering Information & Dimensions

PART NO.	Dimensions	
	A	B
A2505WV-2P	2.50	7.50
A2505WV-3P	5.00	10.00
A2505WV-4P	7.50	12.50
A2505WV-5P	10.00	15.00
A2505WV-6P	12.50	17.50
A2505WV-7P	15.00	20.00
A2505WV-8P	17.50	22.50
A2505WV-9P	20.00	25.00
A2505WV-10P	22.50	27.50
A2505WV-11P	25.00	30.00
A2505WV-12P	27.50	32.50
A2505WV-13P	30.00	35.00
A2505WV-14P	32.50	37.50
A2505WV-15P	35.00	40.00
A2505WV-16P	37.50	42.50
A2505WV-17P	40.00	45.00
A2505WV-18P	42.50	47.50
A2505WV-19P	45.00	50.00
A2505WV-20P	47.50	52.50

Unit: mm

A2505WR

2.50mm pitch 90° Wafer

Reference Informations:

- *Material:Pin:Brass/Tin over Nickel
Insulator:Nylon 66,UL94V-0
- *Mates with CJT A2505 series Housing
- *Color:Beige

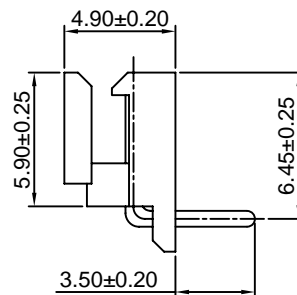
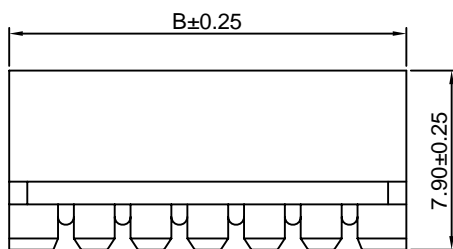
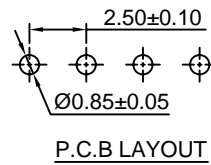
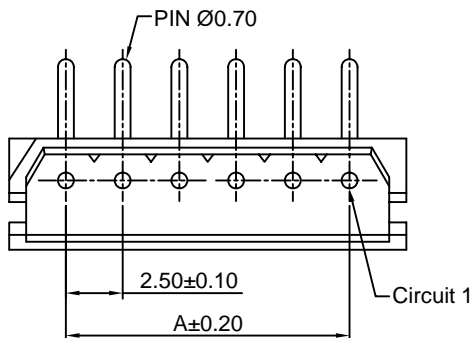

Ordering Information & Dimensions

PART NO.	Dimensions	
	A	B
A2505WR-2P	2.50	7.50
A2505WR-3P	5.00	10.00
A2505WR-4P	7.50	12.50
A2505WR-5P	10.00	15.00
A2505WR-6P	12.50	17.50
A2505WR-7P	15.00	20.00
A2505WR-8P	17.50	22.50
A2505WR-9P	20.00	25.00
A2505WR-10P	22.50	27.50
A2505WR-11P	25.00	30.00
A2505WR-12P	27.50	32.50
A2505WR-13P	30.00	35.00
A2505WR-14P	32.50	37.50
A2505WR-15P	35.00	40.00
A2505WR-16P	37.50	42.50
A2505WR-17P	40.00	45.00
A2505WR-18P	42.50	47.50
A2505WR-19P	45.00	50.00
A2505WR-20P	47.50	52.50

Unit: mm