

»Features

- 800Watts peak pulse power ($t_p = 8/20\mu s$)
- Protects two line pairs
- Low clamping voltage
- Low leakage current
- Low capacitance ($C_j=3.0\text{ pF}$)
- Protects Up To Two Bidirectional I/O Lines
- IEC 61000-4-2 $\pm 30\text{ kV}$ contact $\pm 30\text{ kV}$ air
- IEC 61000-4-4 (EFT) 40A (5/50ns)
- IEC 61000-4-5 (Lightning) 40A (8/20 μs)

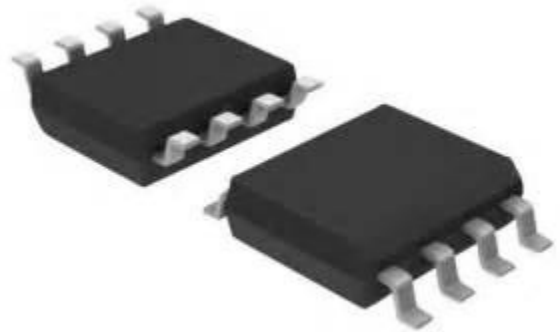

»Applications

- 100/1000 Ethernet
- Integrated magnetics/RJ-45 connectors
- LAN/WAN Equipment
- Security Cameras
- Industrial Controls
- Peripherals
- Notebooks & Desktop Computers

»Mechanical Data

- SOP8 package
- Molding compound flammability rating: UL 94V-0
- Packaging: Tape and Reel
- RoHS/WEEE Compliant

»Schematic & PIN Configuration

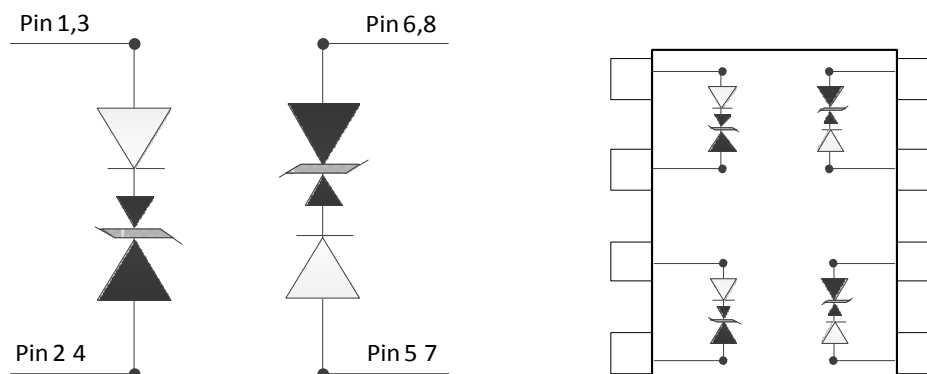

»Absolute Maximum Rating

Rating	Symbol	Value	Units
Peak Pulse Power ($t_p = 8/20\mu s$)	P_{PP}	800	Watts
Peak Pulse Current ($t_p = 8/20\mu s$) (note1)	I_{pp}	40	A
ESD per IEC 61000-4-2 (Air) ESD per IEC 61000-4-2 (Contact)	V_{ESD}	30 30	kV
Lead Soldering Temperature	T_L	260(10seconds)	°C
Junction Temperature	T_J	-55 to + 125	°C
Storage Temperature	T_{stg}	-55 to + 125	°C

»Electrical Characteristics

Parameter	Symbol	Conditions	Min	Typical	Max	Units
Reverse Stand-Off Voltage	V_{RWM}				2.8	V
Reverse Breakdown Voltage	V_{BR}	$I_T = 1mA$	3.0			V
Snap-Back Voltage	V_{SB}	$I_{SB} = 50mA$	2.8			V
Reverse Leakage Current	I_R	$V_{RWM} = 2.8V, T = 25^\circ C$		50	500	nA
Clamping Voltage	V_C	$I_{PP} = 40A, t_p = 8/20\mu s$		20		V
Junction Capacitance	C_j	$V_R = 0V, f = 1MHz$ Each line		3.0		pF

»Electrical Parameters (TA = 25°C unless otherwise noted)

Symbol	Parameter
I_{PP}	Maximum Reverse Peak Pulse Current
V_C	Clamping Voltage @ I_{PP}
V_{RWM}	Working Peak Reverse Voltage
I_R	Maximum Reverse Leakage Current @ V_{RWM}
V_{PT}	Punch-through Breakdown Voltage @ I_T
V_{SB}	Snap-Back Voltage @ I_{SB}
I_{SB}	Snap-Back Current

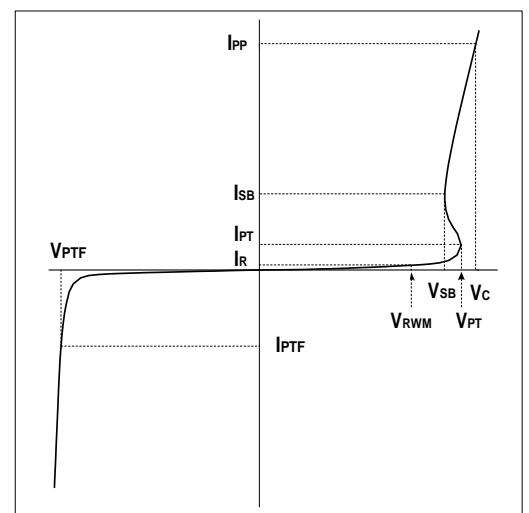

Note: 8/20µs pulse waveform.

»Typical Characteristics

Figure 1: Peak Pulse Power vs. Pulse Time

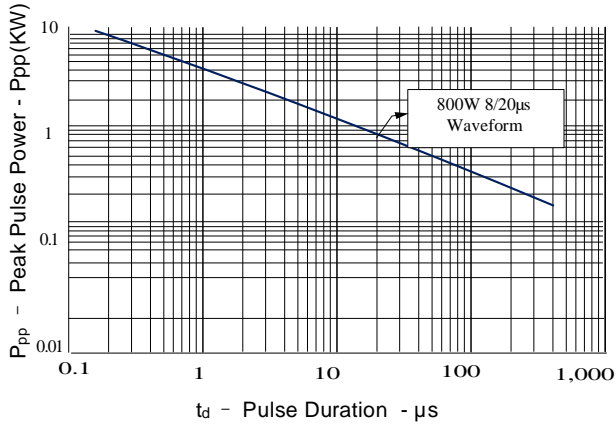

Figure 2: Power Derating Curve

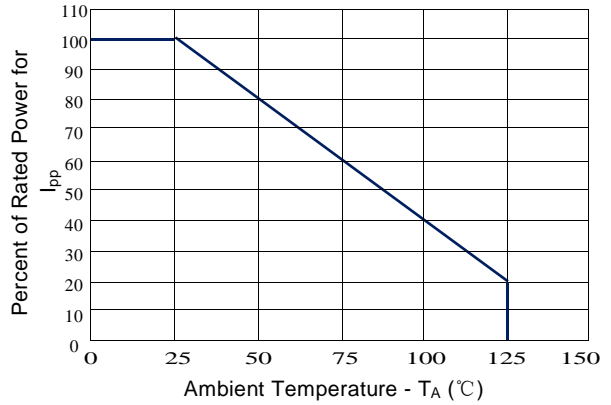

Figure3: Pulse Waveform

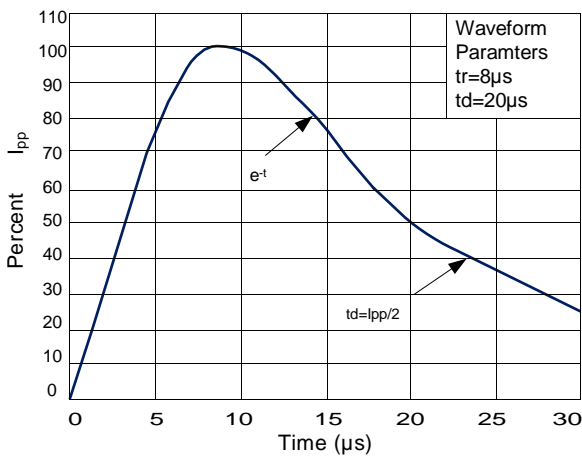
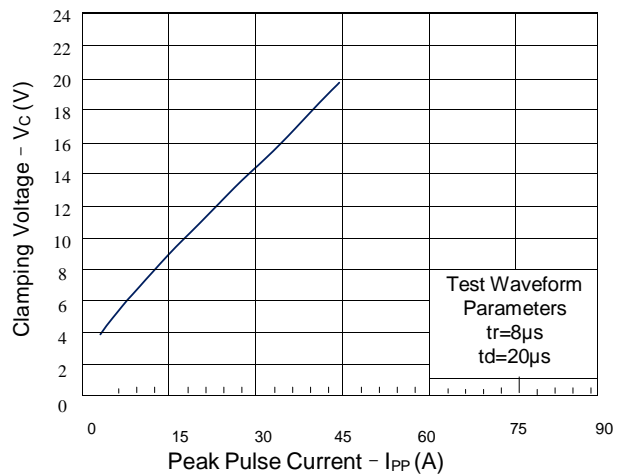
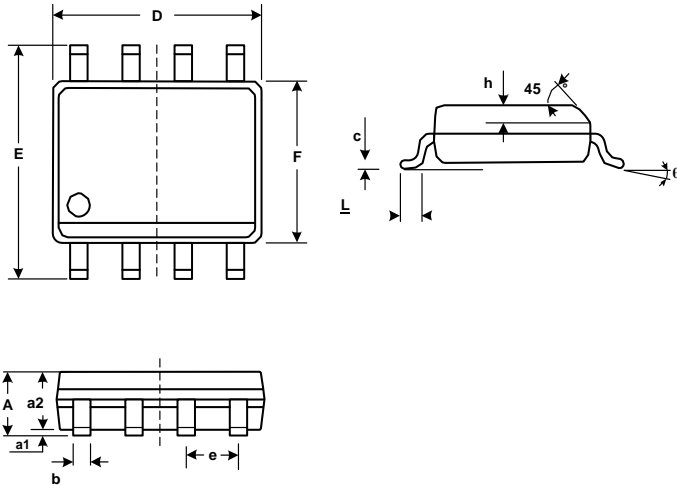

Figure 4: Clamping Voltage vs. Peak Pulse Current



»Outline Drawing – SOP8



DIMENSIONS				
SYMBOL	INCHES		MILIMETER	
	MIN	MAX	MIN	MAX
A	0.053	0.069	1.35	1.75
a1	0.004	0.010	0.10	0.25
a2	0.049	0.065	1.25	1.65
D	0.189	0.197	4.80	5.00
F	0.150	0.157	3.80	4.00
E	0.236BSC		6.00BSC	
b	0.012	0.020	0.31	0.51
e	0.050BSC		1.27BSC	
h	0.010	0.020	0.25	0.50
c	0.007	0.010	0.17	0.25
L	0.016	0.041	0.40	1.04
θ	0°	8°	0°	8°

»Marking

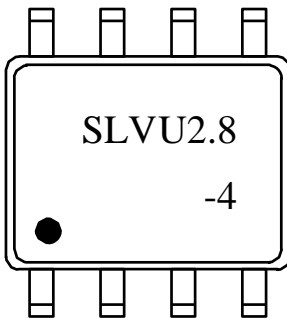

»Ordering information

Order code	Package	Base qty	Delivery mode
SLVU2.8-4N	SOP8	2500	Tape and reel