

30MHz, 240µA Power Efficient Rail-to-Rail I/O Op Amps

FEATURES

- Gain Bandwidth Product: 30MHz
- Low Quiescent Current: 240µA
- Op Amp Drives up to 1nF Capacitive Loads
- Offset Voltage: 400µV Maximum
- Rail-to-Rail Input and Output
- Supply Voltage Range: 1.8V to 5.25V
- Input Bias Current: 100nA Maximum
- CMRR/PSRR: 100dB/95dB
- Shutdown Current: 10µA Maximum
- Operating Temperature Range: -40°C to 125°C
- Single in 6-Lead TSOT-23, 2mm × 2mm DFN Packages
- Dual in 8-Lead MS8, MS10, TSOT-23, 2mm × 2mm DFN Packages
- Quad in MS16 Package

APPLICATIONS

- Micropower Active Filters
- Portable Instrumentation
- Battery or Solar Powered Systems
- Automotive Electronics

DESCRIPTION

The **LTC®6261/LTC6262/LTC6263** are single/dual/quad operational amplifiers with low noise, low power, low supply voltage, and rail-to-rail inputs and outputs. They are unity gain stable with capacitive loads up to 1nF. They feature 30MHz gain-bandwidth product, 7V/µs slew rate while consuming only 240µA of supply current per amplifier operating on supply voltages ranging from 1.8V to 5.25V. The combination of low supply current, low supply voltage, high gain bandwidth product and low noise makes the LTC6261 family unique among rail-to-rail input/output op amps with similar supply current. These operational amplifiers are ideal for low power and low noise applications.

For applications that require power-down, the LTC6261 and LTC6262 in MSOP-10 offer shutdown which reduces the current consumption to 10µA maximum.

The LTC6261 family can be used as plug-in replacements for many commercially available op amps to reduce power and improve input/output range and performance.

LT, LT, LTC, LTM, Linear Technology and the Linear logo are registered trademarks and Over-The-Top and C-Load are trademarks of Analog Devices, Inc. All other trademarks are the property of their respective owners.

TYPICAL APPLICATION

Low Power, Low Distortion ADC Driver

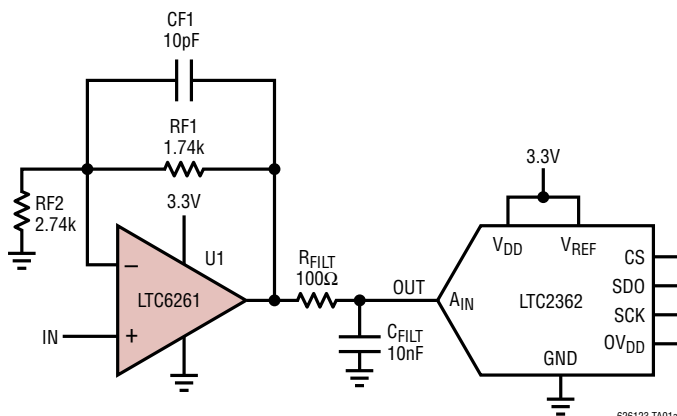

LTC6261 Driving LTC2362 ADC

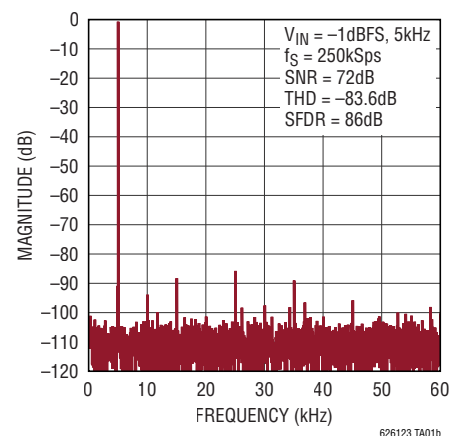

LTC6261/LTC6262/LTC6263

ABSOLUTE MAXIMUM RATINGS

(Note 1)

Supply Voltage: $V^+ - V^-$	5.5V
Input Voltage	$V^- - 0.2$ to $V^+ + 0.2$
Input Current: +IN, -IN, $\overline{\text{SHDN}}$ (Note 2)	$\pm 10\text{mA}$
Output Current: OUT	$\pm 20\text{mA}$
Output Short-Circuit Duration (Note 3)	Indefinite
Operating Temperature Range (Note 4)	
LTC6261I/LTC6262I/LTC6263I	-40°C to 85°C
LTC6261H/LTC6262H/LTC6263H	-40°C to 125°C

Specified Temperature Range (Note 5)

LTC6261I/LTC6262I/LTC6263I	-40°C to 85°C
LTC6261H/LTC6262H/LTC6263H	-40°C to 125°C
Maximum Junction Temperature	150°C
Storage Temperature Range	-65°C to 150°C
Lead Temperature (Soldering, 10 sec)	
TS8, MS8, MS only	300°C

PIN CONFIGURATION

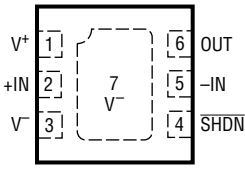
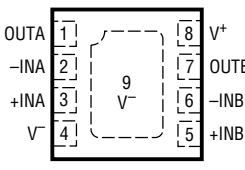
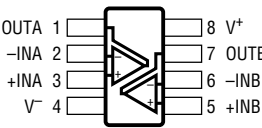
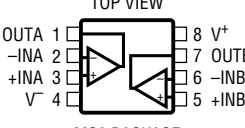
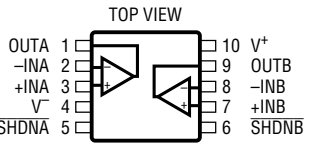
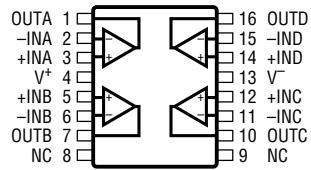
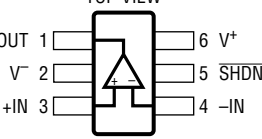
<p style="text-align: center;">TOP VIEW</p>  <p style="text-align: center;">DC PACKAGE 6-LEAD (2mm × 2mm × 0.8mm) PLASTIC DFN</p> <p style="text-align: center;">$T_{\text{JMAX}} = 150^\circ\text{C}$, $\theta_{\text{JA}} = 80^\circ\text{C/W}$ (NOTE 6) EXPOSED PAD (PIN 7) IS V^-, MUST BE SOLDERED TO PCB</p>	<p style="text-align: center;">TOP VIEW</p>  <p style="text-align: center;">DC PACKAGE 8-LEAD (2mm × 2mm × 0.8mm) PLASTIC DFN</p> <p style="text-align: center;">$T_{\text{JMAX}} = 150^\circ\text{C}$, $\theta_{\text{JA}} = 80^\circ\text{C/W}$ (NOTE 6) EXPOSED PAD (PIN 9) IS V^-, MUST BE SOLDERED TO PCB</p>
<p style="text-align: center;">TOP VIEW</p>  <p style="text-align: center;">TS8 PACKAGE 8-LEAD PLASTIC TSOT-23</p> <p style="text-align: center;">$T_{\text{JMAX}} = 150^\circ\text{C}$, $\theta_{\text{JA}} = 195^\circ\text{C/W}$ (NOTE 6)</p>	<p style="text-align: center;">TOP VIEW</p>  <p style="text-align: center;">MS8 PACKAGE 8-LEAD PLASTIC MSOP</p> <p style="text-align: center;">$T_{\text{JMAX}} = 150^\circ\text{C}$, $\theta_{\text{JA}} = 163^\circ\text{C/W}$ (NOTE 6)</p>
<p style="text-align: center;">TOP VIEW</p>  <p style="text-align: center;">MS PACKAGE 10-LEAD PLASTIC MSOP</p> <p style="text-align: center;">$T_{\text{JMAX}} = 150^\circ\text{C}$, $\theta_{\text{JA}} = 160^\circ\text{C/W}$ (NOTE 6)</p>	<p style="text-align: center;">TOP VIEW</p>  <p style="text-align: center;">MS PACKAGE 16-LEAD PLASTIC MSOP</p> <p style="text-align: center;">$T_{\text{JMAX}} = 150^\circ\text{C}$, $\theta_{\text{JA}} = 125^\circ\text{C/W}$ (NOTE 6)</p>
<p style="text-align: center;">TOP VIEW</p>  <p style="text-align: center;">S6 PACKAGE 6-LEAD PLASTIC TSOT-23</p> <p style="text-align: center;">$T_{\text{JMAX}} = 150^\circ\text{C}$, $\theta_{\text{JA}} = 192^\circ\text{C/W}$ (NOTE 6)</p>	

ORDER INFORMATION

<http://www.linear.com/product/LTC6261#orderinfo>

TAPE AND REEL (MINI)	TAPE AND REEL	PART MARKING*	PACKAGE DESCRIPTION	SPECIFIED TEMPERATURE RANGE
LTC6261IS6#TRMPBF	LTC6261IS6#TRPBF	LTGWF	6-Lead Plastic TSOT-23	-40°C to 85°C
LTC6261HS6#TRMPBF	LTC6261HS6#TRPBF	LTGWF	6-Lead Plastic TSOT-23	-40°C to 125°C
LTC6261IDC#TRMPBF	LTC6261IDC#TRPBF	LGZT	6-Lead (2mm × 2mm × 0.8mm) Plastic DFN	-40°C to 85°C
LTC6261HDC#TRMPBF	LTC6261HDC#TRPBF	LGZT	6-Lead (2mm × 2mm × 0.8mm) Plastic DFN	-40°C to 125°C
LTC6262ITS8#TRMPBF	LTC6262ITS8#TRPBF	LTGWK	8-Lead Plastic TSOT-23	-40°C to 85°C
LTC6262HTS8#TRMPBF	LTC6262HTS8#TRPBF	LTGWK	8-Lead Plastic TSOT-23	-40°C to 125°C
LTC6262IDC#TRMPBF	LTC6262IDC#TRPBF	LGWG	8-Lead (2mm × 2mm × 0.8mm) Plastic DFN	-40°C to 85°C
LTC6262HDC#TRMPBF	LTC6262HDC#TRPBF	LGWG	8-Lead (2mm × 2mm × 0.8mm) Plastic DFN	-40°C to 125°C
LTC6262IMS8#PBF	LTC6262IMS8#TRPBF	LTGWJ	8-Lead Plastic MSOP	-40°C to 85°C
LTC6262HMS8#PBF	LTC6262HMS8#TRPBF	LTGWJ	8-Lead Plastic MSOP	-40°C to 125°C
LTC6262IMS#PBF	LTC6262IMS#TRPBF	LTGWM	10-Lead Plastic MSOP	-40°C to 85°C
LTC6262HMS#PBF	LTC6262HMS#TRPBF	LTGWM	10-Lead Plastic MSOP	-40°C to 125°C
LTC6263IMS#PBF	LTC6263IMS#TRPBF	6263	16-Lead Plastic MSOP	-40°C to 85°C
LTC6263HMS#PBF	LTC6263HMS#TRPBF	6263	16-Lead Plastic MSOP	-40°C to 125°C

Consult LTC Marketing for parts specified with wider operating temperature ranges. *The temperature grade is identified by a label on the shipping container. Parts ending with PBF are RoHS and WEEE compliant.

For more information on lead free part marking, go to: <http://www.linear.com/leadfree/>

For more information on tape and reel specifications, go to: <http://www.linear.com/tapeandree/>.

5V ELECTRICAL CHARACTERISTICS

The ● denotes the specifications which apply over the full operating temperature range, otherwise specifications are at $T_A = 25^\circ\text{C}$. $V_{\text{SUPPLY}} = 5\text{V}$, $V_{\text{CM}} = V_{\text{OUT}} = V_{\text{SUPPLY}}/2$, $C_L = 10\text{pF}$, V_{SHDN} is unconnected.

SYMBOL	PARAMETER	CONDITIONS	MIN	TYP	MAX	UNITS
V_{OS}	Input Offset Voltage	$V_{\text{CM}} = V^- + 0.3\text{V}$ (PNP Region)	● -400	50	400	μV
			-1000		1000	μV
		$V_{\text{CM}} = V^+ - 0.3\text{V}$ (NPN Region)	● -400	50	400	μV
			-1000		1000	μV
$V_{\text{OS TC}}$	Input Offset Voltage Drift	$V_{\text{CM}} = V^- + 0.3\text{V}, V^+ - 0.3\text{V}$	●	0.4		$\mu\text{V}/^\circ\text{C}$
I_{B}	Input Bias Current (Note 7)	$V_{\text{CM}} = V^- + 0.3\text{V}$	● -100	-60	50	nA
			-150		150	nA
		$V_{\text{CM}} = V^+ - 0.3\text{V}$	● -50	10	50	nA
			-150		150	nA
I_{OS}	Input Offset Current	$V_{\text{CM}} = V^- + 0.3\text{V}$	● -50	2	50	nA
			-100		100	nA
		$V_{\text{CM}} = V^+ - 0.3\text{V}$	● -50	2	50	nA
			-100		100	nA
e_{n}	Input Voltage Noise Density	$f = 1\text{kHz}$		13		$\text{nV}/\sqrt{\text{Hz}}$
	Input Noise Voltage	$f = 0.1\text{Hz to }10\text{Hz}$		1.25		$\mu\text{V}_{\text{P-P}}$

LTC6261/LTC6262/LTC6263

5V ELECTRICAL CHARACTERISTICS The ● denotes the specifications which apply over the full operating temperature range, otherwise specifications are at $T_A = 25^\circ\text{C}$. $V_{\text{SUPPLY}} = 5\text{V}$, $V_{\text{CM}} = V_{\text{OUT}} = V_{\text{SUPPLY}}/2$, $C_L = 10\text{pF}$, V_{SHDN} is unconnected.

SYMBOL	PARAMETER	CONDITIONS	MIN	TYP	MAX	UNITS
i_n	Input Current Noise Density	$f = 1\text{kHz}$, $V_{\text{CM}} = 0\text{V to } 4\text{V}$ (PNP Input)		600		$\text{fA}/\sqrt{\text{Hz}}$
		$f = 1\text{kHz}$, $V_{\text{CM}} = 4\text{V to } 5\text{V}$ (NPN Input)		600		$\text{fA}/\sqrt{\text{Hz}}$
R_{IN}	Input Resistance	Differential		1		$\text{M}\Omega$
		Common Mode		10		$\text{M}\Omega$
C_{IN}	Input Capacitance	Differential		0.4		pF
		Common Mode		0.3		pF
CMRR	Common Mode Rejection Ratio	$V_{\text{CM}} = 0.3\text{V to } 3.5\text{V}$	●	68	100	dB
		$V_{\text{CM}} = -0.1\text{V to } 5.1\text{V}$	●	70	95	dB
IVR	Input Voltage Range		●	-0.1	5.1	V
PSRR	Power Supply Rejection Ratio	$V_{\text{CM}} = 0.4\text{V}$, V_S Ranges from 1.8V to 5V	●	80	95	dB
			●	74		dB
	Supply Voltage Range		●	1.8	5.25	V
A_V	Large Signal Gain	$V_{\text{OUT}} = 0.5\text{V to } 4.5\text{V}$, $R_{\text{LOAD}} = 10\text{k}$	●	100	200	V/mV
		$V_{\text{OUT}} = 0.5\text{V to } 4.5\text{V}$, $R_{\text{LOAD}} = 1\text{k}$	●	15		V/mV
V_{OL}	Output Swing Low (Input Overdrive 30mV). Measured from V^-	No Load	●	35	120	mV
		$I_{\text{SINK}} = 100\mu\text{A}$	●	50	120	mV
		$I_{\text{SINK}} = 1\text{mA}$	●	100	170	mV
V_{OH}	Output Swing High (Input Overdrive 30mV). Measured from V^+	No Load	●	60	130	mV
		$I_{\text{SOURCE}} = 100\mu\text{A}$	●	70	140	mV
		$I_{\text{SOURCE}} = 1\text{mA}$	●	95	150	mV
I_{SC}	Output Short-Circuit Current		●	30	40	mA
			●	20		mA
I_S	Supply Current per Amplifier		●	215	245	μA
			●	160	300	μA
	Supply Current in Shutdown		●	5	7	μA
			●		10	μA
I_{SHDN}	Shutdown Pin Current	$V_{\text{SHDN}} = 0.6\text{V}$	●	40	150	nA
		$V_{\text{SHDN}} = 1.5\text{V}$	●	-10	2	130
V_{IL}	SHDN Input Low Voltage	Disable	●		0.6	V
V_{IH}	SHDN Input High Voltage	Enable	●	1.5		V
t_{ON}	Turn-On Time	SHDN Toggle from 0V to 5V		15		μs
t_{OFF}	Turn-Off Time	SHDN Toggle from 5V to 0V		6		μs
GBW	Gain-Bandwidth Product	$f = 200\text{kHz}$	●	20	30	MHz
			●	15		MHz
t_S	Settling Time, 0.5V to 4.5V, Unity Gain	0.1%		0.4		μs
		0.01%		0.5		μs
SR	Slew Rate	$A_V = -1$, $V_{\text{OUT}} = 0.5\text{V to } 4.5\text{V}$, $C_{\text{LOAD}} = 10\text{pF}$, $R_F = R_G = 10\text{k}\Omega$	●	4.5	7	$\text{V}/\mu\text{s}$
			●	3.5	16	$\text{V}/\mu\text{s}$
FPBW	Full Power Bandwidth (Note 8)	$4V_{\text{P-P}}$		560		kHz
THD+N	Total Harmonic Distortion and Noise	$f = 1\text{kHz}$, $A_V = 2$, $R_L = 4\text{k}\Omega$, $V_{\text{OUTP-P}} = 1\text{V}$, $V_{\text{IN}} = 2.25\text{V to } 2.75\text{V}$		0.0012		%
				98		dB
I_{LEAK}	Output Leakage Current in Shutdown	$V_{\text{SHDN}} = 0\text{V}$, $V_{\text{OUT}} = 0\text{V}$	●	-100	100	nA
		$V_{\text{SHDN}} = 0\text{V}$, $V_{\text{OUT}} = 5\text{V}$	●	-100	100	nA

1.8V ELECTRICAL CHARACTERISTICS

The ● denotes the specifications which apply over the full operating temperature range, otherwise specifications are at $T_A = 25^\circ\text{C}$. $V_{\text{SUPPLY}} = 1.8\text{V}$, $V_{\text{CM}} = V_{\text{OUT}} = 0.4\text{V}$, $C_L = 10\text{pF}$, V_{SHDN} is unconnected.

SYMBOL	PARAMETER	CONDITIONS	MIN	TYP	MAX	UNITS
V_{OS}	Input Offset Voltage	$V_{\text{CM}} = V^- + 0.3\text{V}$	● -400	100	400	μV
			-1000		1000	μV
		$V_{\text{CM}} = V^+ - 0.3\text{V}$	● -400	100	400	μV
			-1000		1000	μV
$V_{\text{OS TC}}$	Input Offset Voltage Drift	$V_{\text{CM}} = V^- + 0.3\text{V}, V^+ - 0.3\text{V}$	●	0.4		$\mu\text{V}/^\circ\text{C}$
I_{B}	Input Bias Current (Note 7)	$V_{\text{CM}} = V^- + 0.3\text{V}$	● -100	-10	100	nA
			-150		150	nA
		$V_{\text{CM}} = V^+ - 0.3\text{V}$	● -50	10	50	nA
			-150		150	nA
I_{OS}	Input Offset Current	$V_{\text{CM}} = V^- + 0.3\text{V}$	● -150		150	nA
		$V_{\text{CM}} = V^+ - 0.3\text{V}$	● -150		150	nA
e_{n}	Input Voltage Noise Density	$f = 1\text{kHz}, V_{\text{CM}} = 0.4\text{V}$		13		$\text{nV}/\sqrt{\text{Hz}}$
	Input Noise Voltage	$f = 0.1\text{Hz to } 10\text{Hz}$		1.25		$\mu\text{V}_{\text{P-P}}$
i_{n}	Input Current Noise Density	$f = 1\text{kHz}, V_{\text{CM}} = 0\text{V to } 0.8\text{V}$ (PNP Input)		600		$\text{fA}/\sqrt{\text{Hz}}$
		$f = 1\text{kHz}, V_{\text{CM}} = 1\text{V to } 1.8\text{V}$ (NPN Input)		600		$\text{fA}/\sqrt{\text{Hz}}$
R_{IN}	Input Resistance	Differential		1		$\text{M}\Omega$
		Common Mode		10		$\text{M}\Omega$
C_{IN}	Input Capacitance	Differential		0.4		pF
		Common Mode		0.3		pF
CMRR	Common Mode Rejection Ratio	$V_{\text{CM}} = 0.2\text{V to } 1.6\text{V}$	● 70	90		dB
			62			dB
IVR	Input Voltage Range		● -0.1		1.9	V
PSRR	Power Supply Rejection Ratio	$V_{\text{CM}} = 0.4\text{V}, V_{\text{S}}$ Ranges from 1.8V to 5V	● 80	95		dB
			74			dB
A_{V}	Large Signal Gain	$V_{\text{OUT}} = 0.5\text{V to } 1.3\text{V}, R_{\text{LOAD}} = 10\text{k}$	● 32	100		V/mV
			10			V/mV
		$V_{\text{OUT}} = 0.5\text{V to } 1.3\text{V}, R_{\text{LOAD}} = 1\text{k}$	● 15	35		V/mV
			4			V/mV
V_{OL}	Output Swing Low (Input Overdrive 30mV), Measured from V^-	No Load	●	35	50	mV
					100	mV
		$I_{\text{SINK}} = 100\mu\text{A}$	●	47	65	mV
					100	mV
		$I_{\text{SINK}} = 1\text{mA}$	●	100	150	mV
					180	mV

LTC6261/LTC6262/LTC6263

1.8V ELECTRICAL CHARACTERISTICS

The ● denotes the specifications which apply over the full operating temperature range, otherwise specifications are at $T_A = 25^\circ\text{C}$. $V_{\text{SUPPLY}} = 1.8\text{V}$, $V_{\text{CM}} = V_{\text{OUT}} = 0.4\text{V}$, $C_L = 10\text{pF}$, V_{SHDN} is unconnected.

SYMBOL	PARAMETER	CONDITIONS	MIN	TYP	MAX	UNITS
V_{OH}	Output Swing High (Input Overdrive 30mV), Measured from V^+	No Load	●	45	75 100	mV mV
		$I_{\text{SOURCE}} = 100\mu\text{A}$	●	50	75 100	mV mV
		$I_{\text{SOURCE}} = 1\text{mA}$	●	80	150 170	mV mV
I_{SC}	Output Short-Circuit Current		●	10 4	20	mA mA
I_{S}	Supply Current per Amplifier		●	215 150	240 300	μA μA
	Supply Current in Shutdown		●	1.5	2.5 4	μA μA
I_{SHDN}	Shutdown Pin Current	$V_{\text{SHDN}} = 0.5\text{V}$	●	10	80	nA
		$V_{\text{SHDN}} = 1.3\text{V}$	●	-10	0 10	nA
V_{IL}	SHDN Input Low Voltage	Disable	●		0.6	V
V_{IH}	SHDN Input High Voltage	Enable	●	1.3		V
t_{ON}	Turn-On Time	SHDN Toggle From 0V to 1.8V		20		μs
t_{OFF}	Turn-Off Time	SHDN Toggle From 1.8V to 0V		12		μs
GBW	Gain-Bandwidth Product	$f = 200\text{kHz}$	●	20 15	28	MHz MHz
T_{S}	Settling Time, 0.3V to 1.5V, Unity Gain	0.1%		0.2		μs
		0.01%		0.3		μs
SR	Slew Rate	$A_V = -1$, $V_{\text{OUT}} = 0.3\text{V}$ to 1.5V , $C_{\text{LOAD}} = 10\text{pF}$ $R_{\text{F}} = R_{\text{G}} = 10\text{k}\Omega$		6.5		V/ μs
FPBW	Full Power Bandwidth (Note 8)	$1.2V_{\text{P-P}}$		1725		kHz
THD+N	Total Harmonic Distortion and Noise	$f = 1\text{kHz}$, $A_V = 2$, $R_{\text{L}} = 4\text{k}\Omega$, $V_{\text{OUTP-P}} = 1\text{V}$ $V_{\text{IN}} = 0.65\text{V}$ to 1.15V		0.025 76		% dB

Note 1: Stresses beyond those listed under Absolute Maximum Ratings may cause permanent damage to the device. Exposure to any Absolute Maximum Rating condition for extended periods may affect device reliability and lifetime.

Note 2: The inputs are protected by back-to-back diodes as well as ESD protection diodes to each power supply. If the differential input voltage exceeds 3.6V or the input extends more than 500mV beyond the power supply, the input current should be limited to less than 10mA.

Note 3: A heat sink may be required to keep the junction temperature below the absolute maximum rating when the output is shorted indefinitely.

Note 4: LTC6261/LTC6262/LTC6263 are guaranteed functional over the temperature range of -40°C to 125°C . The LTC6261H/LTC6262H/LTC6263H are guaranteed functional over the temperature range of -40°C to 125°C .

Note 5: The LTC6261/LTC6262/LTC6263 are guaranteed to meet specified performance from -40°C to 85°C . The LTC6261H/LTC6262H/LTC6263H are guaranteed to meet specified performance from -40°C to 125°C .

Note 6: Thermal resistance varies with the amount of PC board metal connected to the package. The specified values are for short traces connected to the leads.

Note 7: The input bias current is the average of the currents through the positive and negative input pins.

Note 8: Full power bandwidth is calculated from the slew rate $\text{FPBW} = \text{SR}/\pi \cdot V_{\text{P-P}}$.

TYPICAL PERFORMANCE CHARACTERISTICS

Input V_{OS} Histogram

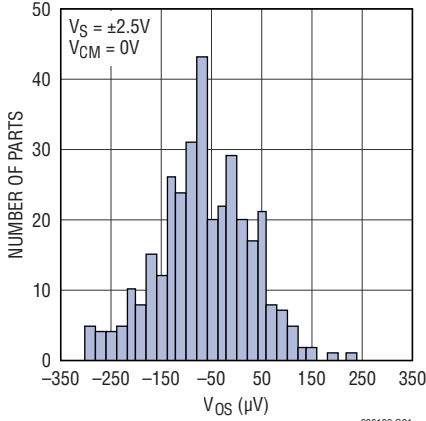

Input V_{OS} Histogram

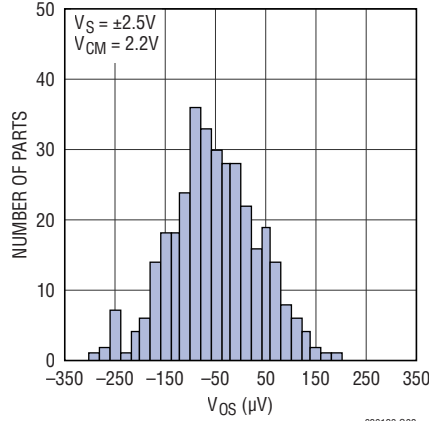

V_{OS} vs Temperature

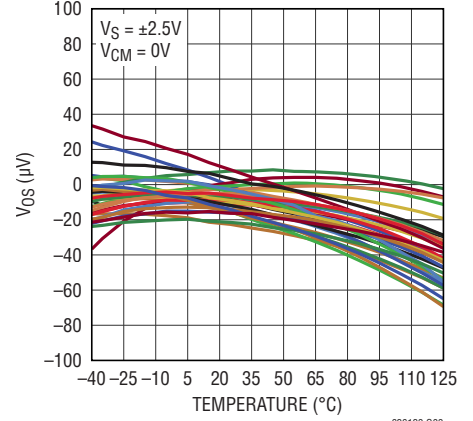

$V_{OS} T_C$ (-40°C to 125°C)

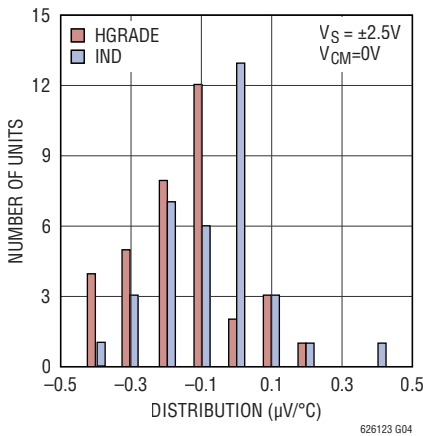

V_{OS} vs Supply Voltage (25°C)

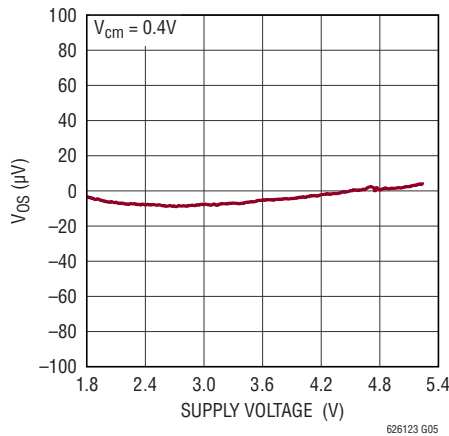

V_{OS} vs Common Mode Voltage

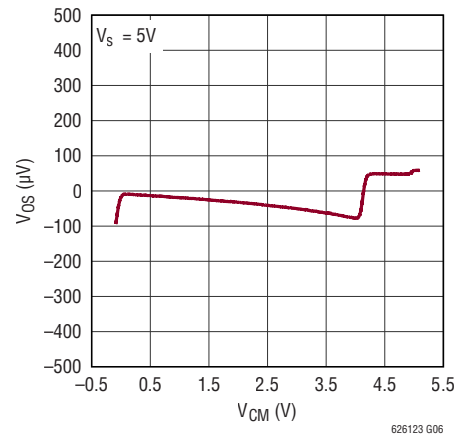

V_{OS} vs I_{OUT}

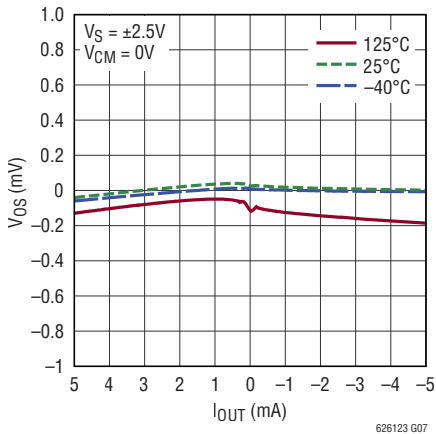

Input Bias Current vs Common Mode Voltage

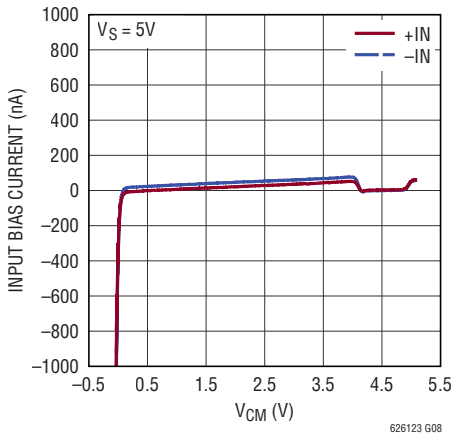

Input Bias Current vs Common Mode Voltage

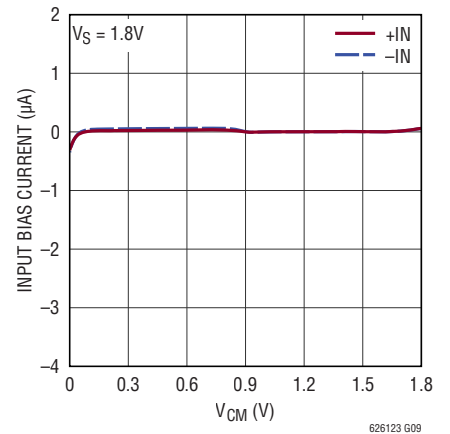

LTC6261/LTC6262/LTC6263

TYPICAL PERFORMANCE CHARACTERISTICS

Input Bias Current vs Supply Voltage

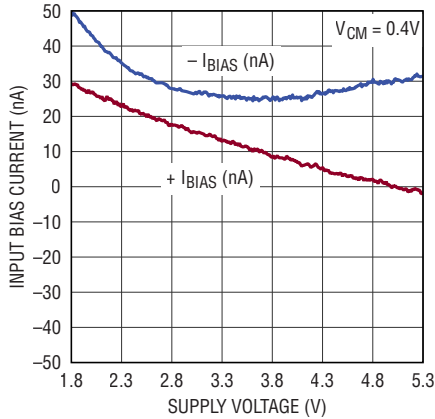

Input Bias Current vs Temperature

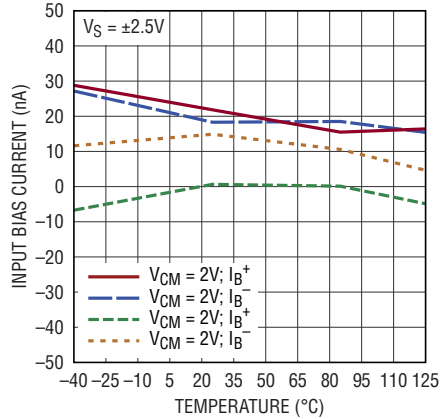

Supply Current vs Supply Voltage per Channel

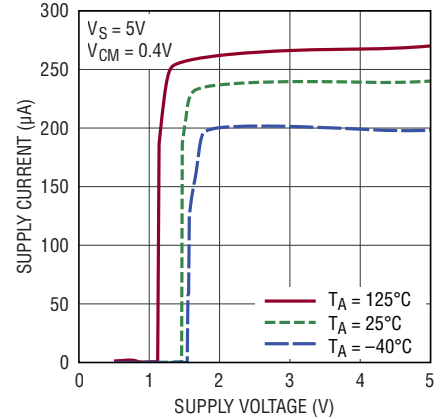

Supply Current vs Temperature

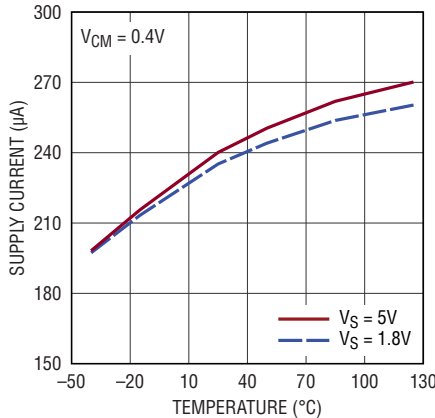

Output Saturation Voltage vs Load Current (Output High)

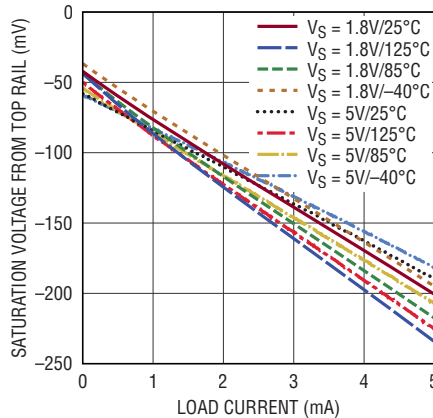

Output Saturation Voltage vs Load Current (Output Low)

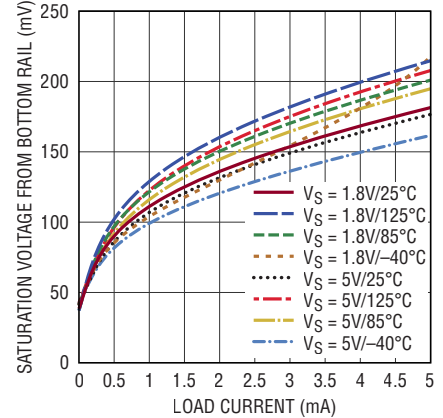

Output Short-Circuit Current vs Supply Voltage (Sourcing)

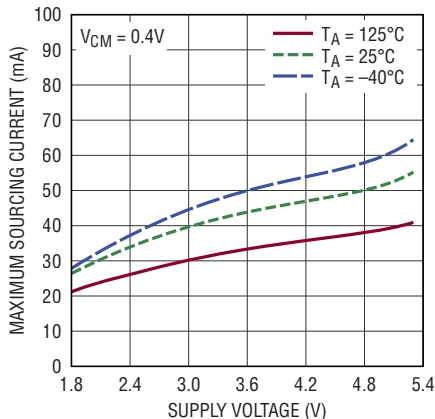

Output Short-Circuit Current vs Supply Voltage (Sinking)

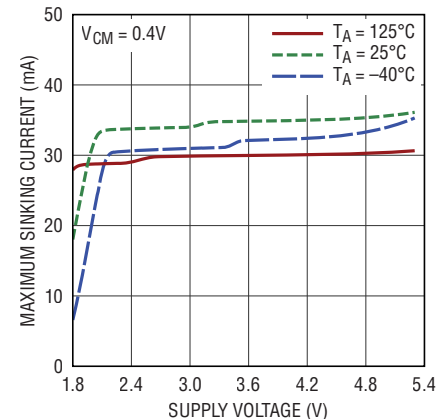

0.1Hz to 10Hz Output Voltage Noise

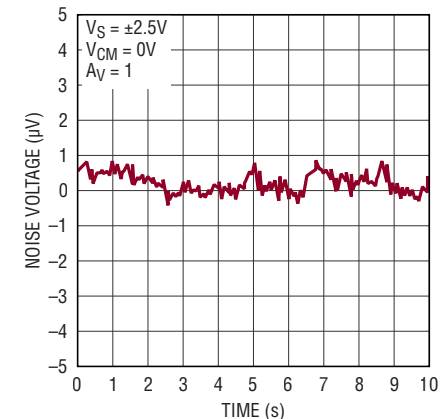

TYPICAL PERFORMANCE CHARACTERISTICS

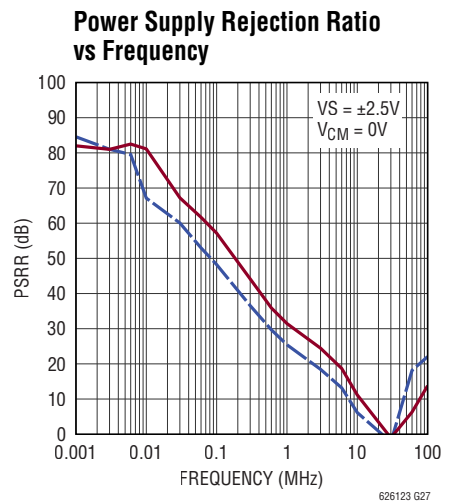
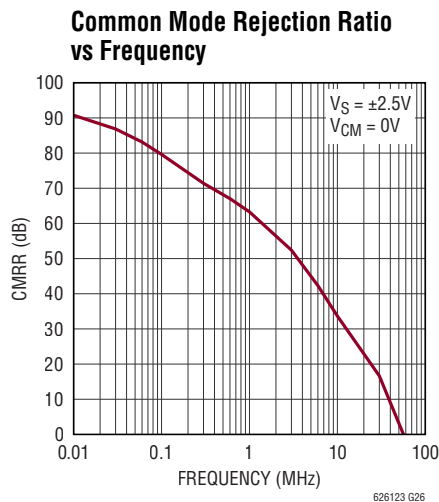
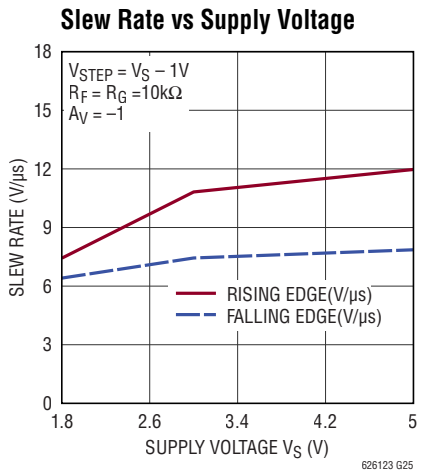
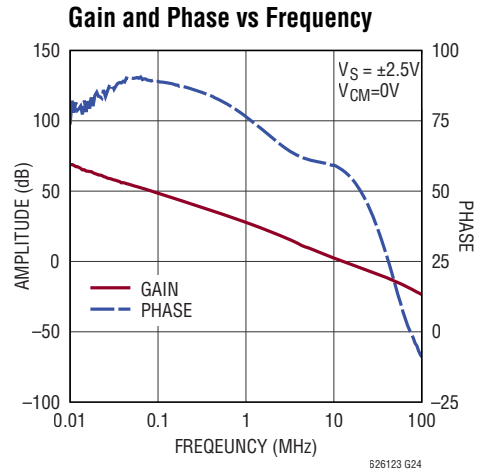
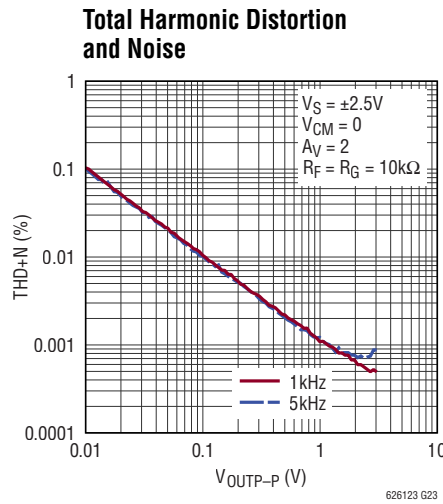
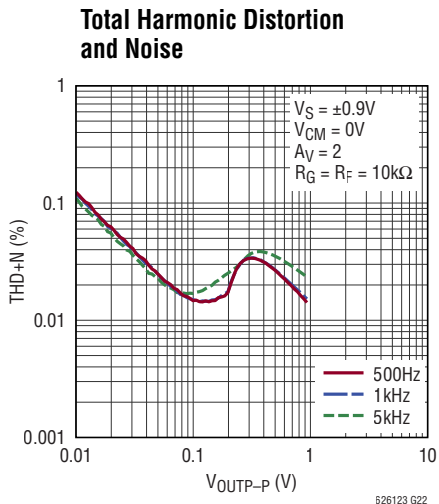
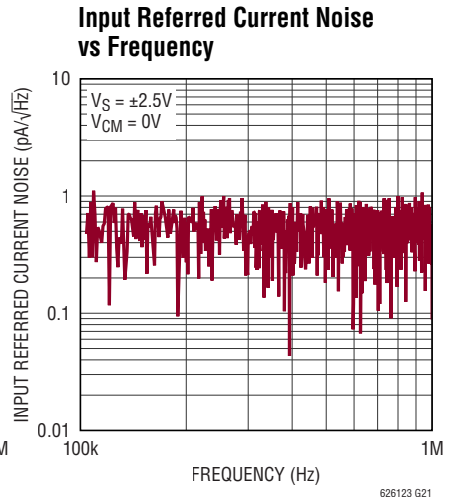
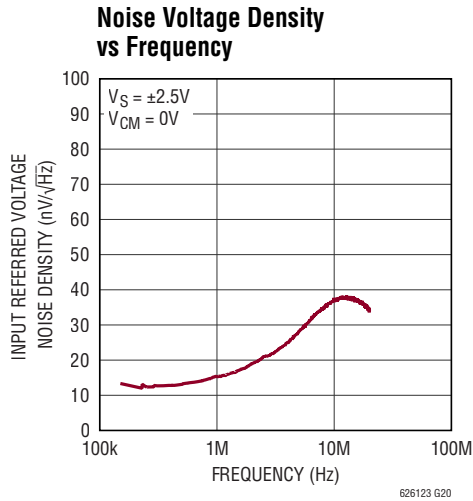
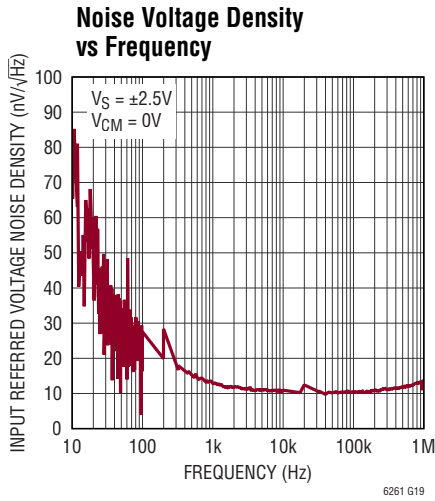

TYPICAL PERFORMANCE CHARACTERISTICS

Capacitive Load Handling Overshoot vs Capacitive Load

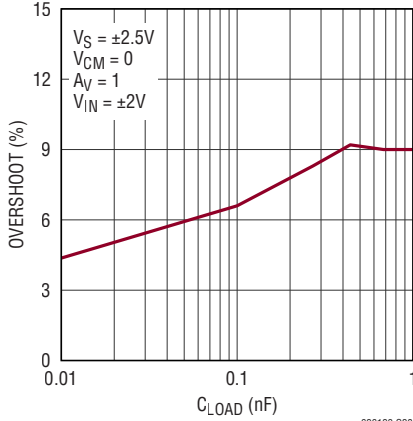

626123 G28

Large Signal Response

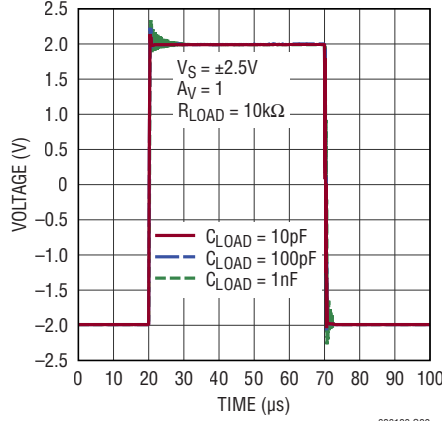

626123 G29

Small Signal Response

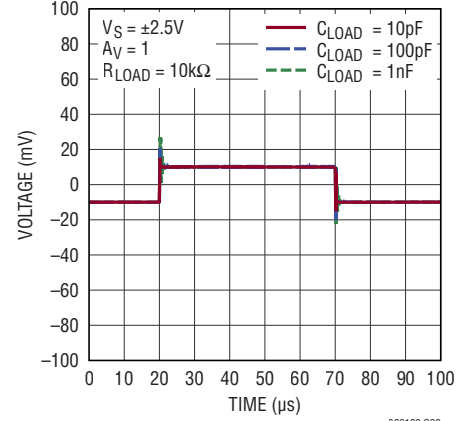

626123 G30

Large Signal Response

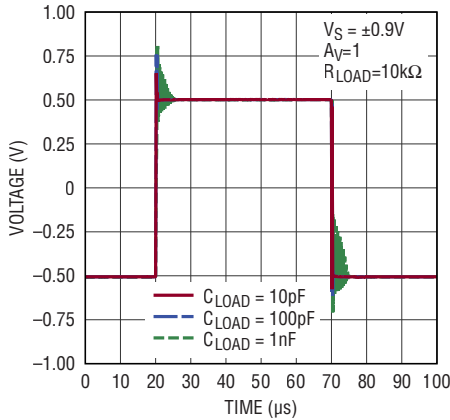

6262 G31

Small Signal Response

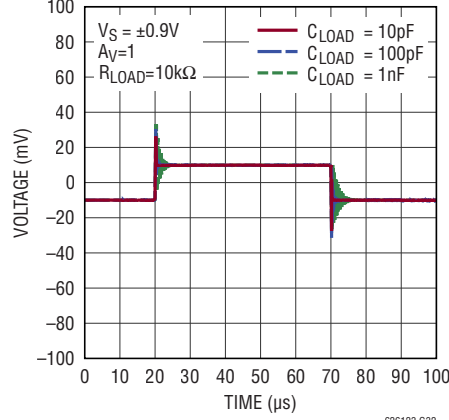

626123 G32

Output Impedance vs Frequency

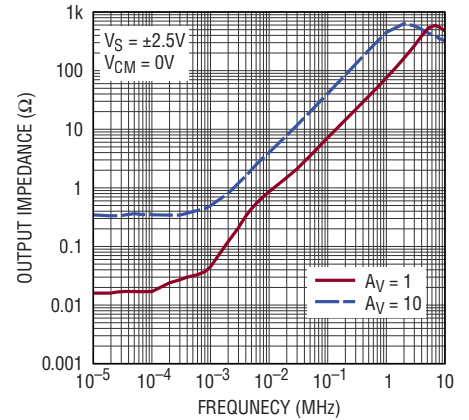

626123 G33

Supply Current vs SHDN Pin Voltage

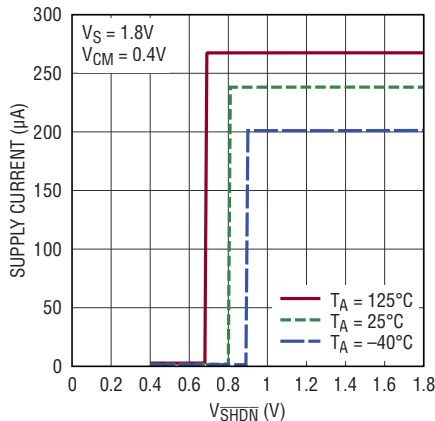

626123 G34

Supply Current vs SHDN Pin Voltage

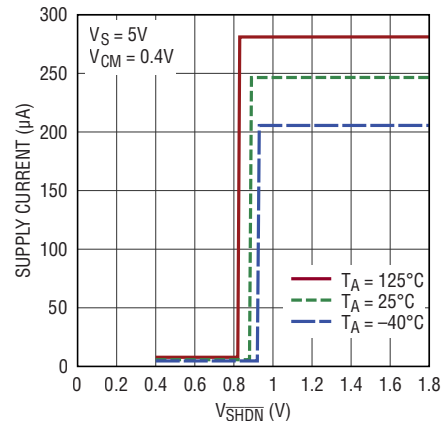

626123 G35

PIN FUNCTIONS

-IN: Inverting Input of the Amplifier. Voltage range of this pin can go from $V^- - 0.1V$ to $V^+ + 0.1V$.

+IN: Non-Inverting Input of Amplifier. This pin has the same voltage range as -IN.

V⁺: Positive Power Supply. Typically the voltage range spans from 1.8V to 5.25V. Split supplies are possible as long as the voltage between V^+ and V^- is between 1.8V and 5.25V. A bypass capacitor of 0.1 μ F as close to the part as possible should be used between power supply pins in single supply applications or between supply pins and ground in split supply applications.

V⁻: Negative Power Supply. It is normally tied to ground. It can also be tied to a voltage other than ground as long as the voltage between V^+ and V^- is from 1.8V to 5.25V. If it is not connected to ground, bypass it with a capacitor of 0.1 μ F as close to the part as possible.

SHDN: Active Low Shutdown. Shutdown threshold is 0.6V above negative rail. If left unconnected, the amplifier will be on.

OUT: Amplifier Output. Rail-to-rail amplifier output capable of delivering greater than $\pm 10mA$

SIMPLIFIED SCHEMATIC

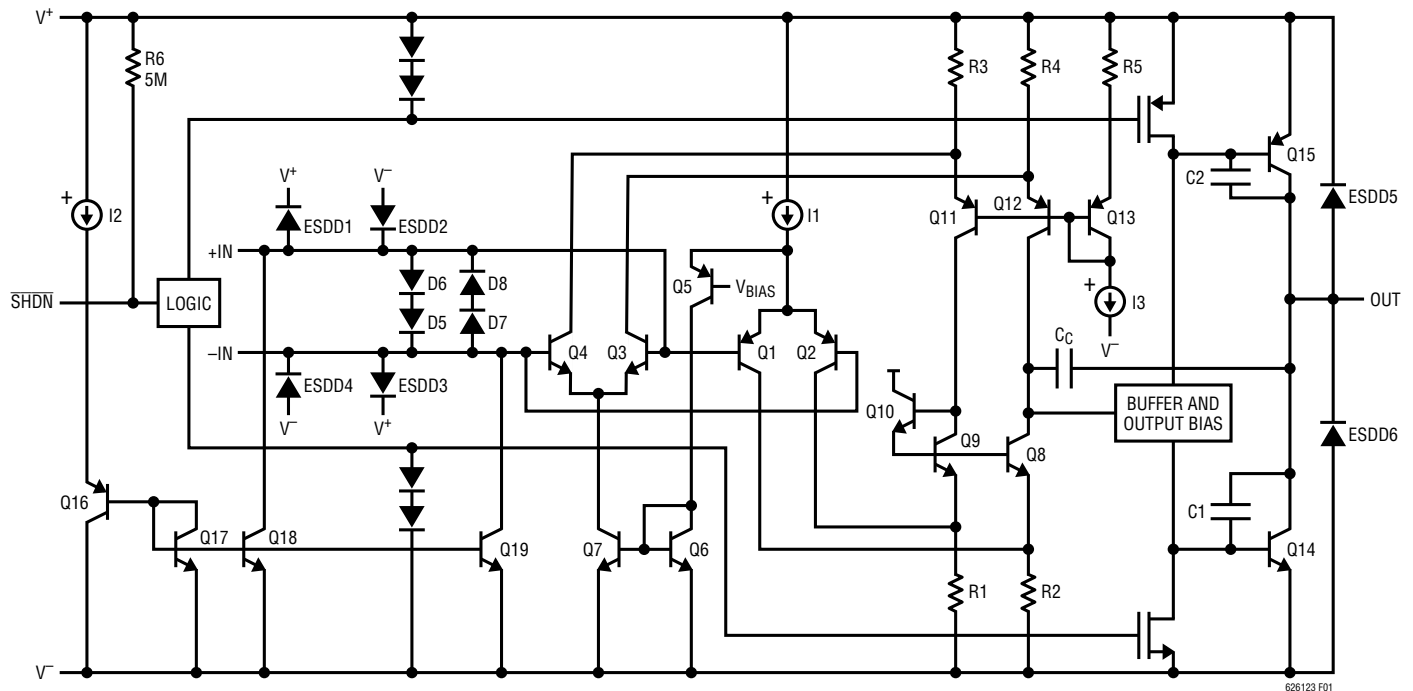

Figure 1. LTC6261/LTC6262/LTC6263 Simplified Schematic

OPERATION

The LTC6261 family input signal range extends slightly beyond the negative and positive power supplies. The output can even extend all the way to the negative supply with the proper external pull-down current source. Figure 1 depicts a Simplified Schematic of the amplifier. The input stage is comprised of two differential amplifiers, a PNP stage Q1/Q2 and NPN stage Q3/Q4 that are active over different ranges of common mode input voltage. The PNP stage is active between the negative power supply to approximately 1V below the positive supply. As the input voltage approaches the positive supply, transistor Q5 will steer the tail current I1 to the current mirror Q6/Q7, activating the NPN differential pair and the PNP pair

becomes inactive for the remaining input common mode range. Also for the input stage, devices Q17, Q18 and Q19 act to cancel the bias current of the PNP input pair. When Q1/Q2 is active, the current in Q16 is controlled to be the same as the current Q1/Q2. Thus, the base current of Q16 is normally equal to the base current of the input devices of Q1/Q2. Similar circuitry (not shown) is used to cancel the base current of Q3/Q4. The buffer and output bias stage uses a special compensation technique to take full advantage of the process technology to drive high capacitive loads. The common emitter topology of Q14/Q15 enables the output to swing from rail-to-rail.

APPLICATIONS INFORMATION

Low Supply Voltage and Low Power Consumption

The LTC6261 family of operational amplifiers can operate with power supply voltages from 1.8V to 5.25V. Each amplifier draws 240 μ A. The low supply voltage capability and low supply current are ideal for portable applications.

High Capacitive Load Driving Capability and Wide Bandwidth

The LTC6261 family is optimized for wide bandwidth and low power applications. They have an extremely high gain-bandwidth to power ratio and are unity gain stable (see Typical Performance Characteristics, Capacitive Load Handling). Higher gain configurations tend to have better capacitive drive capability than lower gain configurations due to lower closed loop bandwidth and hence higher phase margin.

Low Input Referred Noise

The LTC6261 family provides a low input referred noise of 13nV/ $\sqrt{\text{Hz}}$ at 10kHz. The average noise voltage density over 1MHz of bandwidth is less than 15nV/ $\sqrt{\text{Hz}}$. The LTC6261 family is ideal for low noise and low power signal processing applications.

Low Input Offset Voltage

The LTC6261 family has a low offset voltage of 1mV maximum. The offset voltage is trimmed with a proprietary algorithm to ensure low offset voltage over the entire common mode voltage range.

Low Input Bias Current

The LTC6261 family uses a bias current cancellation circuit to compensate for the base current of the input transistors. When the input common mode voltage is within 200mV of either rail, the bias cancellation circuit is no longer active. For common mode voltages ranging from 0.2V above the negative supply to 0.2V below the positive supply, the low input bias current allows the amplifiers to be used in applications with high resistance sources.

Ground Sensing and Rail-to-Rail Output

The LTC6261 family has excellent output drive capability, delivering over 10mA of output drive current. The output stage is a rail-to-rail topology that is capable of swinging to within 250mV of either rail. If output swing to the negative rail is required, an external pull down resistor to a negative supply can be added. For 5V/0V op amp supplies, a pull

APPLICATIONS INFORMATION

down resistor of 1k to $-2V$ will allow a ‘true zero’ output swing. In this case, the output can swing all the way to the bottom rail while maintaining 50dB of open loop gain. Since the inputs can go 100mV beyond either rail, the op amp can easily perform ‘true ground’ sensing.

The maximum output current is a function of total supply voltage. As the supply voltage to the amplifier increases, the output current capability also increases. Attention must be paid to keep the junction temperature of the IC below 150°C when the output is in continuous short-circuit. The output of the amplifier has reverse-biased diodes connected to each supply. The output should not be forced more than 0.5V beyond either supply; otherwise current will flow through these diodes.

Input Protection and Output Overdrive

To prevent breakdown of the input transistors, the input stages are protected against a large differential input voltage by two pairs of back-to-back diodes, D5 to D8. If the differential input voltage exceeds 1.4V, the current in these diodes must be limited to less than 10mA. These amplifiers are not intended for open loop applications such as comparators. When the output stage is overdriven, internal limiting circuitry is activated to improve overdrive recovery. In some applications, this circuitry may draw as much as 1mA supply current.

ESD

The LTC6261 family has reverse-biased ESD protection diodes on all inputs and output as shown in Figure 1.

Supply Voltage Ramping

Fast ramping of the supply voltage can cause a current glitch in the internal ESD protection circuits. Depending on the supply inductance, this could result in a supply voltage transient that exceeds the maximum rating. A supply voltage ramp time of greater than 1ms is recommended.

Feedback Components

Care must be taken to ensure that the pole formed by the feedback resistors and the parasitic capacitance at the inverting input does not degrade stability. For example, in a gain of +2 configuration with gain and feedback resistors of 10k, a poorly designed circuit board layout with parasitic capacitance of 5pF (part +PC board) at the amplifier’s inverting input will cause the amplifier to oscillate due to a pole formed at 3.2MHz. An additional capacitor of 4.7pF across the feedback resistor as shown in Figure 2 will eliminate any ringing or oscillation.

Shutdown

The single and dual versions have $\overline{\text{SHDN}}$ pins that can shut down the amplifier to less than $10\mu\text{A}$ supply current. The $\overline{\text{SHDN}}$ pin voltage needs to be within 0.6V of V^- for the amplifier to shut down. During shutdown, the output is in high impedance state. When left floating, the $\overline{\text{SHDN}}$ pin is internally pulled up to the positive supply and the amplifier remains enabled.

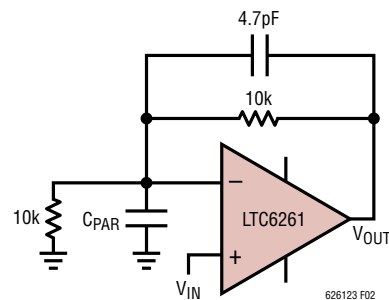

Figure 2.

TYPICAL APPLICATIONS

DRIVING A SAR

The circuit next uses a traditional noninverting gain configuration to map a ground referenced input voltage signal to the full scale of a 500kS/s, 12 bit LTC2362 ADC. This application takes advantage of the LTC6261 family's combination of excellent common mode rejection, bandwidth, supply current, and noise to enable high performance ADC at low dissipation. The high bandwidth and open loop gain combine to provide good distortion performance given the low supply current usage. The capacitor CF1 can be used as needed to improve phase margin if there is any peaking in the closed loop response due to total capacitance seen at the input terminals of the op amp as mounted on a PCB. The resistors should be chosen to minimize adding excessive noise while at the same time minimizing total current consumption and avoiding distortion due to overloading the amplifier. The choice of resistor, then, will be commensurate with the input noise voltage and noise current of the LTC6261. Use of an output filter is critical in reducing noise and spurious high frequency content that might alias.

SAR ADC Driver

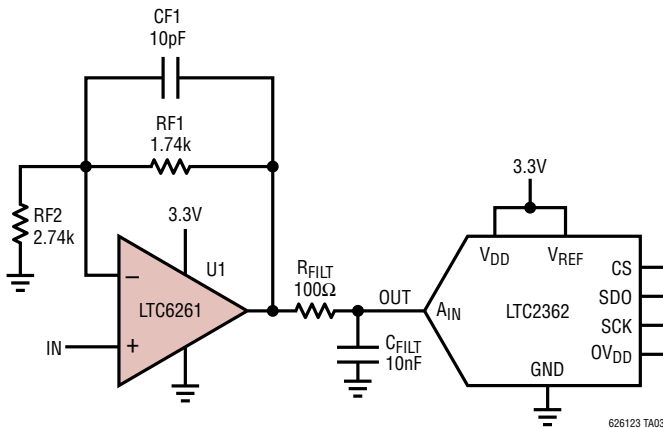

Current consumption of the op amp circuit is 560μA at 3.3V supply with the output centered at 1.65V. Increasing the resistors with the same scaling factor will lower the total consumption at the expense of more resistor noise.

LTC6261 Driving LTC2362 ADC

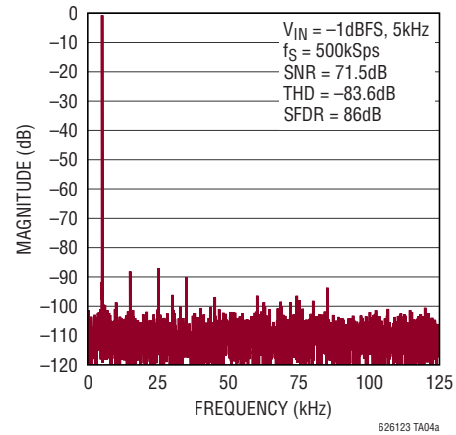

LTC6261 Driving LTC2362 ADC

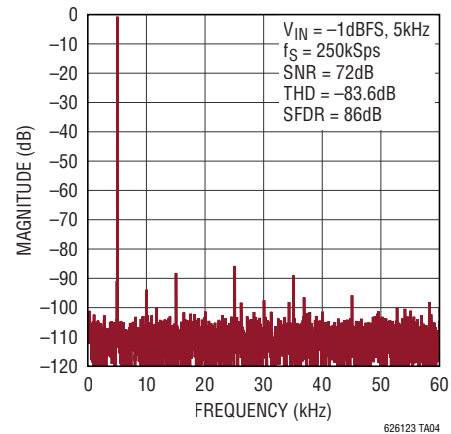

Results are shown with a 12 bit LTC2362 SAR ADC running at both 500k Samples and 250k Samples. In both cases, the ENOB is about 11.5.

ACTIVE FILTERS

Second Order Bessel Filter

Ample bandwidth and low supply current allows deployment of active filters in portable and other low power applications. The second order Bessel filter provides a traditionally clean transient response.

TYPICAL APPLICATIONS

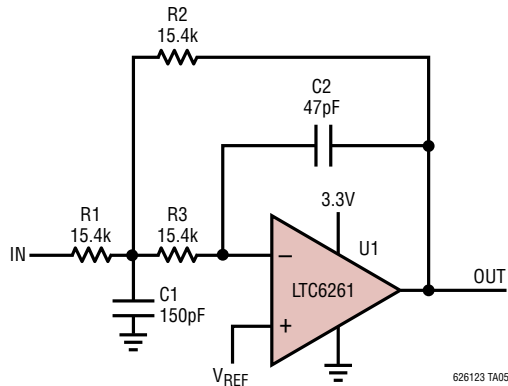

Supply current consumption is around 230 μ A. The values of resistors chosen minimize consumption at the expense of noise.

LTC6261 Second Order Butterworth Frequency Response

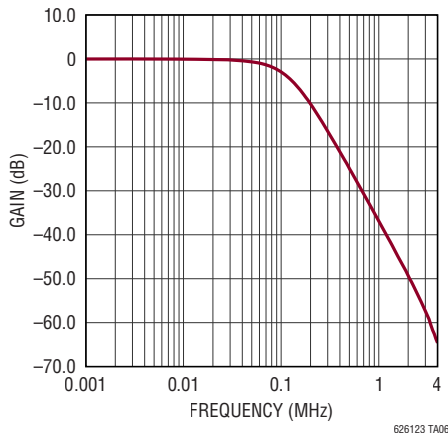

Bessel Filter Response

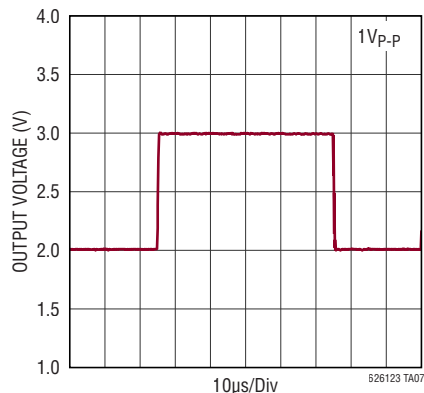

The frequency response shows an expected roll-off of two poles along with a gentle droop near the 3dB point; the transient response is very clean.

Third Order Butterworth Filter

Maximally flat magnitude response in the pass-band arises from use of a Butterworth filter. A third R-C stage is added in front of the filter in order to maximize the roll-off for a single amplifier circuit.

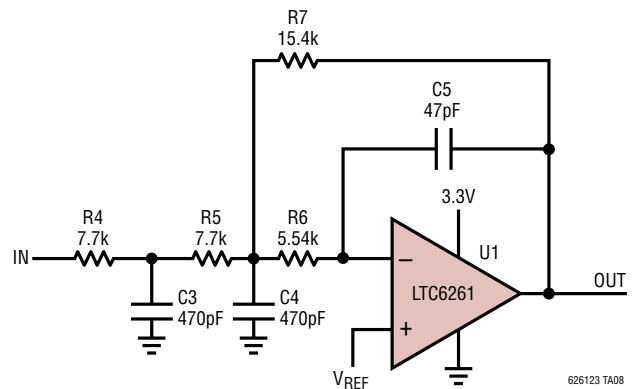

Supply current consumption is around 235 μ A. The values of resistors chosen minimize consumption at the expense of noise.

LTC6261 Third Order Butterworth Frequency Response

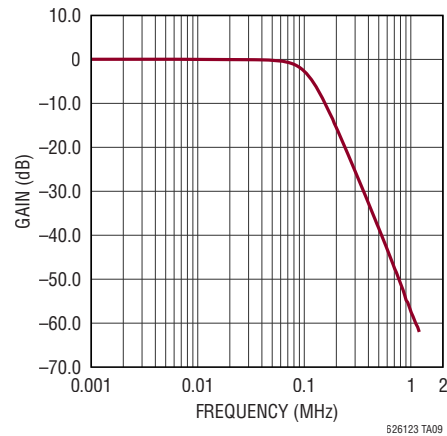

TYPICAL APPLICATIONS

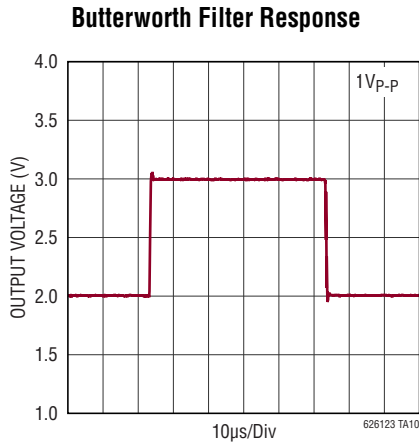

The frequency response shows an expected roll-off of three poles, an extended plateau, and a sharp roll-off; the transient response includes a small amount of ringing.

BRIDGE-TIED DIFFERENTIAL OUTPUT AMPLIFIER

The low supply current at the bandwidth and noise performance allows for excellent fidelity at a fraction of the usual dissipation in portable audio equipment.

Headphone speaker impedances range from 32Ω to 300Ω ; their responsivity, from 80dB to 100dB SPL per 1mW and beyond. As an example, considering a headphone speaker with 90dB SPL per 1mW, it takes 100mW to reach 110dB SPL. With 32Ω , the RMS current is 56mA and voltage 1.8V; with 120Ω , 29mA and 3.5V.

Given a 3.3V supply and the output of one LTC6261 amplifier there may not be sufficient drive capability to yield 100mW. However, the combination of two 180 degree phased amplifiers is enough to provide the necessary drive voltage or current to reach upwards of 100mW. Duplication of this bridge drive circuit enables power to both left and right sides.

The LTC6263 provides four amplifiers in one small package. Data from a two-amplifier LTC6262 driving what could be Left or Right is shown below. Basic current consumption of the two amplifiers, with as much as $1V_{P-P}$ input but no load, is $500\mu A$.

Audio Headphones Bridge Driver

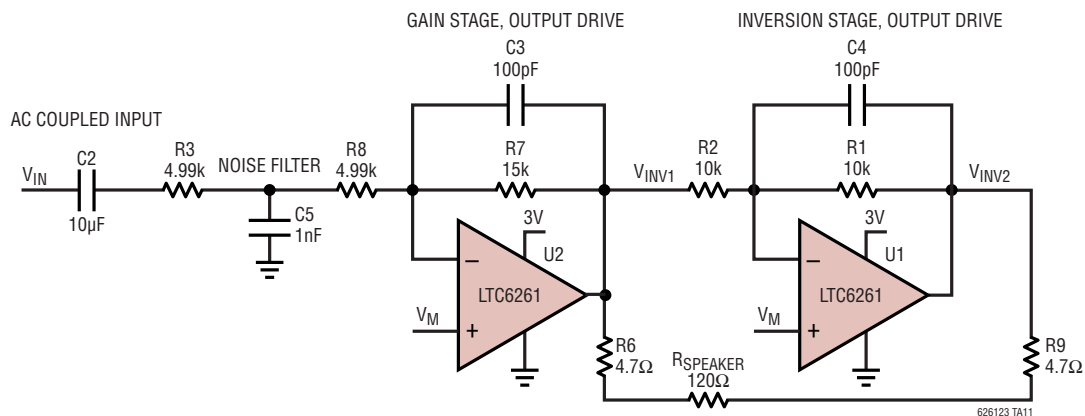

TYPICAL APPLICATIONS

The circuit consists of first an inverting gain stage with closed loop gain = 3, and a subsequent inverting stage. The combination of inverting stages produces a single-ended input to differential output gain of 6. With 1V_{P-P} single-ended input, the output is 6V_{P-P} differential, or 3V max (2.1V RMS). With 100Ω, 1V leads to 45mW delivered power.

Despite the low quiescent current, this driver delivers low distortion to a headphone load. At high enough amplitude, distortion increases dramatically as the op amp output clips. Clipping occurs sooner with more loading as the output transistors start to run out of current gain.

LTC6262 Bridge Driver THD and Noise with Different Loads vs Frequency

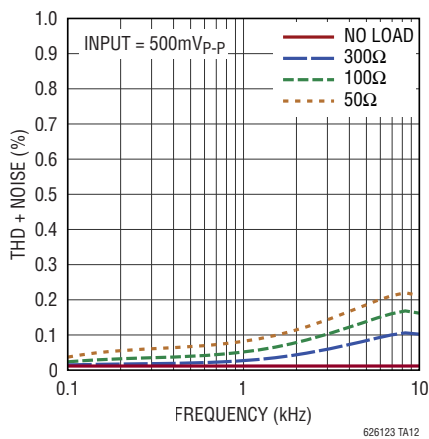

LTC6262 Bridge Driver THD and Noise with Different Loads vs Amplitude at 1kHz

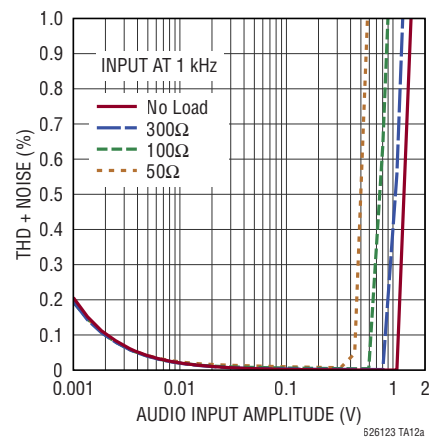

PACKAGE DESCRIPTION

Please refer to <http://www.linear.com/product/LTC6261#packaging> for the most recent package drawings.

S6 Package 6-Lead Plastic TSOT-23 (Reference LTC DWG # 05-08-1636)

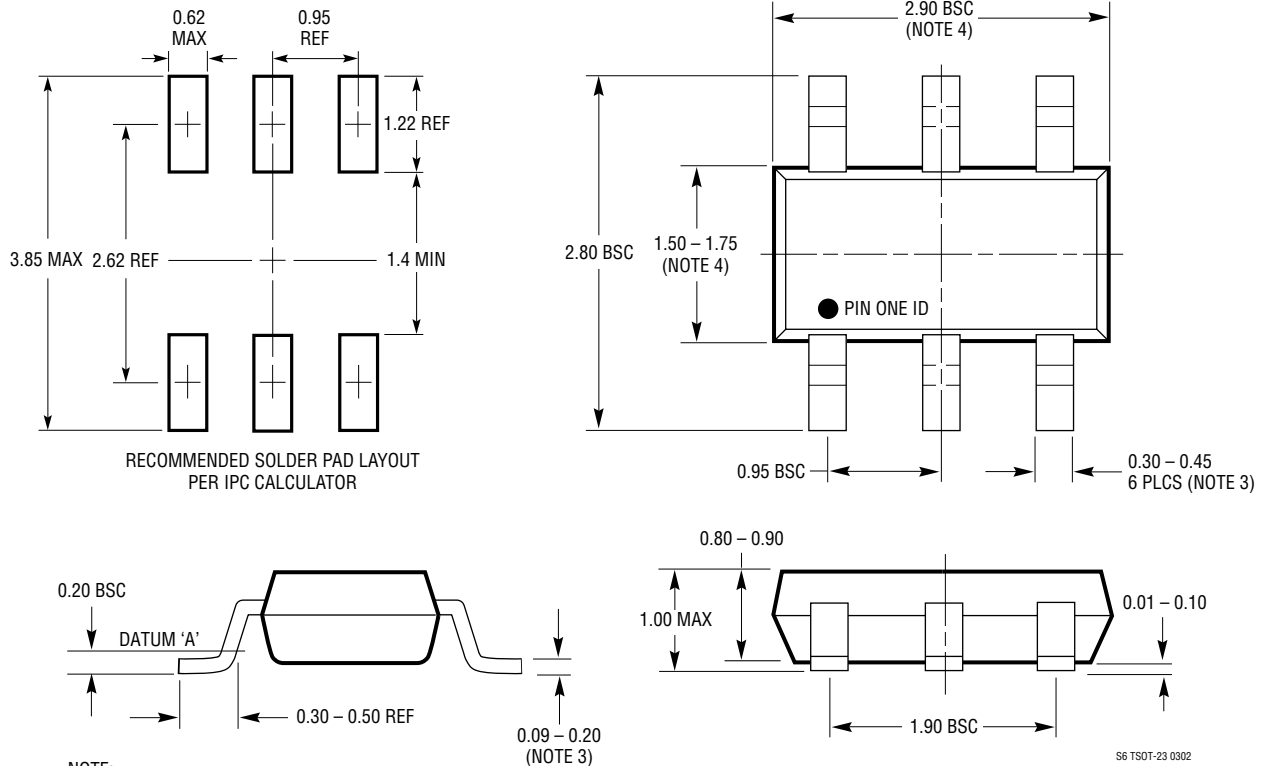

- NOTE:
1. DIMENSIONS ARE IN MILLIMETERS
 2. DRAWING NOT TO SCALE
 3. DIMENSIONS ARE INCLUSIVE OF PLATING
 4. DIMENSIONS ARE EXCLUSIVE OF MOLD FLASH AND METAL BURR
 5. MOLD FLASH SHALL NOT EXCEED 0.254mm
 6. JEDEC PACKAGE REFERENCE IS MO-193

S6 TSOT-23 0302

PACKAGE DESCRIPTION

Please refer to <http://www.linear.com/product/LTC6262#packaging> for the most recent package drawings.

DC6 Package
6-Lead Plastic DFN (2mm × 2mm)
 (Reference LTC DWG # 05-08-1703 Rev C)

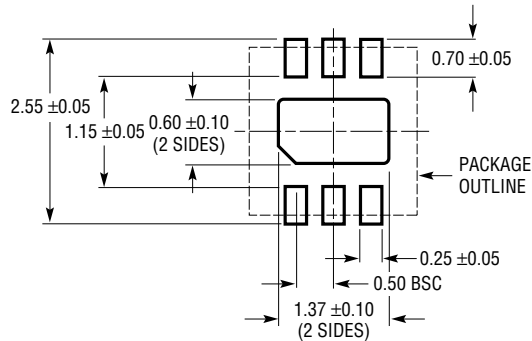

RECOMMENDED SOLDER PAD PITCH AND DIMENSIONS

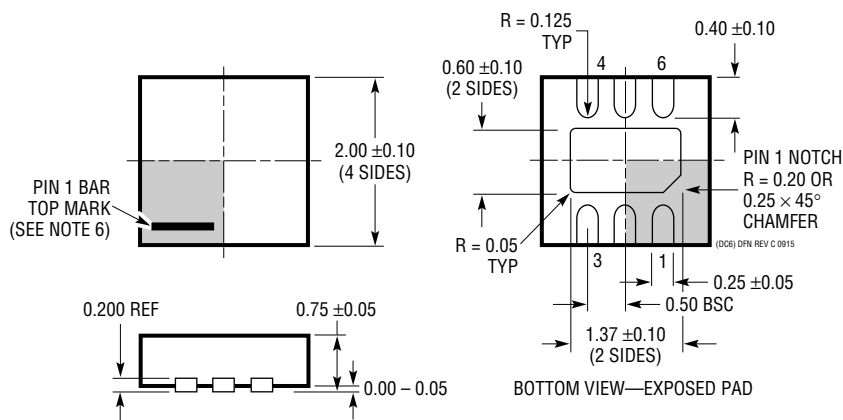

NOTE:

1. DRAWING TO BE MADE A JEDEC PACKAGE OUTLINE M0-229 VARIATION OF (WCCD-2)
2. DRAWING NOT TO SCALE
3. ALL DIMENSIONS ARE IN MILLIMETERS
4. DIMENSIONS OF EXPOSED PAD ON BOTTOM OF PACKAGE DO NOT INCLUDE MOLD FLASH. MOLD FLASH, IF PRESENT, SHALL NOT EXCEED 0.15mm ON ANY SIDE
5. EXPOSED PAD SHALL BE SOLDER PLATED
6. SHADED AREA IS ONLY A REFERENCE FOR PIN 1 LOCATION ON THE TOP AND BOTTOM OF PACKAGE

PACKAGE DESCRIPTION

Please refer to <http://www.linear.com/product/LTC6261#packaging> for the most recent package drawings.

DC8 Package
8-Lead Plastic DFN (2mm × 2mm)
 (Reference LTC DWG # 05-08-1719 Rev A)

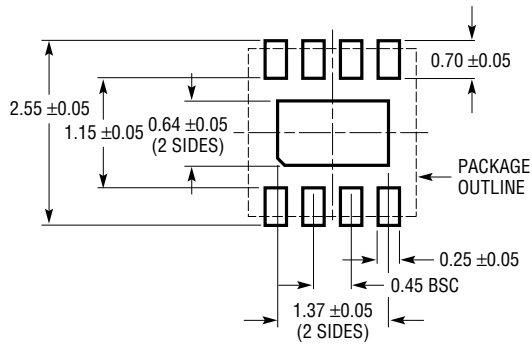

RECOMMENDED SOLDER PAD PITCH AND DIMENSIONS
 APPLY SOLDER MASK TO AREAS THAT ARE NOT SOLDERED

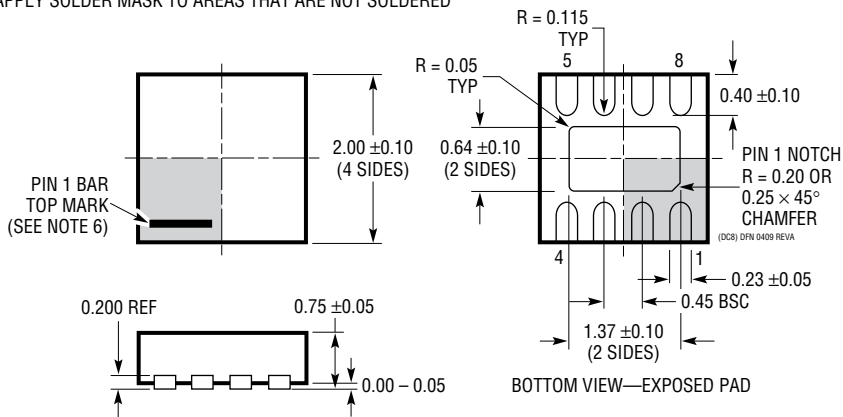

NOTE:

1. DRAWING IS NOT A JEDEC PACKAGE OUTLINE
2. DRAWING NOT TO SCALE
3. ALL DIMENSIONS ARE IN MILLIMETERS
4. DIMENSIONS OF EXPOSED PAD ON BOTTOM OF PACKAGE DO NOT INCLUDE MOLD FLASH. MOLD FLASH, IF PRESENT, SHALL NOT EXCEED 0.15mm ON ANY SIDE
5. EXPOSED PAD SHALL BE SOLDER PLATED
6. SHADED AREA IS ONLY A REFERENCE FOR PIN 1 LOCATION ON THE TOP AND BOTTOM OF PACKAGE

PACKAGE DESCRIPTION

Please refer to <http://www.linear.com/product/LTC6262#packaging> for the most recent package drawings.

TS8 Package
8-Lead Plastic TSOT-23
 (Reference LTC DWG # 05-08-1637 Rev A)

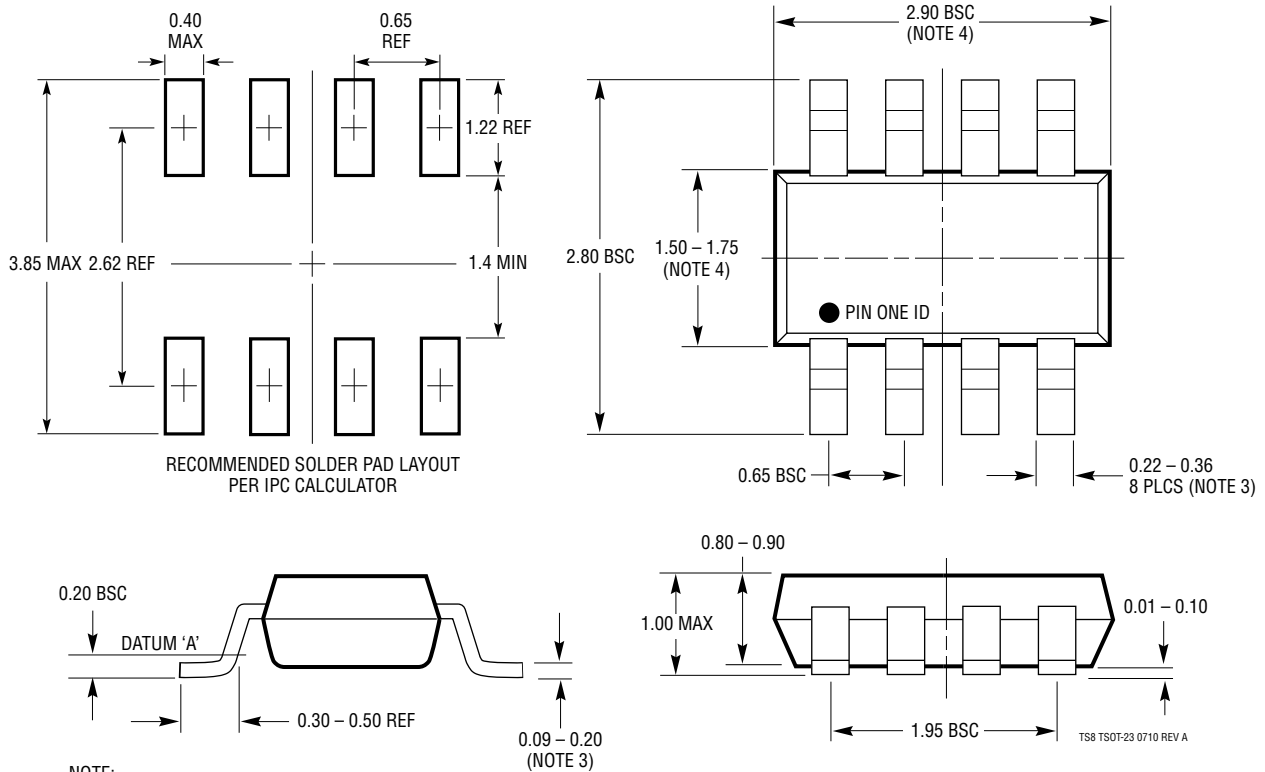

- NOTE:
1. DIMENSIONS ARE IN MILLIMETERS
 2. DRAWING NOT TO SCALE
 3. DIMENSIONS ARE INCLUSIVE OF PLATING
 4. DIMENSIONS ARE EXCLUSIVE OF MOLD FLASH AND METAL BURR
 5. MOLD FLASH SHALL NOT EXCEED 0.254mm
 6. JEDEC PACKAGE REFERENCE IS MO-193

PACKAGE DESCRIPTION

Please refer to <http://www.linear.com/product/LTC6262#packaging> for the most recent package drawings.

MS8 Package 8-Lead Plastic MSOP

(Reference LTC DWG # 05-08-1660 Rev G)

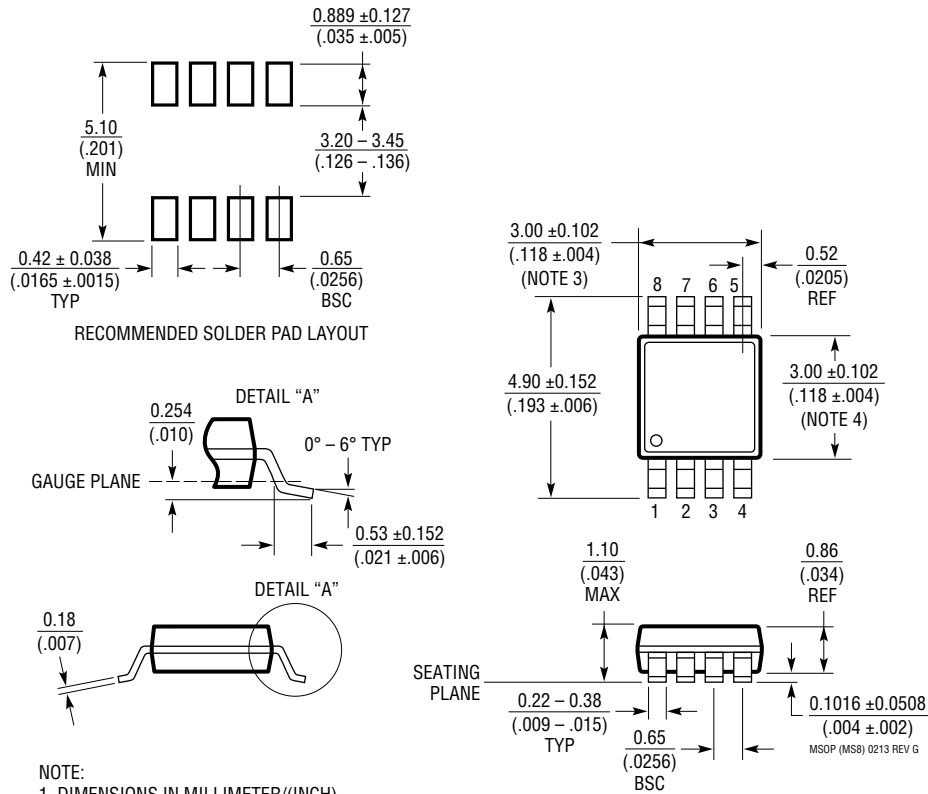

NOTE:

1. DIMENSIONS IN MILLIMETER/(INCH)
2. DRAWING NOT TO SCALE
3. DIMENSION DOES NOT INCLUDE MOLD FLASH, PROTRUSIONS OR GATE BURRS.
MOLD FLASH, PROTRUSIONS OR GATE BURRS SHALL NOT EXCEED 0.152mm (.006") PER SIDE
4. DIMENSION DOES NOT INCLUDE INTERLEAD FLASH OR PROTRUSIONS.
INTERLEAD FLASH OR PROTRUSIONS SHALL NOT EXCEED 0.152mm (.006") PER SIDE
5. LEAD COPLANARITY (BOTTOM OF LEADS AFTER FORMING) SHALL BE 0.102mm (.004") MAX

PACKAGE DESCRIPTION

Please refer to <http://www.linear.com/product/LTC6261#packaging> for the most recent package drawings.

MS Package 10-Lead Plastic MSOP

(Reference LTC DWG # 05-08-1661 Rev F)

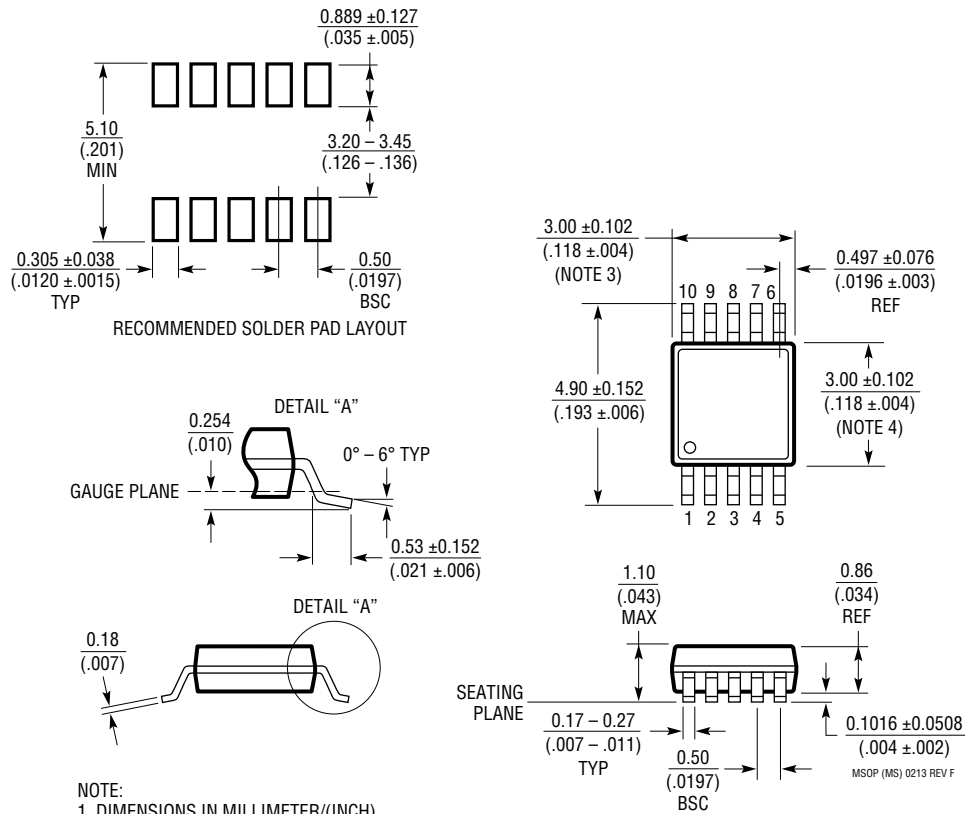

NOTE:

1. DIMENSIONS IN MILLIMETER/(INCH)
2. DRAWING NOT TO SCALE
3. DIMENSION DOES NOT INCLUDE MOLD FLASH, PROTRUSIONS OR GATE BURRS.
MOLD FLASH, PROTRUSIONS OR GATE BURRS SHALL NOT EXCEED 0.152mm (.006") PER SIDE
4. DIMENSION DOES NOT INCLUDE INTERLEAD FLASH OR PROTRUSIONS.
INTERLEAD FLASH OR PROTRUSIONS SHALL NOT EXCEED 0.152mm (.006") PER SIDE
5. LEAD COPLANARITY (BOTTOM OF LEADS AFTER FORMING) SHALL BE 0.102mm (.004") MAX

PACKAGE DESCRIPTION

Please refer to <http://www.linear.com/product/LTC6262#packaging> for the most recent package drawings.

MS Package 16-Lead Plastic MSOP (Reference LTC DWG # 05-08-1669 Rev A)

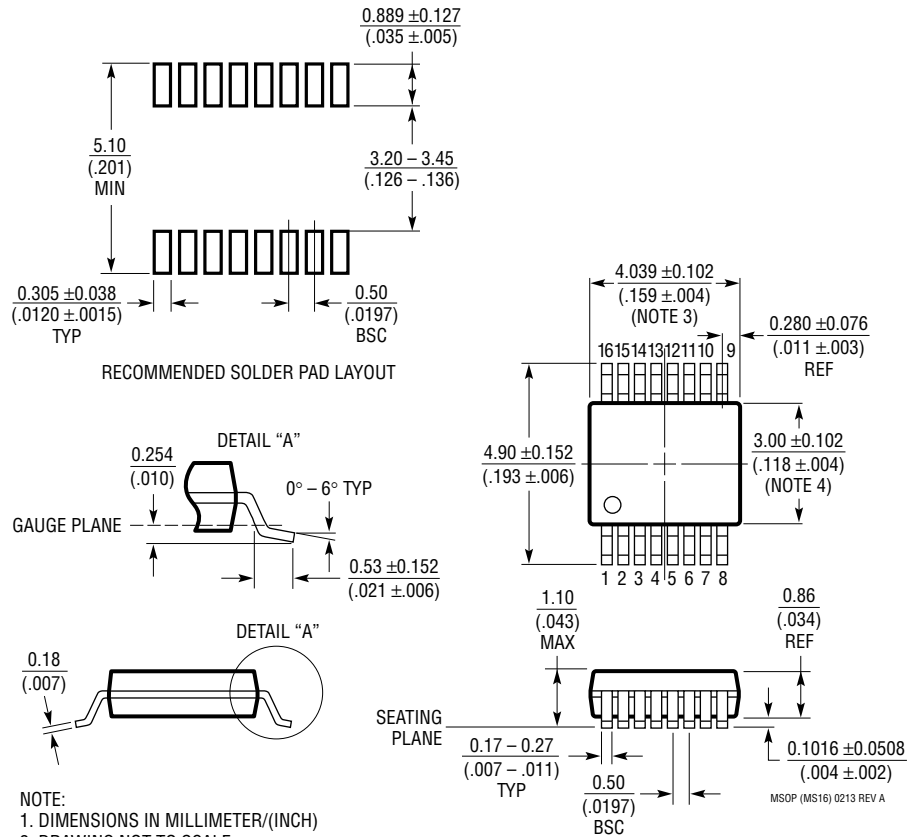

- NOTE:
1. DIMENSIONS IN MILLIMETER/(INCH)
 2. DRAWING NOT TO SCALE
 3. DIMENSION DOES NOT INCLUDE MOLD FLASH, PROTRUSIONS OR GATE BURRS.
MOLD FLASH, PROTRUSIONS OR GATE BURRS SHALL NOT EXCEED 0.152mm (.006") PER SIDE
 4. DIMENSION DOES NOT INCLUDE INTERLEAD FLASH OR PROTRUSIONS.
INTERLEAD FLASH OR PROTRUSIONS SHALL NOT EXCEED 0.152mm (.006") PER SIDE
 5. LEAD COPLANARITY (BOTTOM OF LEADS AFTER FORMING) SHALL BE 0.102mm (.004") MAX

MSOP (MS16) 0213 REV A

REVISION HISTORY

REV	DATE	DESCRIPTION	PAGE NUMBER
A	07/17	Added LTC6261 TSOT-23 6-lead package Corrected I_S value Corrected supply current in shutdown Corrected I_B	1 to 3, 18 4 1, 4, 13 5

TYPICAL APPLICATION

Bridge-Tied Differential Output Amplifier

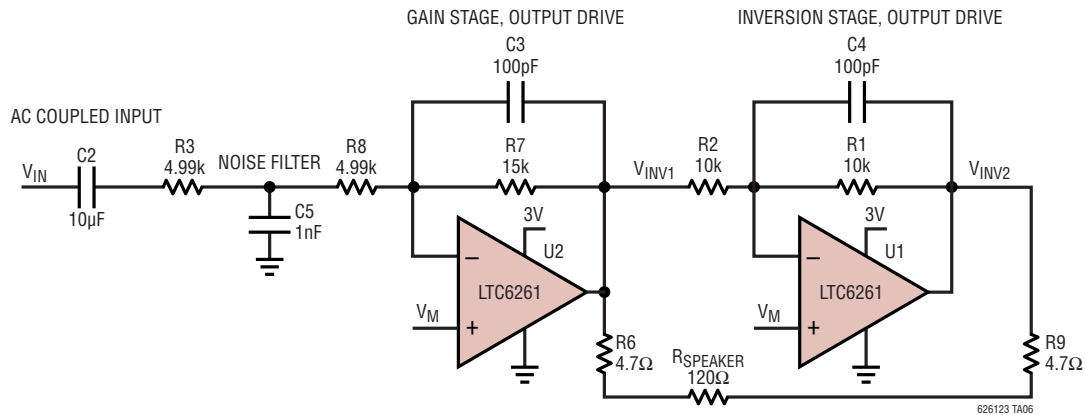

RELATED PARTS

PART NUMBER	DESCRIPTION	COMMENTS
LTC6255/LTC6256/LTC6257	6.5MHz, 65µA Power Efficient RR Op Amp	6.5MHz, 65µA, RR IN/OUT, 1.8V to 5.25V
LTC6246/LTC6247/LTC6248	180MHz, 1mA, Power Efficient Rail-to-Rail Op Amps	180MHz GBW, 1mA, 500µV V_{OS} , RR In/Out, 2.5V to 5.25V, 90V/µs Slew Rate
LT1498/LT1499	10MHz, 6V/µs, Dual/Quad, Rail-to-Rail Input and Output, Precision C-Load Op Amps	10MHz GBW, 1.7mA, 475µV V_{OS} , RR In/Out, 2.2V to ±15V, 10nF C_{LOAD}
LTC6081/LTC6082	Precision Dual/Quad CMOS Rail-to-Rail Input/Output Amplifiers	3.6MHz GBW, 330µA, 70µV V_{OS} , RR In/Out, 2.7V to 5.5V, 100dB CMRR
LTC2050/LTC2051/LTC2052	Zero-Drift Operational Amplifiers in SOT-23	3MHz GBW, 800µA, 3µV V_{OS} , V^- to V^+ – 1V In, RR Out, 2.7V to 6V, 130dB CMRR/PSRR
LTC1050/LTC1051/LTC1052	Precision Zero-Drift, Operational Amplifier with Internal Capacitors	2.5MHz GBW, 1mA, 5µV V_{OS} , V^- to V^+ – 2.3V In, RR Out, 4.75V to 16V, 120dB CMRR, 125dB PSRR
LTC6084/LTC6085	Dual/Quad 1.5MHz, Rail-to-Rail, CMOS Amplifiers	1.5MHz GBW, 110µA, 750µV V_{OS} , RR In/Out, 2.5V to 5.5V
LT1783	1.25MHz, Over-The-Top® Micropower, Rail-to-Rail Input and Output Op Amp in SOT-23	1.25MHz GBW, 300µA, 800µV V_{OS} , RR In/Out, 2.5V to 18V
LT1637/LT1638/LT1639	1.1MHz, 0.4V/µs Over-The-Top Micropower, Rail-to-Rail Input and Output Op Amps	1.1MHz GBW, 250µA, 350µV V_{OS} , RR In/Out, 2.7V to 44V, 110dB CMRR
LTC2054/LTC2055	Single/Dual Micropower Zero-Drift Operational Amplifiers	500kHz GBW, 150µA, 3µV V_{OS} , V^- to V^+ – 0.5V In, RR Out, 2.7V to 6V
LT6010/LT6011/LT6012	135µA, 14nV/√Hz, Rail-to-Rail Output Precision Op Amp with Shutdown	330kHz GBW, 135µA, 35µV V_{OS} , V^- + 1.0V to V^+ – 1.2V In, RR Out, 2.7V to 36V
LT1782	Micropower, Over-The-Top, SOT-23, Rail-to-Rail Input and Output Op Amp	200kHz GBW, 55µA, 800µV V_{OS} , RR In/Out, 2.5V to 18V
LT1636	Over-The-Top, Micropower Rail-to-Rail, Input and Output Op Amp	200kHz GBW, 50µA, 225µV V_{OS} , RR In/Out, 2.7V to 44V, –40°C to 125°C
LT1490A/LT1491A	Dual/Quad Over-The-Top, Micropower Rail-to-Rail Input and Output Op Amps	200kHz GBW, 50µA, 500µV V_{OS} , RR In/Out, 2V to 44V
LT2178/LT2179	17µA Max, Dual and Quad, Single Supply, Precision Op Amps	85kHz GBW, 17µA, 70µV V_{OS} , RR In/Out, 5V to 44V
LT6000/LT6001/LT6002	Single, Dual and Quad, 1.8V, 13µA Precision Rail-to-Rail Op Amps	50kHz GBW, 16µA, 600µV $V_{OS(MAX)}$, RR In/Out, 1.8V to 18V

626123fa