



## GaAs HBT VECTOR MODULATOR 1.8 - 2.2 GHz

### Typical Applications

The HMC500LP3(E) is ideal for:

- Wireless Infrastructure HPA & MCPA Error Correction
- Pre-Distortion or Feed-Forward Linearization
- PCS, GSM and W-CDMA Systems
- Beam Forming or RF Cancellation Circuits

### Features

- 360° of Continuous Phase Control
- Continuous Gain Control: 40 dB
- 162 dBm/Hz Output Noise Floor
- Input IP3: +33 dBm
- 16 Lead 3x3 mm SMT Package: 9mm<sup>2</sup>

### Functional Diagram

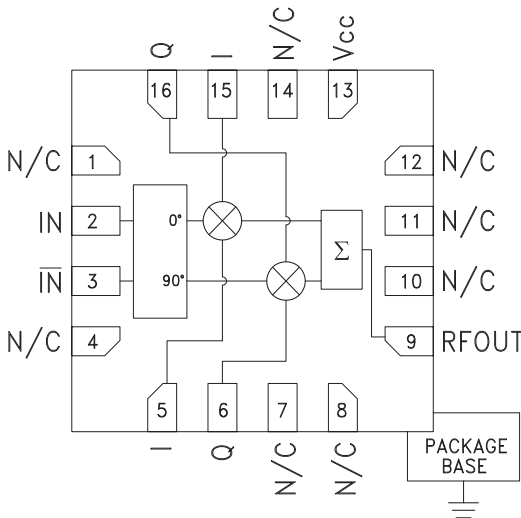

### General Description

The HMC500LP3(E) is a high dynamic range Vector Modulator RFICs which are targeted for RF predistortion and feed-forward cancellation circuits, as well as RF cancellation and beam forming amplitude/phase correction circuits. The I & Q ports of the HMC500LP3(E) can be used to continuously vary the phase and amplitude of RF signals by up to 360 degrees and 40 dB respectively, while supporting a 3 dB modulation bandwidth of 150 MHz. With an input IP3 of +33 dBm and input noise floor of -152 dBm/Hz (at -10 dB maximum gain setting), the input IP3/noise floor ratio is 185 dB.

### Electrical Specifications, $T_A = +25^\circ\text{C}$ , $V_{CC} = +8\text{V}$

Parameter	Min.	Typ.	Max.	Units
Frequency Range		1.8 - 2.2		GHz
Maximum Gain	-14	-10		dB
Gain Variation Over Temperature		0.012	0.02	dB / °C
Gain Flatness Across Any 60 MHz Bandwidth		0.15		dB
Gain Range		40		dB
Input Return Loss		17		dB
Output Return Loss		15		dB
Input Power for 1dB Compression (P1dB)	13	16		dBm
Input Third Order Intercept (IP3)		33		dBm
Output Noise		-162		dBm/Hz
Control Port Bandwidth (-3 dB)		150		MHz
Control Port Impedance		1.45k		Ohms
Control Port Capacitance		0.22		pF
Control Voltage Range		+0.5 to +2.5		Vdc
Group Delay Over 60 MHz Bandwidth		20		ps
Supply Current (Icq)		90		mA

Unless otherwise noted, measurements are made @ max. gain setting and 45° phase setting.  
See application circuit for details.



**GaAs HBT VECTOR MODULATOR 1.8 - 2.2 GHz**

**Maximum Gain vs. Temperature**

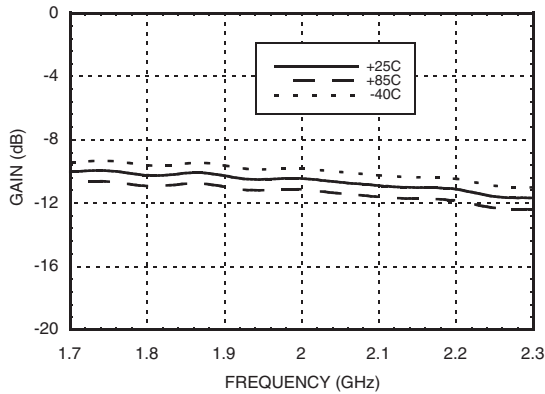

**Maximum Gain vs. Supply Voltage**

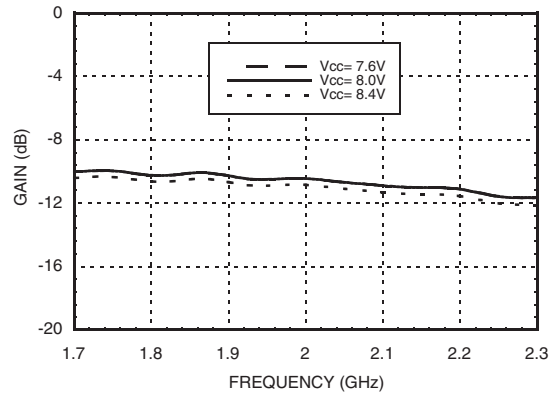

**Gain vs. Phase Settings @ F= 2 GHz**

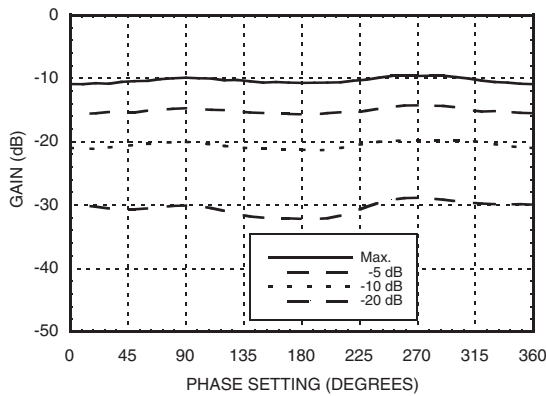

**Phase vs. Phase Settings @ F= 2 GHz vs. Various Gain Settings**

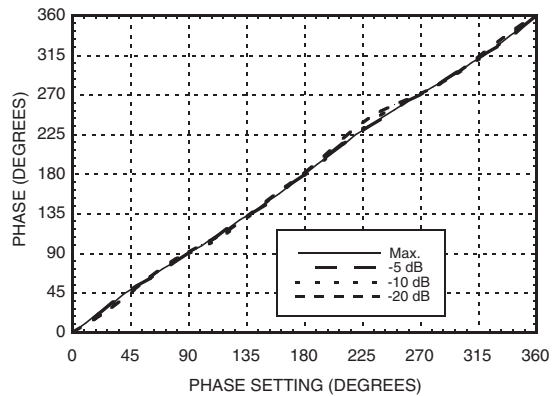

**Input Return Loss vs. Temperature**

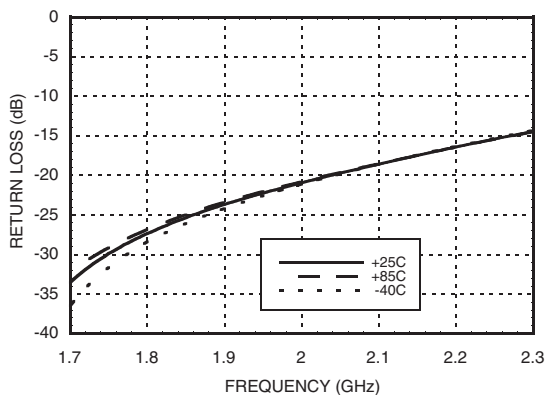

**Output Return Loss vs. Temperature**

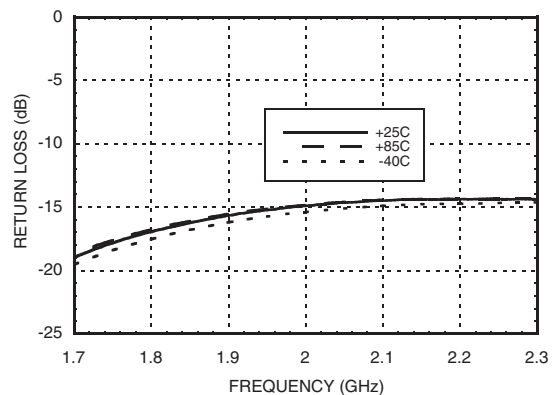

Information furnished by Analog Devices is believed to be accurate and reliable. However, no responsibility is assumed by Analog Devices for its use, nor for any infringements of patents or other rights of third parties that may result from its use. Specifications subject to change without notice. No license is granted by implication or otherwise under any patent or patent rights of Analog Devices. Trademarks and registered trademarks are the property of their respective owners.

For price, delivery, and to place orders: Analog Devices, Inc., One Technology Way, P.O. Box 9106, Norwood, MA 02062-9106 Phone: 781-329-4700 • Order online at [www.analog.com](http://www.analog.com) Application Support: Phone: 1-800-ANALOG-D



**GaAs HBT VECTOR MODULATOR 1.8 - 2.2 GHz**

**Output Noise vs. Temperature**

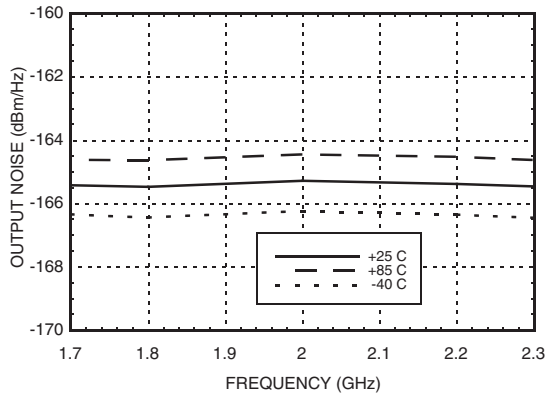

**Output Noise vs. Phase Settings @ F= 2 GHz**

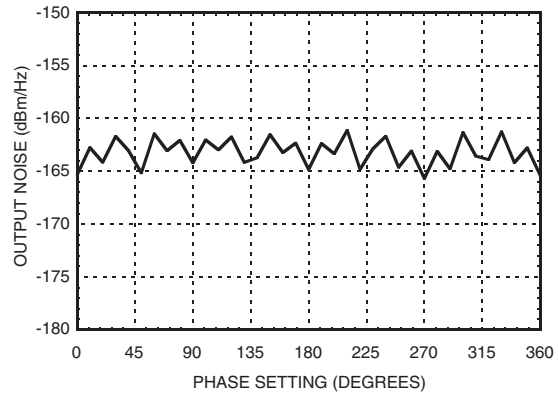

**Input P1dB vs. Temperature**

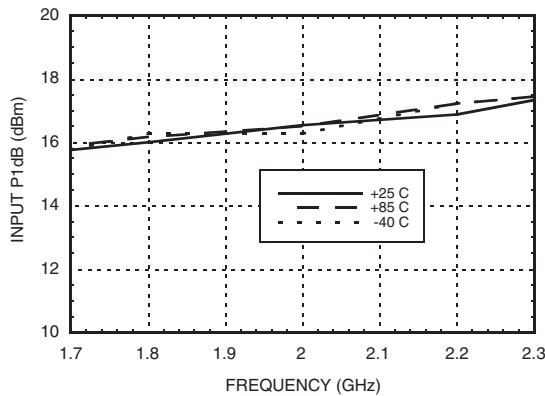

**Input IP3 vs. Temperature**

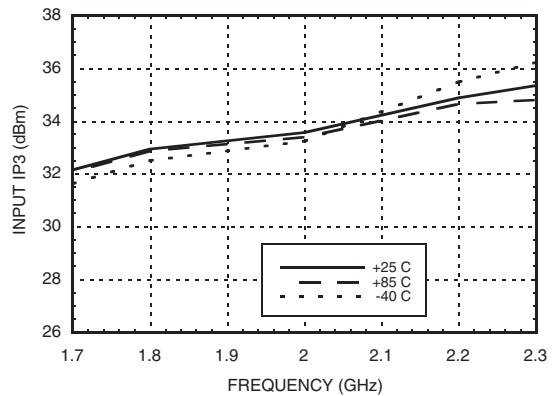

**Group Delay**

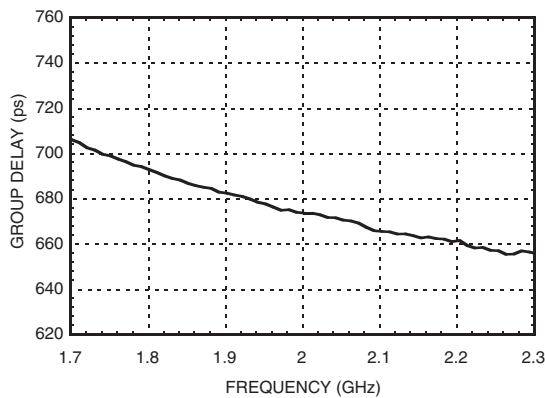

**Linear Gain vs. Phase Setting**

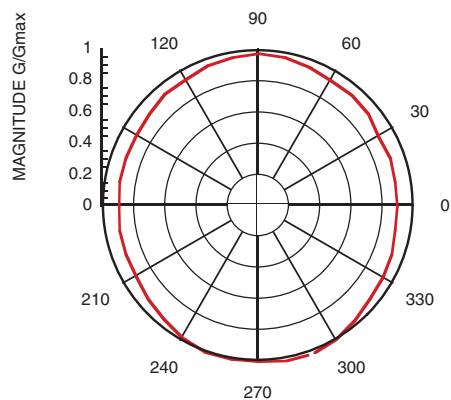

Information furnished by Analog Devices is believed to be accurate and reliable. However, no responsibility is assumed by Analog Devices for its use, nor for any infringements of patents or other rights of third parties that may result from its use. Specifications subject to change without notice. No license is granted by implication or otherwise under any patent or patent rights of Analog Devices. Trademarks and registered trademarks are the property of their respective owners.

For price, delivery, and to place orders: Analog Devices, Inc., One Technology Way, P.O. Box 9106, Norwood, MA 02062-9106 Phone: 781-329-4700 • Order online at [www.analog.com](http://www.analog.com) Application Support: Phone: 1-800-ANALOG-D

## GaAs HBT VECTOR MODULATOR 1.8 - 2.2 GHz



### Typical Supply Current vs. Vcc

Vcc (V)	Icc (mA)
7.6	85
8.0	90
8.4	95

Note:  
Modulator will operate over full voltage range shown above.



**ELECTROSTATIC SENSITIVE DEVICE  
OBSERVE HANDLING PRECAUTIONS**

### Absolute Maximum Ratings

RF Input (Vcc = +8V)	27 dBm
Supply Voltage (Vcc)	+10V
I & Q Input	-0.5V to +5.0V
Channel Temperature (Tc)	135 °C
Continuous P <sub>diss</sub> (T = 85°C) (Derate 25 mW/°C above 85°C)	1.25 W
Thermal Resistance (R <sub>th</sub> ) (junction to ground paddle)	40 °C/W
Storage Temperature	-65 to +150 °C
Operating Temperature	-40 to +85 °C

### Outline Drawing

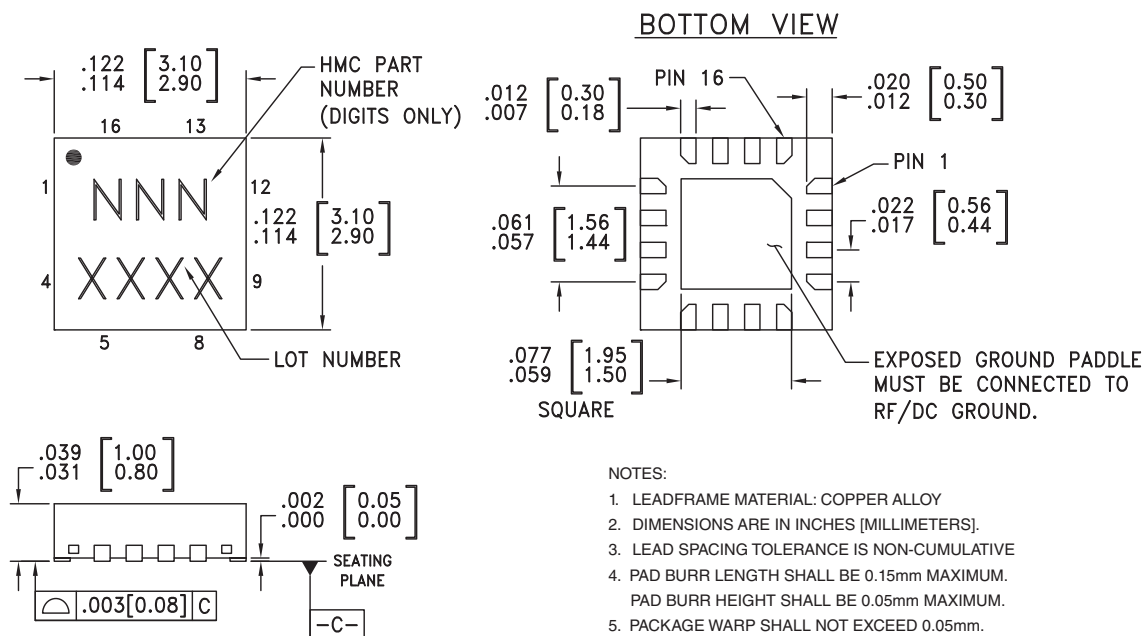

**NOTES:**

- LEADFRAME MATERIAL: COPPER ALLOY
- DIMENSIONS ARE IN INCHES [MILLIMETERS].
- LEAD SPACING TOLERANCE IS NON-CUMULATIVE
- PAD BURR LENGTH SHALL BE 0.15mm MAXIMUM.  
PAD BURR HEIGHT SHALL BE 0.05mm MAXIMUM.
- PACKAGE WARP SHALL NOT EXCEED 0.05mm.
- ALL GROUND LEADS AND GROUND PADDLE MUST BE SOLDERED TO PCB RF GROUND.
- REFER TO HITTITE APPLICATION NOTE FOR SUGGESTED PCB LAND PATTERN.

### Package Information

Part Number	Package Body Material	Lead Finish	MSL Rating	Package Marking <sup>[3]</sup>
HMC500LP3	Low Stress Injection Molded Plastic	Sn/Pb Solder	MSL1 <sup>[1]</sup>	500 XXXX
HMC500LP3E	RoHS-compliant Low Stress Injection Molded Plastic	100% matte Sn	MSL1 <sup>[2]</sup>	500 XXXX

[1] Max peak reflow temperature of 235 °C

[2] Max peak reflow temperature of 260 °C

[3] 4-Digit lot number XXXX

## GaAs HBT VECTOR MODULATOR 1.8 - 2.2 GHz



### Pin Description

Pin Number	Function	Description	Interface Schematic
1, 4, 7, 8, 10 - 12, 14	N/C	No connection. These pins may be connected to RF/DC ground. Performance will not be affected	
2, 3	IN, $\bar{IN}$	Differential RF inputs, 50 Ohms. Must be DC blocked.	
5, 15	I	In-phase control input. Pins 5 and 15 are redundant. Either input can be used.	
6, 16	Q	Quadrature control input. Pins 6 and 16 are redundant. Either input can be used.	
9	RFOUT	RF Output: Must be DC blocked.	
13	Vcc	Supply Voltage	
	GND	Ground: Backside of package has exposed metal ground slug which must be connected to RF/DC ground.	



## GaAs HBT VECTOR MODULATOR 1.8 - 2.2 GHz

### Application Circuit

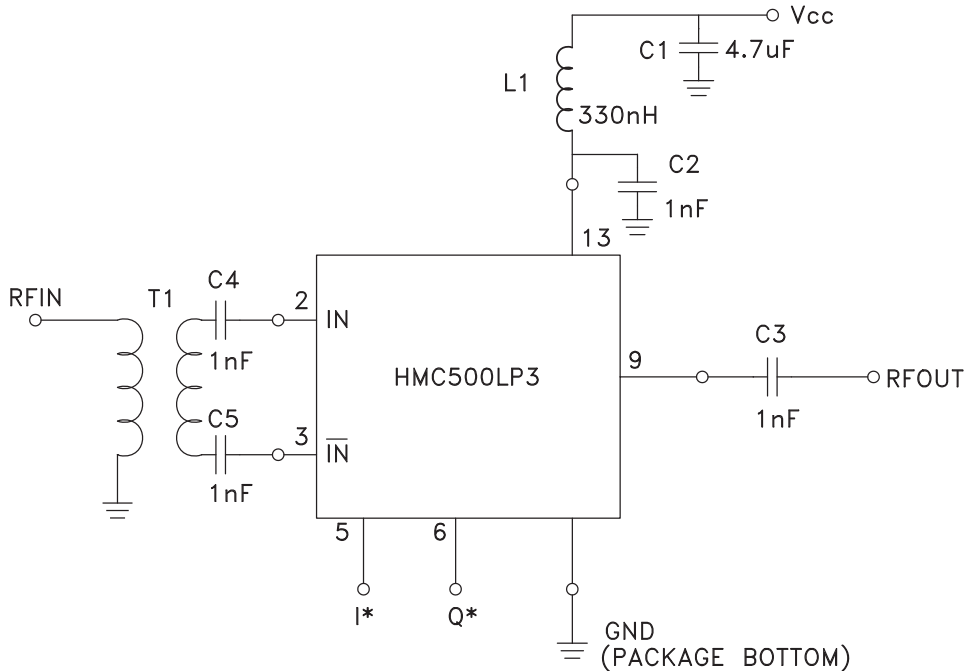

\* Pins 15 & 16 are redundant I & Q inputs.

Gain and Phase control are applied through the I and Q control ports. For a given linear gain (G) and phase ( $\theta$ ) setting, the voltages applied to these ports in all measurements are calculated as follows:

$$I(G, \theta) = V_{mi} + 1.0V \frac{G}{G_{max}} \cos(\theta)$$

$$Q(G, \theta) = V_{mq} + 1.0V \frac{G}{G_{max}} \sin(\theta)$$

Where  $V_{mi}$  and  $V_{mq}$  are the I and Q voltage settings corresponding to maximum isolation at room temperature and  $F = 2$  GHz.

Note that  $G = 10^x$  and  $G_{max} = 10^y$  where  $x = \frac{\text{Gain Setting (dB)}}{20}$  and  $y = \frac{\text{Max Gain Setting (dB)}}{20}$ . Nominally  $V_{mi} = V_{mq} = 1.5V$ ,  $G_{max} = 0.316$ .



**GaAs HBT VECTOR  
MODULATOR 1.8 - 2.2 GHz**

**Evaluation PCB**

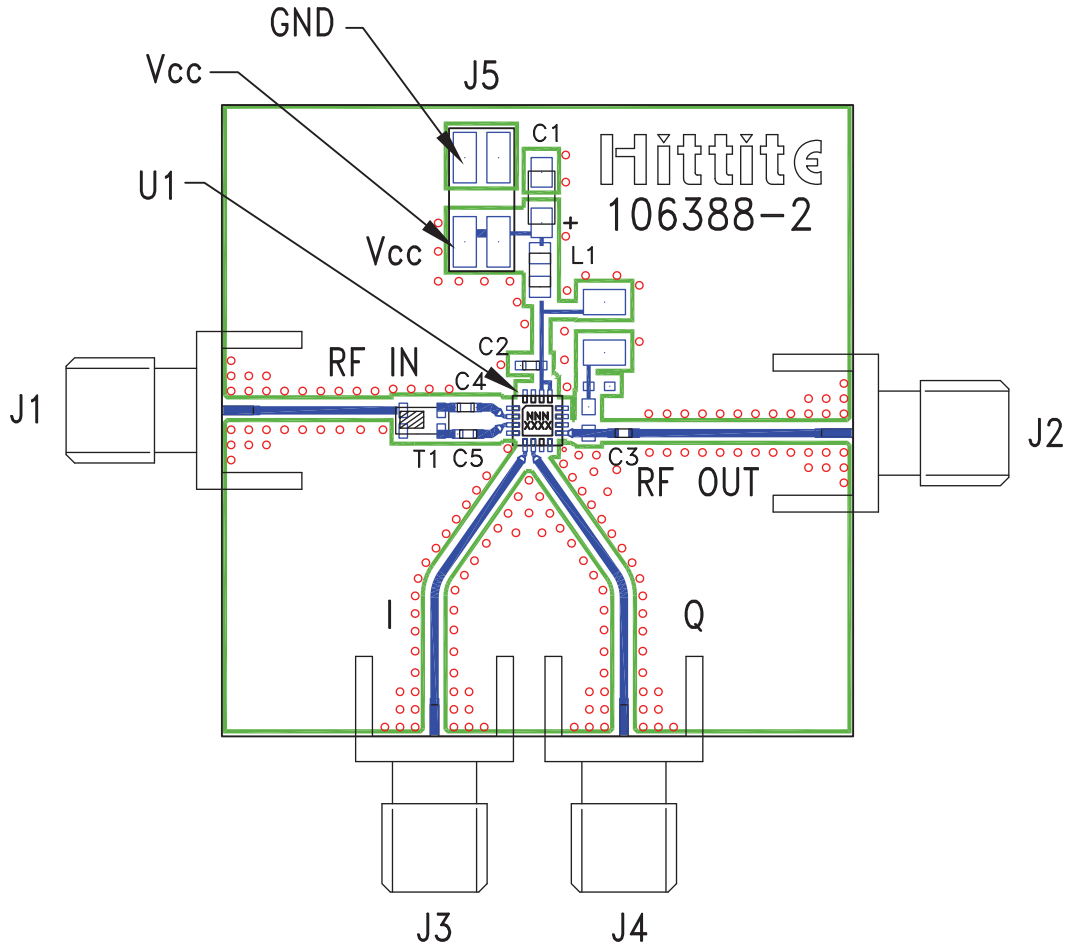

**List of Materials for Evaluation PCB 106395 [1]**

Item	Description
J1 - J4	PCB Mount SMA Connector
J5	2 mm DC Header
C1	4.7 $\mu$ F Capacitor, Tantalum
C2 - C5	1 nF Capacitor, 0402 Pkg.
T1	Balun, 1206 Pkg.
L1	330 nH Inductor, 0805 Pkg.
U1	HMC500LP3 / HMC500LP3E Vector Modulator
PCB [2]	106388 Evaluation PCB

[1] Reference this number when ordering complete evaluation PCB

[2] Circuit Board Material: Rogers 4350, Er = 3.48

The circuit board used in the final application should use RF circuit design techniques. Signal lines should have 50 ohm impedance while the package ground leads and exposed paddle should be connected directly to the ground plane similar to that shown. A sufficient number of via holes should be used to connect the top and bottom ground planes. The evaluation board should be mounted to an appropriate heat sink. The evaluation circuit board shown is available from Hittite upon request.

**Notes:****HMC500LP3 / 500LP3E**

v02.1109

**GaAs HBT VECTOR  
MODULATOR 1.8 - 2.2 GHz****10****MODULATORS - VECTOR - SMT**