

AX3



ESD Sensitive



3.2 x 2.5 x 1.0 mm
RoHS/RoHS II Compliant
MSL = 1

Features

- Exceptionally Low RMS Jitter: < 80fs Typ (150fs Max @ 156.25MHz)
- Available in industry standard frequencies between 100MHz and 212.5MHz
- Lowest power consumption in its class (16mA Typ LVDS @ 156.25MHz)
- ±25ppm stability over industrial operating temperature (-40 to +85°C)
- 3.3V, 2.5V, 1.8V supply voltage options
- LVPECL, LVDS, HCSL differential outputs
- Industry standard 3.2 x 2.5 x 1.0 mm footprint
- Available in Abracon's Global Distribution Network

Applications

- PCI Express
- 10G/40G/100G optical Ethernet
- Networking & communication
- RF systems, base stations (BTS)
- Data center
- Test & measurement

Options and Part Identification [Note 1]

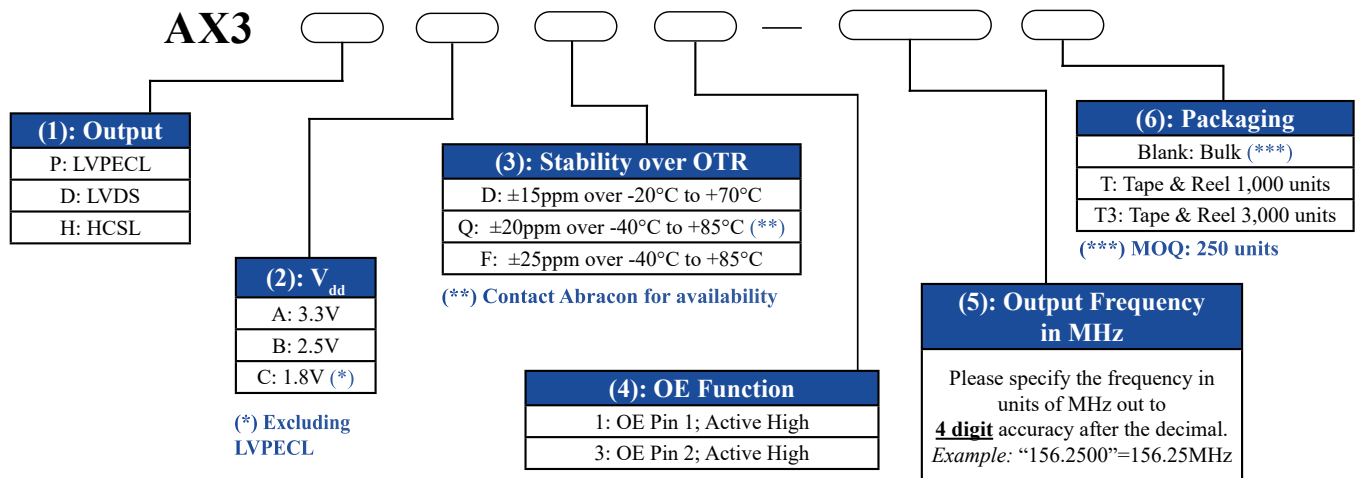

Part Number Example:

AX3PAF1-156.2500
AX3PAF1-156.2500T
AX3PAF1-156.2500T3

Note 1: Contact Abracon for non-standard configurations and/or requests with carrier frequency callouts up to 5 & 6 digit accuracy after the decimal.

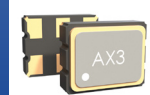

AX3



ESD Sensitive



3.2 x 2.5 x 1.0 mm
RoHS/RoHS II Compliant
MSL = 1

Electrical Characteristics

Parameters		Min.	Typ.	Max.	Unit	Notes
Frequency Range		100		212.500	MHz	
Standard Available Frequencies		100, 114.285, 122.88, 125, 148.5, 150, 155.52, 156.25, 200, 212.500			MHz	Contact Abracon for availability of frequencies not listed
Supply Voltage (V_{dd}) [Note 2]		2.97	3.3	3.63	V	Option "A"
		2.37	2.5	2.62		Option "B"
		1.71	1.8	1.89		Option "C"
Supply Current (I_{dd})	LVPECL		30	50	mA	@ 200MHz; @ $V_{dd} = 3.3V$
	LVDS		16	27		@ 200MHz; @ $V_{dd} = 3.3V$
	HCSL		17	30		@ 200MHz; @ $V_{dd} = 3.3V$
Operating Temperature Range		-20		+70	°C	Option "D"
		-40		+85		Option "F" or "Q"
Storage Temperature		-55		+150	°C	
Frequency Accuracy (Initial Set-Tolerance) at time of shipment (Pre-Reflow) @ +25°C		-10	< ±5	+10	ppm	Relative to carrier frequency
Frequency Stability over [Note 3,4] Operating Temperature Range		-15		+15	ppm	Option "D" (-20°C to +70°C)
		-20		+20		Option "Q" (-40°C to +85°C)
		-25		+25		Option "F" (-40°C to +85°C)
Aging over 20 Year Product Life [Note 5]		-15		+15	ppm	
All-Inclusive Frequency Accuracy (Total Stability) over 20 Year Product Life [Note 5, 6]		-40		+40	ppm	Option "D" (-20°C to +70°C)
		-45		+45		Option "Q" (-40°C to +85°C)
		-50		+50		Option "F" (-40°C to +85°C)
Rise (Tr) / Fall (Tf) Time 20% to 80% $V_{peak\ to\ peak}$	LVPECL		0.2	0.4	ns	@ $V_{dd} = 3.3V, R_L = 50\Omega$
			0.3	0.6		@ $V_{dd} = 2.5V, R_L = 50\Omega$
			0.15	0.4		@ $V_{dd} = 3.3V, R_L = 100\Omega$
	LVDS		0.15	0.4		@ $V_{dd} = 2.5V, R_L = 100\Omega$
			0.3	0.5		@ $V_{dd} = 1.8V, R_L = 100\Omega$
			0.3	0.5		@ $V_{dd} = 3.3V, R_L = 50\Omega\ to\ GND$
	HCSL		0.3	0.5		@ $V_{dd} = 2.5V, R_L = 50\Omega\ to\ GND$
			0.3	0.5		@ $V_{dd} = 3.3V, R_L = 50\Omega\ to\ GND$
			0.3	0.6		@ $V_{dd} = 1.8V, R_L = 50\Omega\ to\ GND$
Duty Cycle		45		55	%	
Start-up Time [Note 3]			< 2	5.0	ms	

Note 2: Supply Voltage (V_{dd}) = 1.8V option not available with LVPECL output

Note 3: Relative to initial measured frequency @ +25°C

Note 4: Option Q only available in select frequencies. Please contact Abracon for availability

Note 5: Relative to post-reflow frequency

Note 6: Includes temperature stability, initial frequency accuracy, load pulling, power supply variation, and 20-year aging

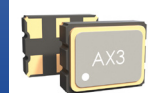

AX3



ESD Sensitive



3.2 x 2.5 x 1.0 mm
RoHS/RoHS II Compliant
MSL = 1

Electrical Characteristics Cont.

Parameters		Min.	Typ.	Max.	Unit	Notes
Differential Output High Voltage (V_{OH}) Output Low Voltage (V_{OL})	LVPECL	V_{OH}	$V_{dd} - 1.03$		$V_{dd} - 0.88$	$R_L = 50\Omega$ to $V_{dd} - 2.0V$
		V_{OL}	$V_{dd} - 1.85$		$V_{dd} - 1.60$	
	LVDS	V_{OH}		1.40	1.60	$R_L = 100\Omega$ between both outputs
		V_{OL}	0.90	1.10		
	HCSL	V_{OH}	0.40	0.74	0.85	$R_L = 50\Omega$ to ground on each output
		V_{OL}	-0.15	0.00	0.15	
Output Voltage Swing			0.595	0.75	0.93	V LVPECL LVDS HCSL
			0.25	0.35	0.45	
			0.620	0.70	0.78	
Output Enable & Disable Control			$0.7*(V_{dd})$			V Output Enable; or No Connect Output Disable; High Impedance
					$0.3*(V_{dd})$	
Output Enable Time			< 1	5.0	ms	
Output Disable Time				0.2	μs	
Output Disable Current Consumption				< 10	μA	$OE \leq 0.3V$

RMS Phase Jitter (12kHz -20MHz BW) | $V_{dd} = 3.3V$ [Note 7, 8, 9]

Frequency (MHz)	Output	RMS Jitter	
		Typ. (fs)	Max (fs)
100	HCSL	153	200
	LVPECL	211	300
	LVDS	304	500
114.285	LVPECL	264	500
	LVDS	239	500
122.88	HCSL	122	200
	LVPECL	228	300
	LVDS	198	300
125	HCSL	138	200
	LVPECL	91	150
	LVDS	186	300
148.5	LVPECL	154	200
	LVDS	158	200
150	LVPECL	154	200
	LVDS	153	200
155.52	LVPECL	121	150
156.25	HCSL	113	150
	LVPECL	75	150
	LVDS	115	150
200	LVDS	70	150
	LVPECL	140	200
	HCSL	140	200
212.5	LVDS	60	150
	LVPECL	130	200
	HCSL	130	200

Note 7: Guaranteed by characterization; RMS Phase Jitter specifications are inclusive of any spurs

Note 8: Phase jitter measured with Keysight E5052B Signal Source Analyzer

Note 9: Refer to the next section for phase noise test setup and representative phase noise plots

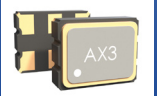

AX3



ESD Sensitive



3.2 x 2.5 x 1.0 mm
RoHS/RoHS II Compliant
MSL = 1

Phase Noise Test Setup [Note 10]

- Keysight E5052B Signal Source Analyzer
- Integration Bandwidth = 12kHz to 20MHz
- Spurious Activity (entire plot trace) = Not Omitted (Normalized in dBc/Hz)
- Specified Spur Omission Function = Not Enabled
- IF Gain = 20dB
- Correlation = 5
- Average = 3

F=156.2500MHz | V_{dd}=3.3V | LVPECL
RMS Phase Jitter = 75 fs

F=156.2500MHz | V_{dd}=3.3V | HCSL
RMS Phase Jitter = 113 fs

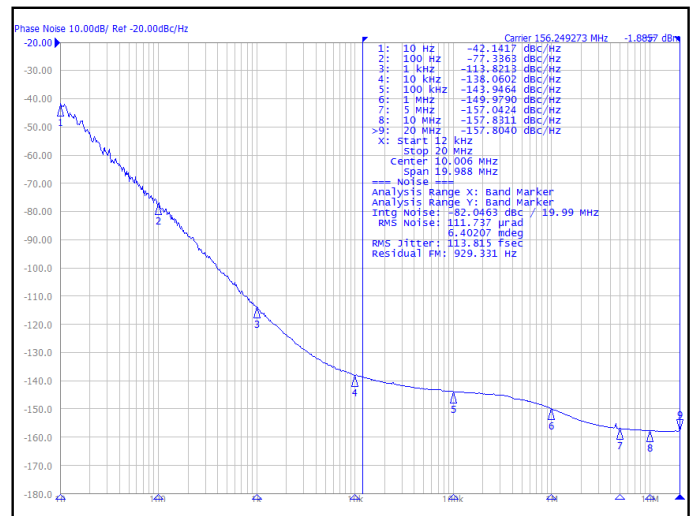
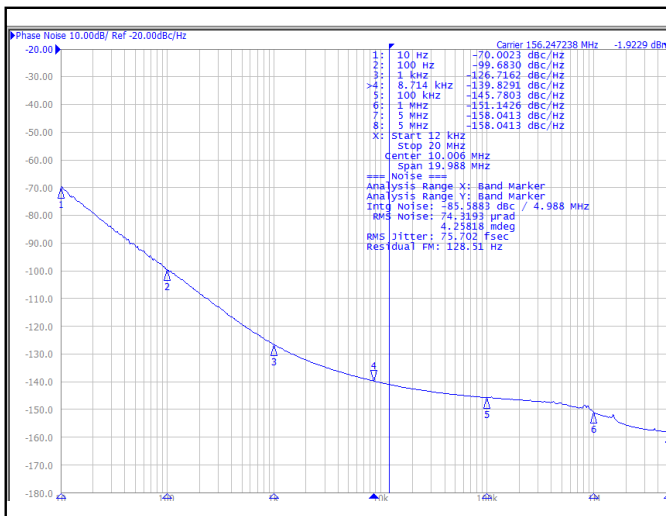

F= 156.2500MHz | V_{dd}=3.3V | LVDS
RMS Phase Jitter = 115 fs

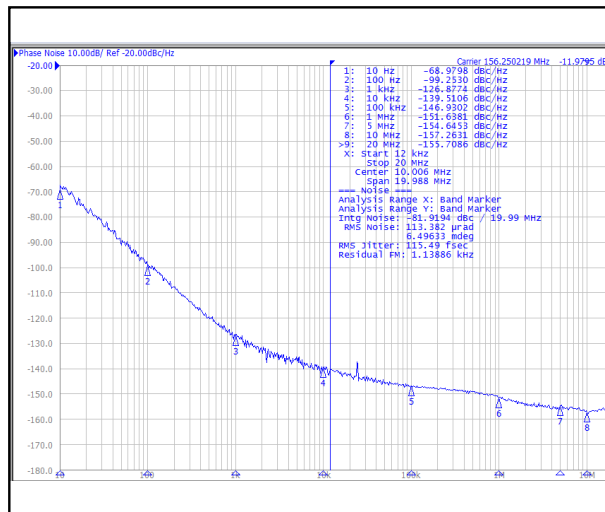

Note 10: Contact Abracon for phase noise plots at any desired combination of V_{dd}, differential output format, and carrier frequency within the available range

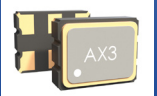

AX3



ESD Sensitive



3.2 x 2.5 x 1.0 mm
RoHS/RoHS II Compliant
MSL = 1

Representative Phase Noise Plots Cont. [Note 10]

F=100.0000MHz | V_{dd}=3.3V | LVPECL
RMS Phase Jitter = 211 fs

F= 100.0000MHz | V_{dd}=3.3V | LVDS
RMS Phase Jitter = 304 fs

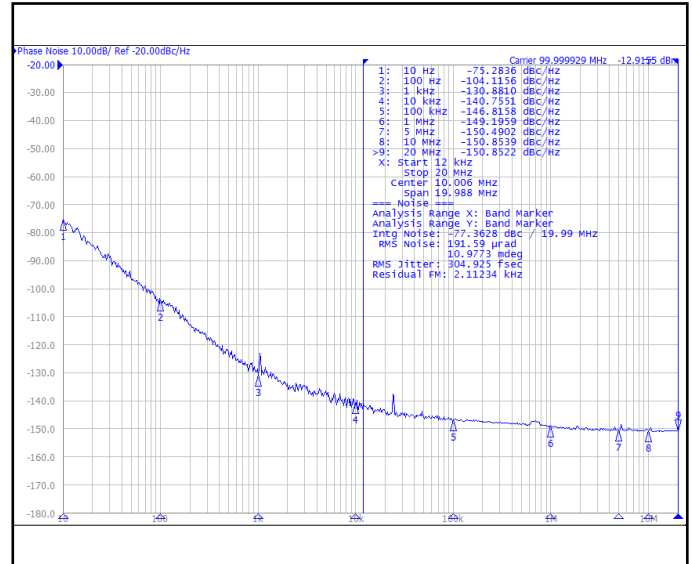
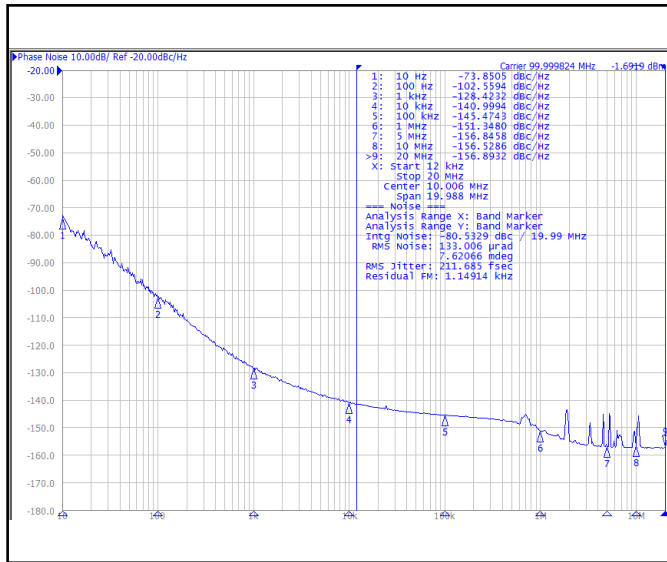

F= 100.0000MHz | V_{dd}=3.3V | HCSSL
RMS Phase Jitter = 153 fs

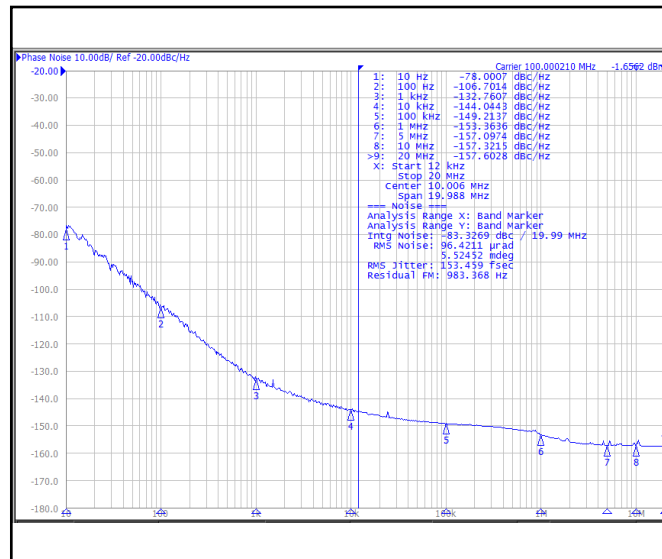

Note 10: Contact Abracon for phase noise plots at any desired combination of V_{dd}, differential output format, and carrier frequency within the available range

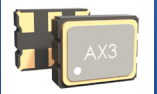

AX3



ESD Sensitive



3.2 x 2.5 x 1.0 mm
RoHS/RoHS II Compliant
MSL = 1

Representative Phase Noise Plots Cont. [Note 10]

F=125.0000MHz | V_{dd}=3.3V | LVDS
RMS Phase Jitter = 186 fs

F= 125.0000MHz | V_{dd}=3.3V | HCSL
RMS Phase Jitter = 138 fs

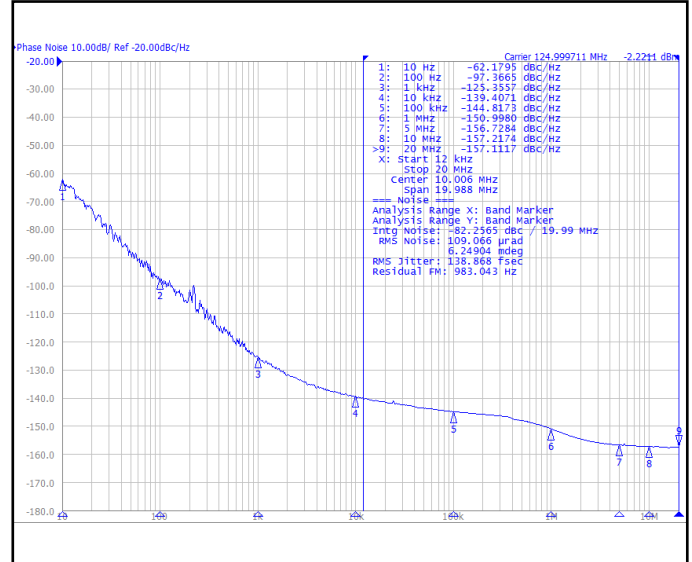
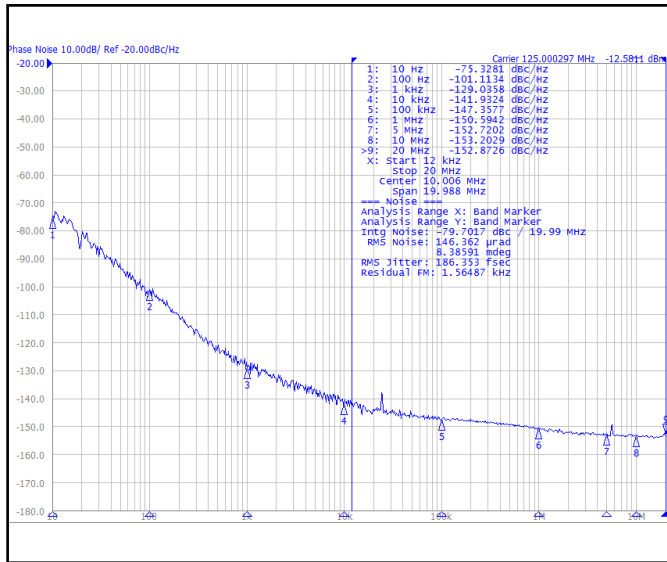

F= 125.0000MHz | V_{dd}=3.3V | LVPECL
RMS Phase Jitter = 91 fs

F= 212.5000MHz | V_{dd}=3.3V | LVDS
RMS Phase Jitter = 57 fs

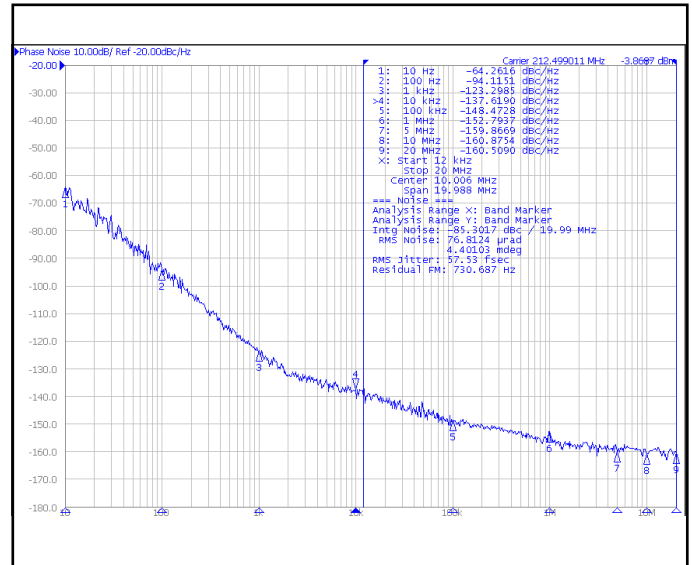
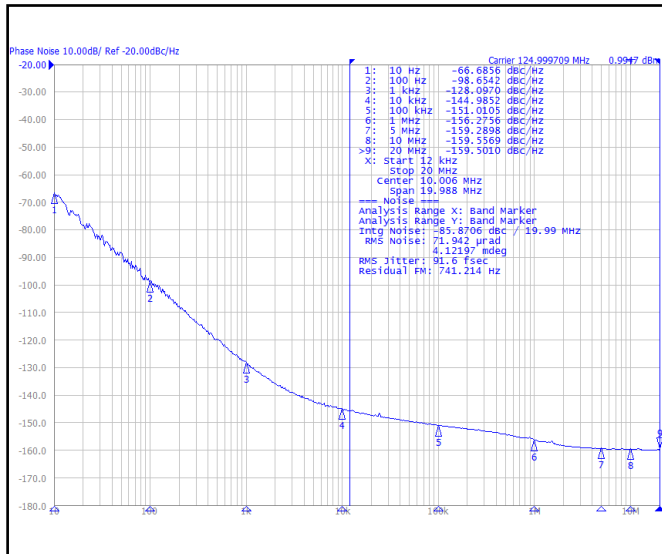

Note 10: Contact Abracon for phase noise plots at any desired combination of V_{dd}, differential output format, and carrier frequency within the available range

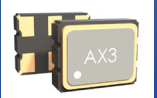

AX3



ESD Sensitive



3.2 x 2.5 x 1.0 mm
RoHS/RoHS II Compliant
MSL = 1

Typical Frequency vs. Temperature Characteristics

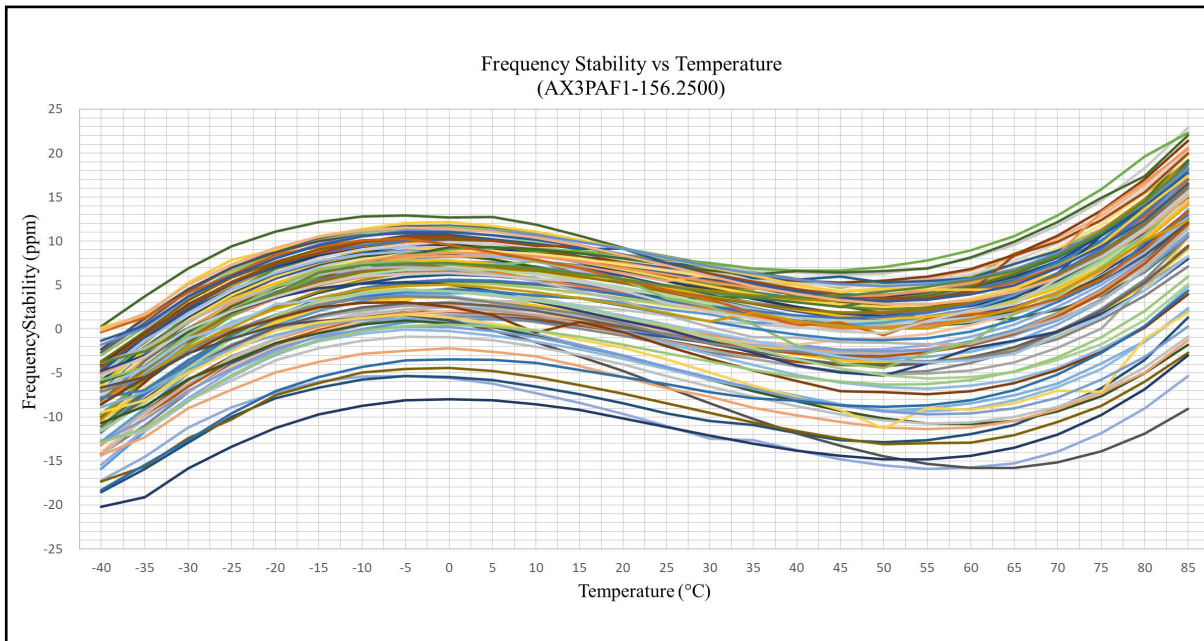
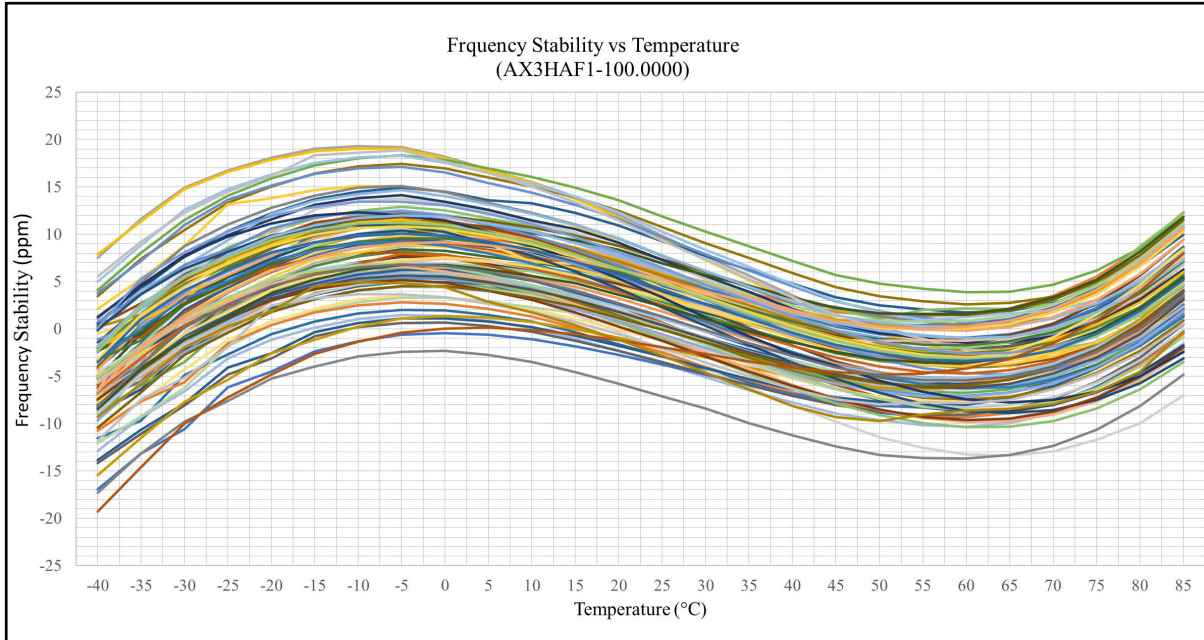

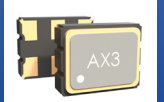

AX3



ESD Sensitive



3.2 x 2.5 x 1.0 mm
RoHS/RoHS II Compliant
MSL = 1

Differential Output Waveform

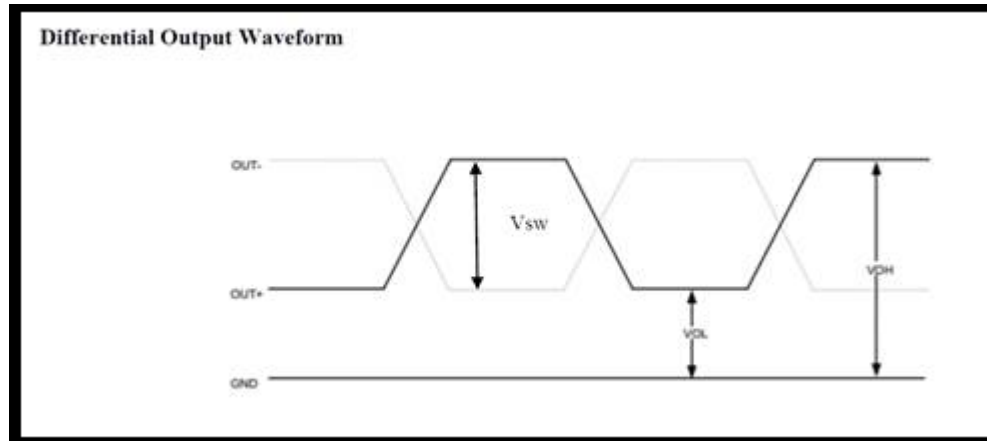

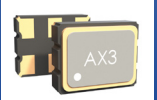

AX3



ESD Sensitive

3.2 x 2.5 x 1.0 mm
RoHS/RoHS II Compliant
MSL = 1

Recommended Test Circuit [Note 11]

LVPECL

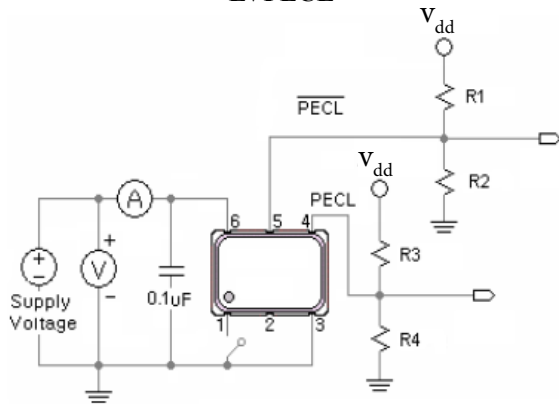

$V_{dd}=3.3V$: $R1=R3=127\Omega$; $R2=R4=82.5\Omega$
 $V_{dd}=2.5V$: $R1=R3=250\Omega$; $R2=R4=62.5\Omega$

LVDS

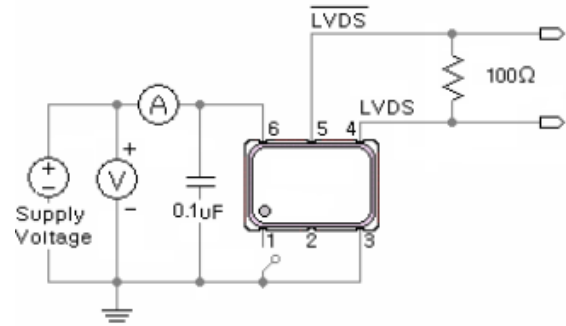

HCSL

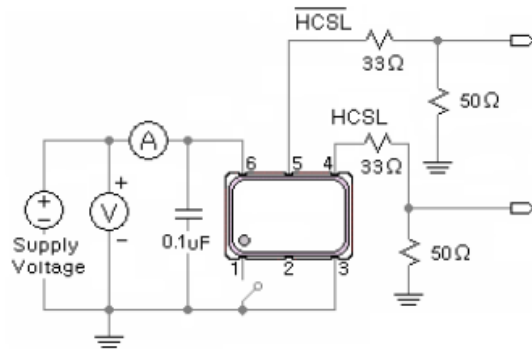

Note 11: Recommended test circuit images display OE Functions Option 1 & Option 2 where the OE Function is located on Pin 1
 When the OE Function is located on Pin 2, then Pin 1=No Connect & Pin 2=OE or No Connect

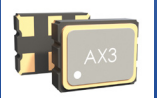

AX3



ESD Sensitive



3.2 x 2.5 x 1.0 mm
RoHS/RoHS II Compliant
MSL = 1

Mechanical Dimensions

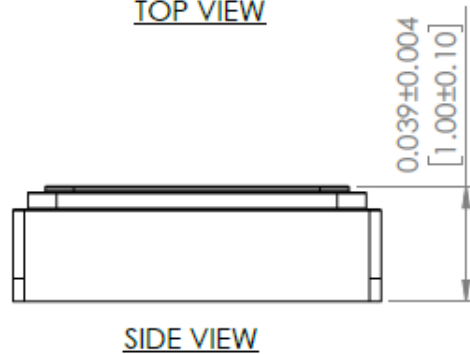
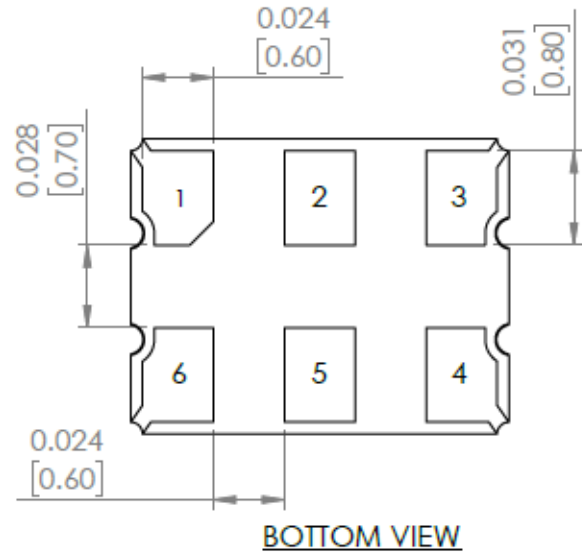
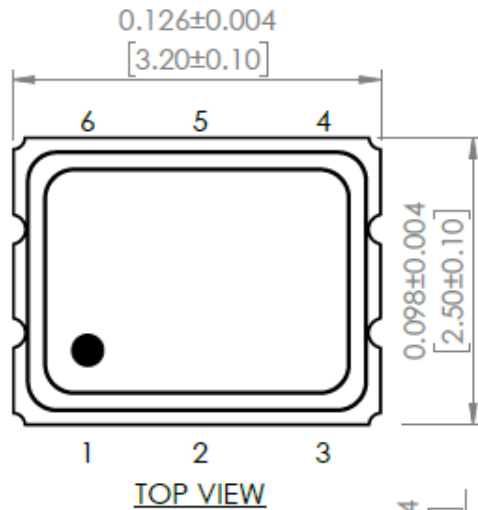

Recommended Land Pattern

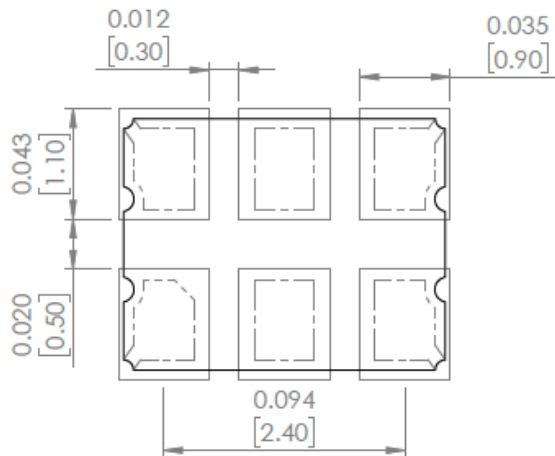

Case 1 Pin #1=Output Enable/Disable Function where OE is Active HIGH		Case 2 Pin #2=Output Enable/Disable Function where OE is Active HIGH	
Pin	Description	Pin	Description
# 1	Output Enable = Logic High, "1", V _{dd}	# 1	No Connect
	Output Disable = Logic Low, "0", GND	# 2	Output Enable = Logic High, "1", V _{dd}
# 2	No Connect		Output Disable = Logic Low, "0", GND
# 3	GND	# 3	GND
# 4	Output	# 4	Output
# 5	Complementary output	# 5	Complementary output
# 6	Supply Voltage (V _{dd})	# 6	Supply Voltage (V _{dd})

Dimensions: inches [mm]

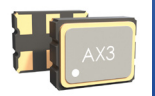

AX3



ESD Sensitive



3.2 x 2.5 x 1.0 mm
RoHS/RoHS II Compliant
MSL = 1

Recommended Reflow Profile

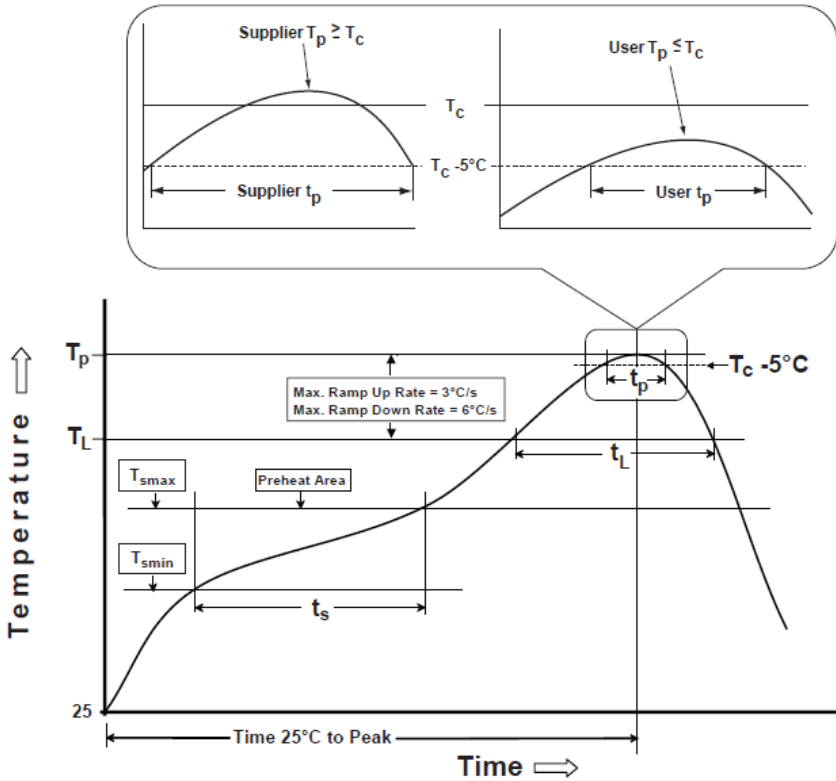

Table 1

SnPb Eutectic Process Classification Temperatures (T_c)		
Package Thickness	Volume mm ³ <350	Volume mm ³ >350
<2.5 mm	235 °C	220 °C
>2.5 mm	220 °C	220 °C

Table 2

Pb-Free Process Classification Temperatures (T_c)			
Package Thickness	Volume mm ³ <350	Volume mm ³ >350	Volume mm ³ >2000
<1.6 mm	260 °C	260 °C	260 °C
1.6 mm - 2.5 mm	260 °C	250 °C	245 °C
>2.5 mm	250 °C	245 °C	245 °C

Profile Feature	Sn-Pb Eutectic Assembly	Pb-Free Assembly
Preheat / soak		
Temperature minimum (T_{smin})	100°C	150°C
Temperature maximum (T_{smax})	150°C	200°C
Time (T_{smin} to T_{smax}) (t_s)	60 - 120 sec.	60 - 120 sec.
Average ramp-up rate (T_{smax} to T_p)	3°C/sec. max	3°C/sec. max
Liquidous temperature (T_L)	183°C	217°C
Time at liquidous (t_L)	60 - 150 sec.	60 - 150 sec.
Peak package body temperature (T_p)*	see Table 1	see Table 2
Time (t_p)** within 5°C of the specified classification temperature (T_c)	20 sec.	30 sec.
Ramp-down rate (T_p to T_{smax})	6°C/sec. max	6°C/sec. max
Time 25°C to peak temperature	6 min. max	8 min. max
*Tolerance for peak profile temperature (TP) is defined as a supplier minimum and a user maximum.		
**Tolerance for time at peak profile temperature (tp) is defined as supplier minimum and a user maximum.		

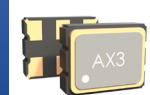

AX3



ESD Sensitive



3.2 x 2.5 x 1.0 mm
RoHS/RoHS II Compliant
MSL = 1

Packaging

Blank = Bulk (MOQ = 250 units)

T = Tape & Reel 1,000 units/reel

T3 = Tape & Reel 3,000 units/reel

Feeding (PULL) Direction →

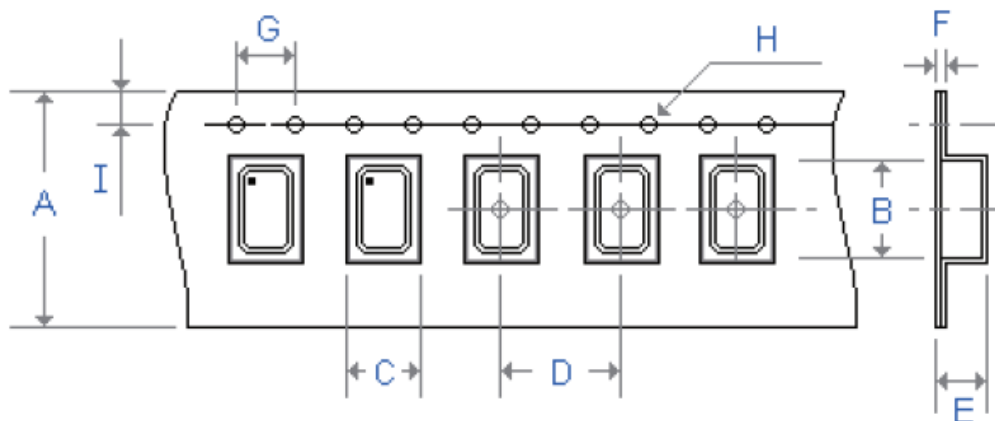

Tape Dimensions	
A	8.00
B	3.40
C	2.70
D	4.00
E	1.40
F	0.30
G	4.00
H	Ø1.55
I	1.75
Reel Dimensions	
J	180.00
K	10.90
L	11.40
M	13.20
N	2.20
O	22.00

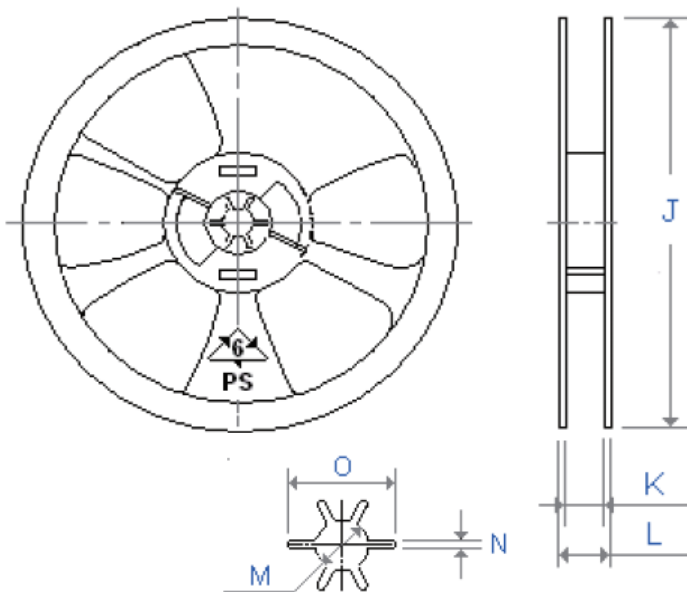

Dimensions: mm

ATTENTION: Abracon LLC's products are COTS – Commercial-Off-The-Shelf products; suitable for Commercial, Industrial and, where designated, Automotive Applications. Abracon's products are not specifically designed for Military, Aviation, Aerospace, Life-dependent Medical applications or any application requiring high reliability where component failure could result in loss of life and/or property. For applications requiring high reliability and/or presenting an extreme operating environment, written consent and authorization from Abracon LLC is required. Please contact Abracon LLC for more information.



5101 Hidden Creek Ln Spicewood TX 78669
Phone: 512-371-6159 | Fax: 512-351-8858
For terms and conditions of sales, please visit:
www.abracon.com

REVISED: 11.16.2020

ABRACON IS
ISO9001-2015
CERTIFIED