



7.0 x 5.0 x 1.9mm

AST3TQ



ESD Sensitive



RoHS/RoHS II Compliant

Moisture Sensitivity Level (MSL) – 3

➤ **FEATURES:**

- Standard available frequencies: 10.00, 12.80, 19.20, 20.00, 25.00, 26.00, 30.72, 40.00, 50.00MHz
- Standard LVC MOS Output
- Frequency stabilities to include ± 100 ppb over -40°C to $+85^{\circ}\text{C}$, ± 280 ppb over -50°C to $+90^{\circ}\text{C}$ and ± 500 ppb over -55°C to $+95^{\circ}\text{C}$ operating temperature range
- Excellent Phase Noise, Harmonics and Spurious content
- Typical rms jitter of 400fs @ 40MHz carrier & 1.0ps @ 10MHz carrier over 12kHz to 20MHz BW

➤ **APPLICATIONS:**

- COTS Military Radios & other Communication Hardware
- WiMax,
- LTE, BTS
- CATV, LAN, LMDS
- GPS Tracking with Hold-Over accuracy
- Test & Measurement Equipment
- Point-to-Point communication networks

➤ **STANDARD SPECIFICATIONS:**

Maximum Rating

Parameters	Rating
Storage Temperature Range	-55 to +125 °C
Supply Voltage	-0.5 to 6V
ESD, HBM/CDM/MM	4kV/2kV/200V

Parameters	Minimum	Typical	Maximum	Units	Notes
Frequency Range	10		51.2	MHz	
Standard Frequencies:	10.00, 12.80, 19.20, 20.00, 25.00, 26.00, 30.72, 40.00, 50.00			MHz	
Initial Frequency Tolerance (@+25°C) at shipping			± 0.3	ppm	Relative to carrier
Frequency Stability Options					
-40°C to +85°C			± 100	ppb	Option "1"
-50°C to +90°C			± 280	ppb	Option "2"* Note 1
-55°C to +95°C			± 500	ppb	Option "5"* Note 2
Frequency Stability vs. Supply Voltage Change (Vdd $\pm 5\%$):			± 100	ppb	
Frequency Stability vs. Load Change (Load $\pm 5\%$):			± 200	ppb	
Supply Voltage (Vdd):	+3.135	+3.3	+3.465	V	
Aging (first year @+25°C):			± 1.0	ppm	
Aging (20 years @+25°C):		± 3.0	± 4.6	ppm	
Supply Current (Icc) (into 15pF load):		7.8	8.5	mA	@10MHz carrier
		8.7	9.5		@16.384MHz carrier
		13.7	14.5		@51.2MHz carrier
CMOS Output					
V _{OH} :	2.4			V	Load=15pF
V _{OL} :			0.4	V	Load=15pF
Load:			15	pF	
Duty Cycle:	45		55	%	@(V _{OH} - V _{OL})/2
Rise/Fall Time:			4	ns	Load=15pF
Waveform:	Square Wave				
RMS Jitter (12kHz to 20MHz BW)	0.4		1.3	ps	Carrier dependent
Phase Noise (10MHz carrier frequency @25 °C):			-95	dBc/Hz	Offset @10Hz
			-120		Offset @100Hz
			-140		Offset @ 1k Hz
			-145		Offset @10 kHz
			-150		Offset @100kHz

*Note 1: For 10.000MHz carrier, frequency stability of ± 280 ppb is only guaranteed over -45°C to $+90^{\circ}\text{C}$ operating temperature range.

*Note 2: For 10.000MHz carrier, option "5" is not available.



7.0 x 5.0 x 1.9mm

AST3TQ

RoHS/RoHS II Compliant

OPTIONS & PART IDENTIFICATION: (left blank if standard)

AST3TQ - [] MHz - [] - []

Frequency in MHz
Please specify the frequency in MHz.
e.g. 19.200MHz

Freq. Stability vs. Operating Temp.
1: ± 100 ppb over -40 to $+85^{\circ}\text{C}$
2: ± 280 ppb over -50 to $+90^{\circ}\text{C}$ *
5: ± 500 ppb over -55 to $+95^{\circ}\text{C}$ **

Packaging
Blank: Bulk
T: 500pcs/reel
T2: 2000pcs/reel

* Note 1: For 10.000MHz carrier, frequency stability of ± 280 ppb is only guaranteed over -45°C to $+90^{\circ}\text{C}$ operating temperature range.

**Note 2: For 10.000MHz carrier, option "5" is not available.

FREQUENCY STABILITY VS. TEMPERATURE

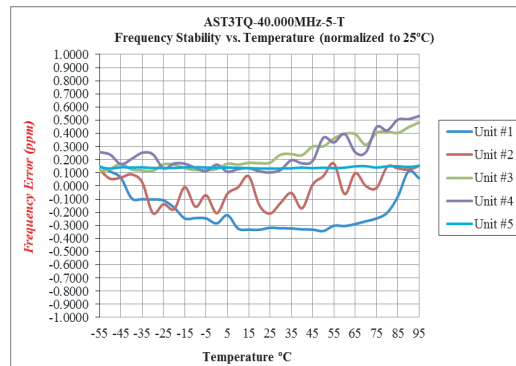
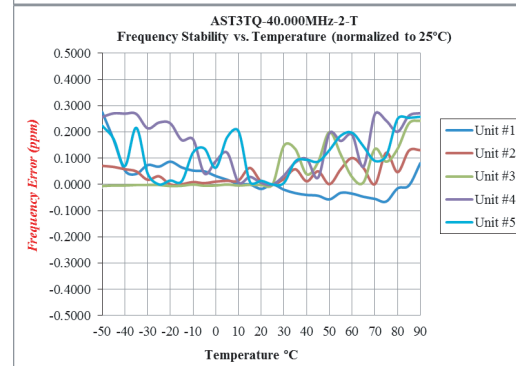
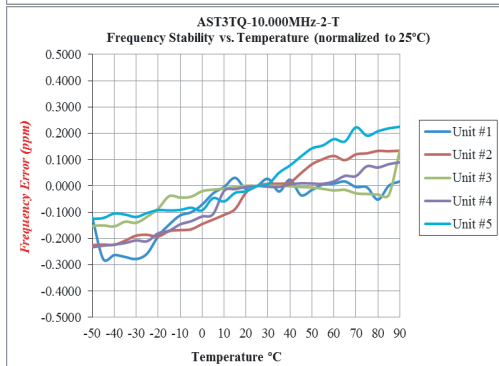
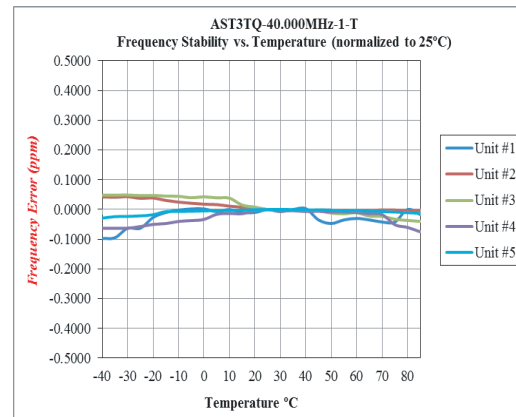
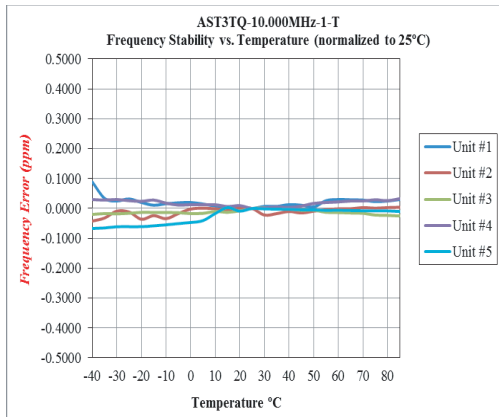



7.0 x 5.0 x 1.9mm

AST3TQ

Pb RoHS/RoHS II Compliant

TYPICAL PHASE NOISE

10.00 MHz Carrier

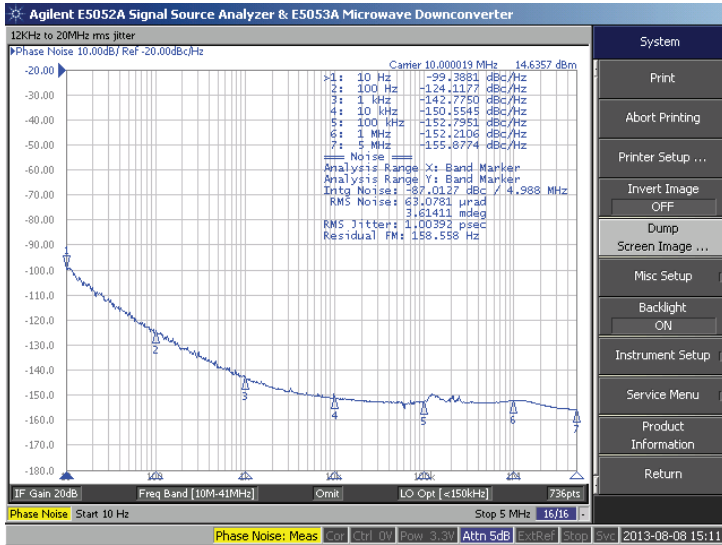

20.00 MHz Carrier

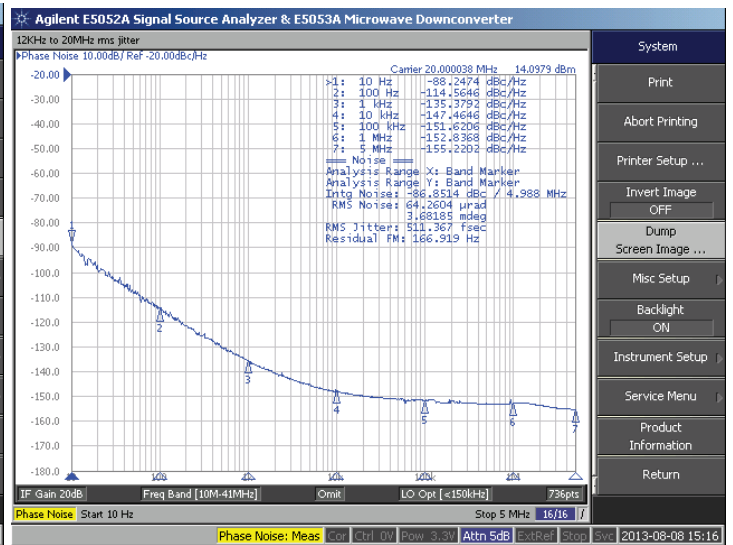

40.00 MHz Carrier

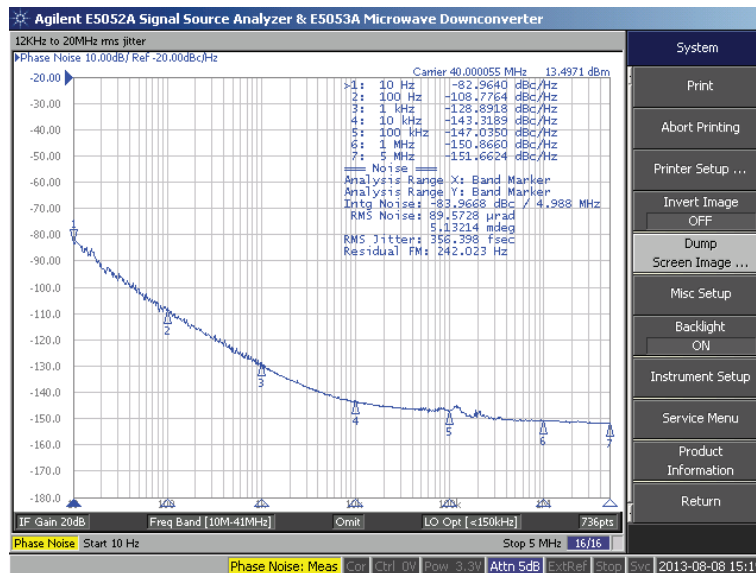



7.0 x 5.0 x 1.9mm

AST3TQ

RoHS/RoHS II Compliant

OUTLINE DIMENSION:

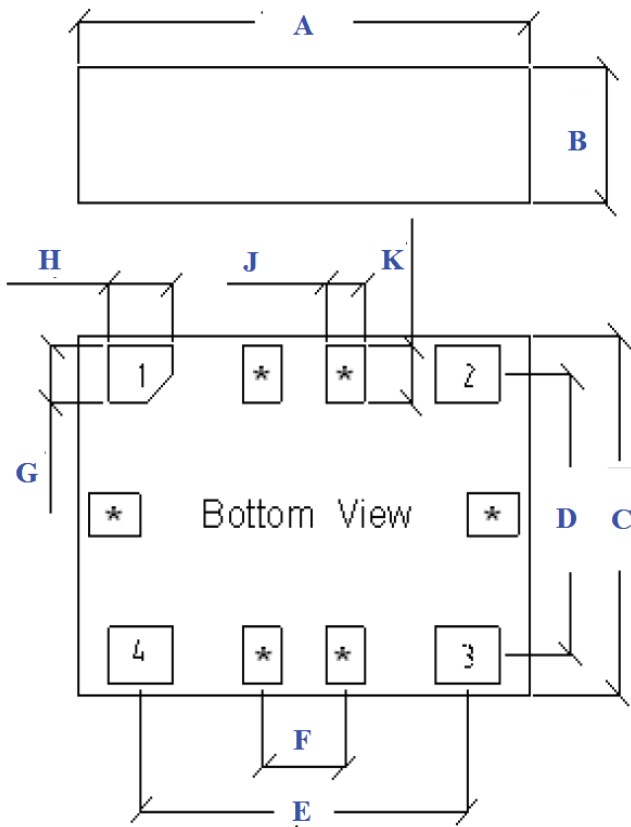

Letter	Dimension
A	7.1±0.2
B	1.9±0.2
C	5.0±0.2
D	3.90
E	5.08
F	1.27
G	1.00
H	1.50
J	0.60
K	1.00
M	3.90
N	5.08
P	4-1.2
Q	4-1.0

Recommended Land Pattern

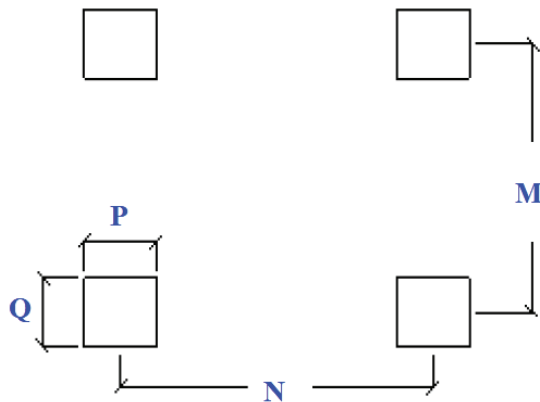

Pin	Function
1	NC
2	GND
3	Output
4	Vdd
*	For factory test only

Dimensions: mm



7.0 x 5.0 x 1.9mm

AST3TQ

RoHS/RoHS II Compliant

REFLOW PROFILE:

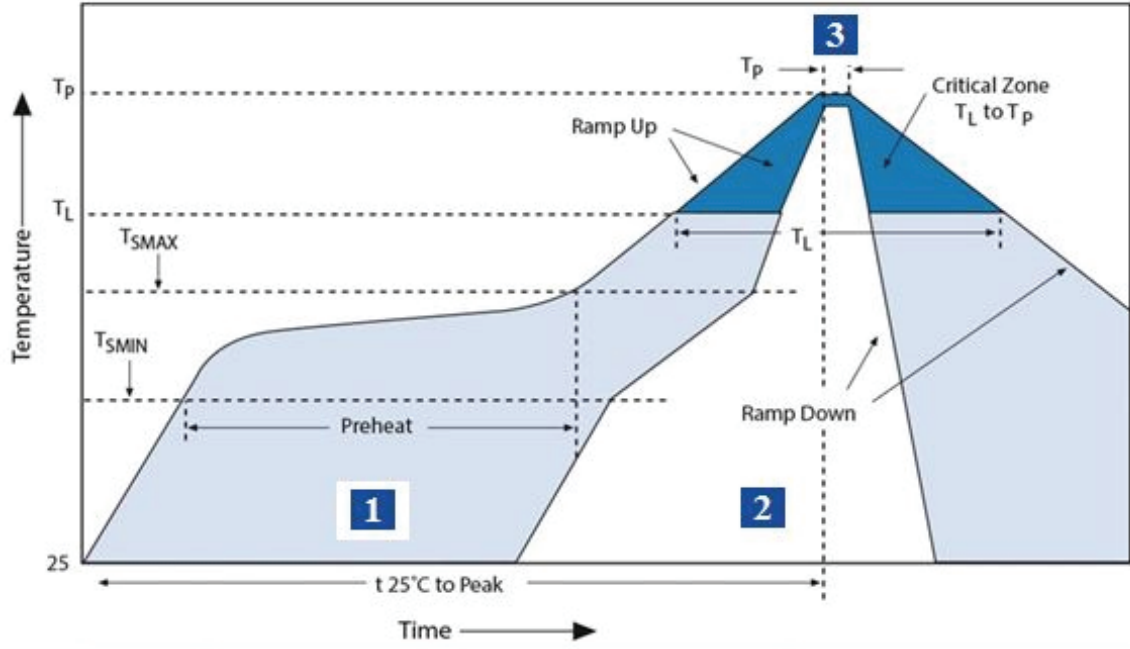

Zone	Description	Temperature	Times
1	Preheat	$T_{SMIN} \sim T_{SMAX}$ 150°C ~ 200°C	60 ~ 120 sec.
2	Reflow	T_L 220°C	60 ~ 150 sec.
3	Peak heat	T_P 260°C	25 sec. MAX



7.0 x 5.0 x 1.9mm

AST3TQ

RoHS/RoHS II Compliant

TAPE & REEL:

Packaging:

T: 500pcs/reel

T2: 2000pcs/reel

MSL-3 packaging applies to MOQ=25 units (cut tape) & T and T2.

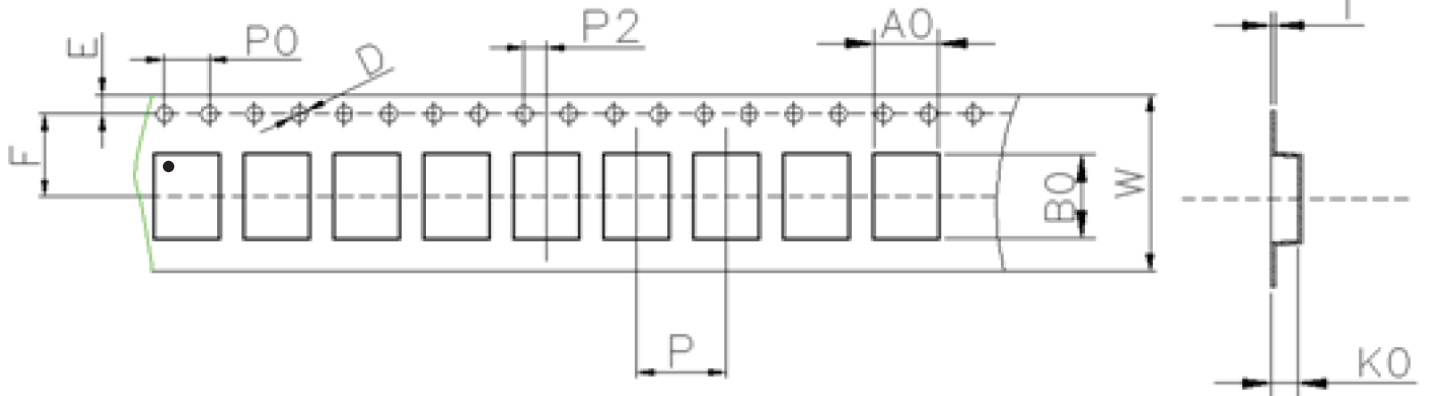

W	A0	B0	K0	P	F
16.0±0.3	5.7±0.15	7.6±0.15	2.4±0.15	8.0±0.1	7.5±0.1
E	D	P0	P2	T	
1.75±0.1	1.5+0.1/-0.0	4.0±0.1	2.0±0.1	0.3±0.05	

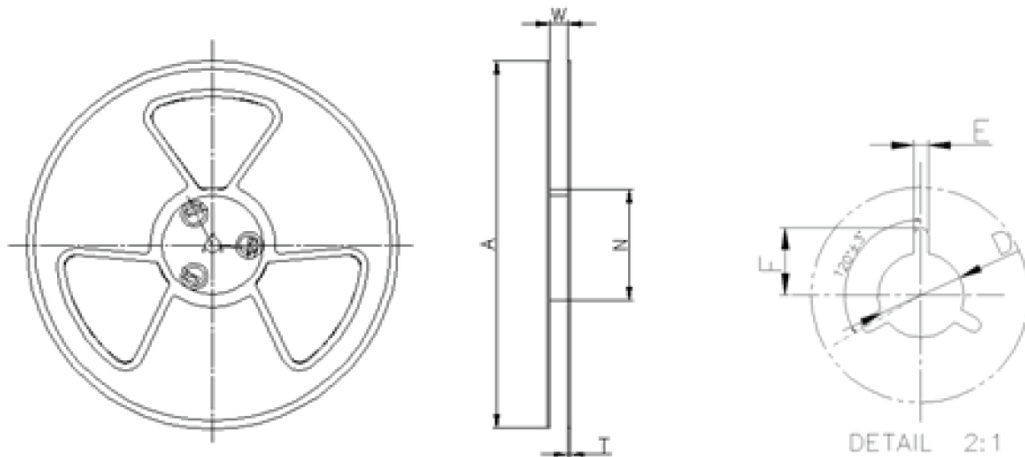

W	A	N	T	E	F	D
16.5±0.4	330±0.5	100±0.3	1.8±0.2	2.1±0.3	10.75±0.3	13.5+0.5/-0.2

Dimensions: mm

ATTENTION: Abracon LLC products are COTS – Commercial-Off-The-Shelf products; suitable for Commercial, Industrial and, where designated, Automotive Applications. Abracon's products are not specifically designed for Military, Aviation, Aerospace, Life-dependant Medical applications or any application requiring high reliability where component failure could result in loss of life and/or property. For applications requiring high reliability and/or presenting an extreme operating environment, written consent and authorization from Abracon LLC is required. Please contact Abracon LLC for more information.