

# Molding Type Power Inductor

ASPI-0630LR



RoHS  
Compliant



7.2 x 6.65 x 3.0 mm

## FEATURES:

- High saturation current.
- Low loss due to low DC resistance.
- Frequency application up to 3MHz.
- Low profile with max thickness 3.0mm.
- 100% lead free and metted RoHS standard.
- Suitable for reflow soldering.
- High reliable SMD package

## APPLICATIONS:

- DC/DC converters in Notebook, Netbook, desktop and server
- Low profile, high current power supplies.

## STANDARD SPECIFICATIONS

Abrakon P/N:	ASPI-0630LR Series
Operating Temperature & Humidity:	-55°C to +125°C (Including self generated heat)
Storage Temperature & Humidity:	+25°C to +35°C, 45% to 85% RH

Part Number	Inductance	Tolerance	DCR Typ	DCR Max	Saturation Current	Temperature Rise Current
Units	μH	%	mΩ	mΩ	A	A
Symbol	L	M			Isat	Irms
ASPI-0630LR-R47	0.47	M	3.5	4.1	20.0	18.0
ASPI-0630LR-R56	0.56	M	4.7	5.0	18.0	17.0
ASPI-0630LR-R68	0.68	M	6.0	6.5	17.0	16.0
ASPI-0630LR-R82	0.82	M	7.0	7.5	16.0	14.0
ASPI-0630LR-1R0	1.0	M	8.5	9.0	15.0	12.0
ASPI-0630LR-1R5	1.5	M	10.5	12.0	14.0	10.0
ASPI-0630LR-2R2	2.2	M	16.0	18.5	10.0	8.0
ASPI-0630LR-3R3	3.3	M	25.0	28.0	10.0	6.5
ASPI-0630LR-4R7	4.7	M	32.5	35.0	6.5	5.5
ASPI-0630LR-5R6	5.6	M	32.5	35.5	5.0	6.0
ASPI-0630LR-6R8	6.8	M	54.0	60.0	6.0	4.5
ASPI-0630LR-100	10.0	M	62.0	68.0	5.5	4.0
ASPI-0630LR-150	15.0	M	110.0	120.0	5.0	3.0
ASPI-0630LR-220	22.0	M	152.0	167.0	2.5	2.5

### Test Conditions

1. Inductance is measured in HP-4284A Precision LCR Meter.
2. RDC is measured in HP-4338B milli ohm meter.(or equivalent).
3. Isat: Based on inductance change ( $\Delta L/L_0 : \leq -30\%$ )
4. Irms: Based on temperature rise ( $\Delta T : 40^\circ\text{C TYP.}$  )

## ELECTRICAL CHARACTERISTIC CURVES

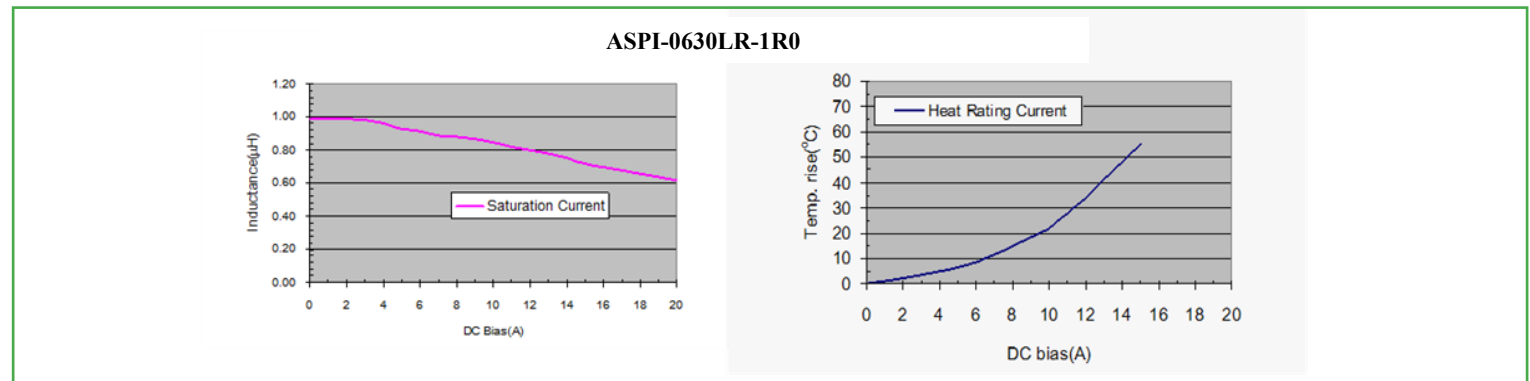

# Molding Type Power Inductor

ASPI-0630LR



RoHS  
Compliant



7.2 x 6.65 x 3.0 mm

## ELECTRICAL CHARACTERISTIC CURVES

ASPI-0630LR-1R5

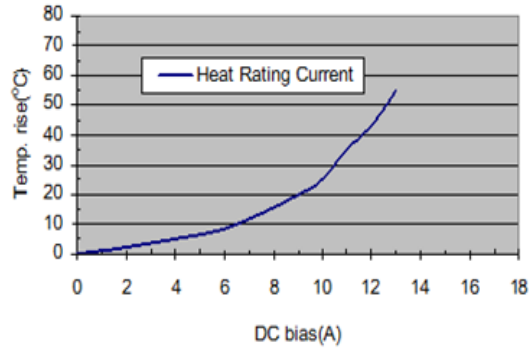
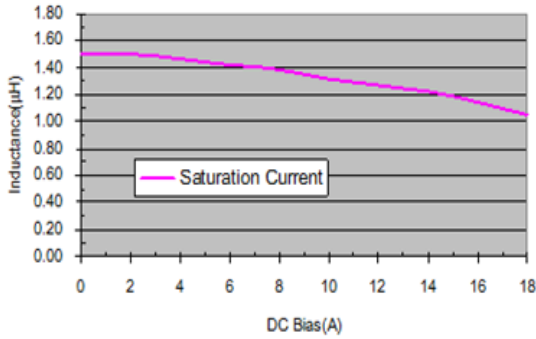

ASPI-0630LR-2R2

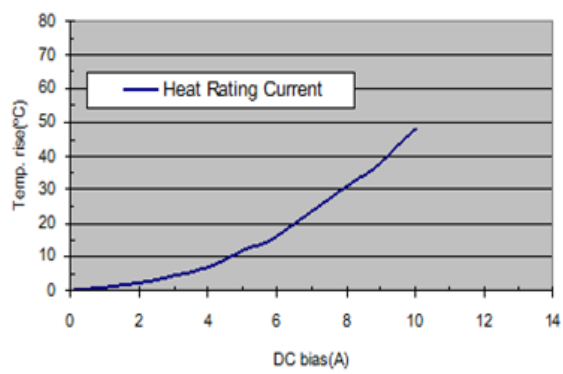
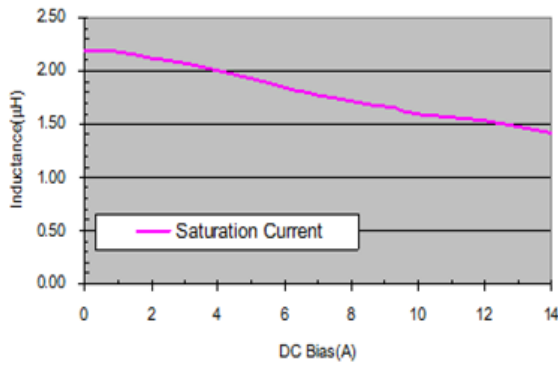

ASPI-0630LR-3R3

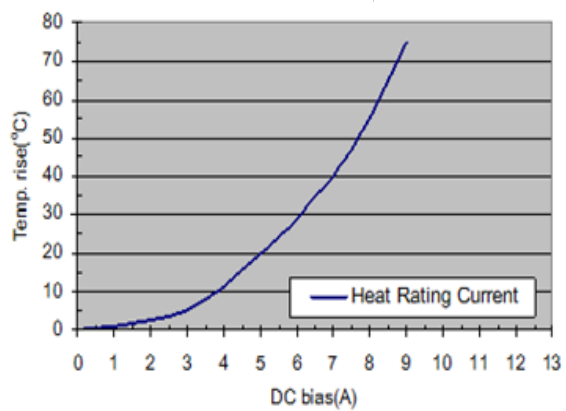
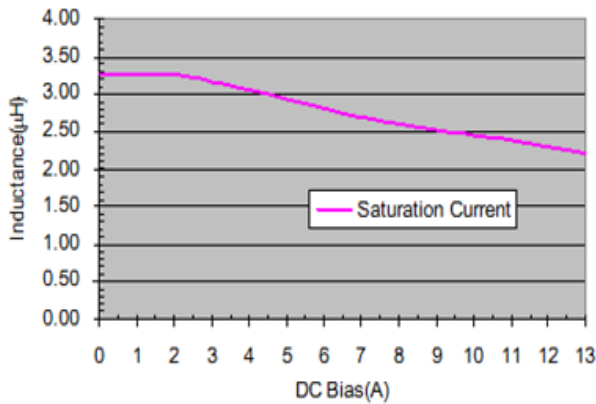

# Molding Type Power Inductor

ASPI-0630LR



7.2 x 6.65 x 3.0 mm

## ELECTRICAL CHARACTERISTIC CURVES

ASPI-0630LR-4R7

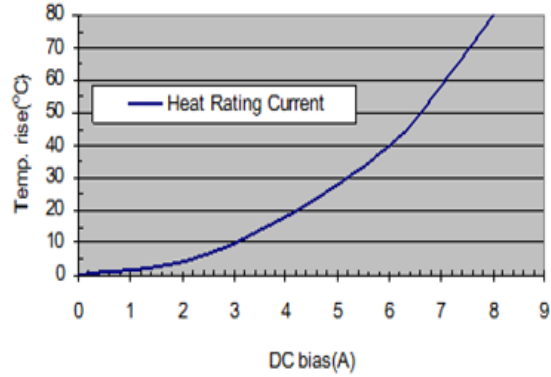
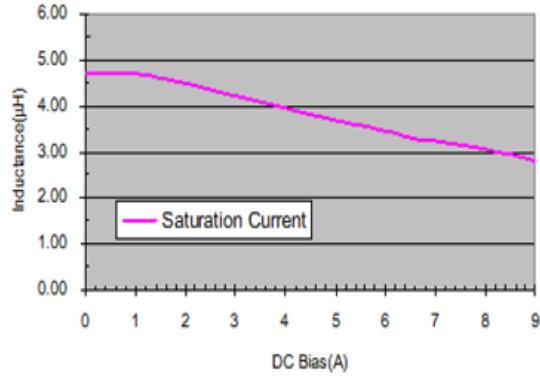

ASPI-0630LR-5R6

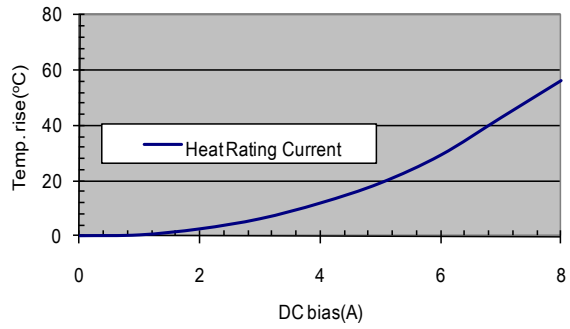
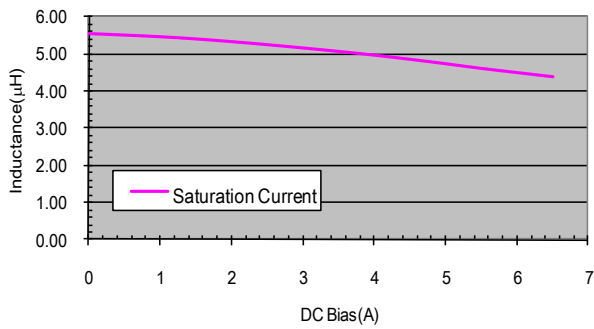

ASPI-0630LR-6R8

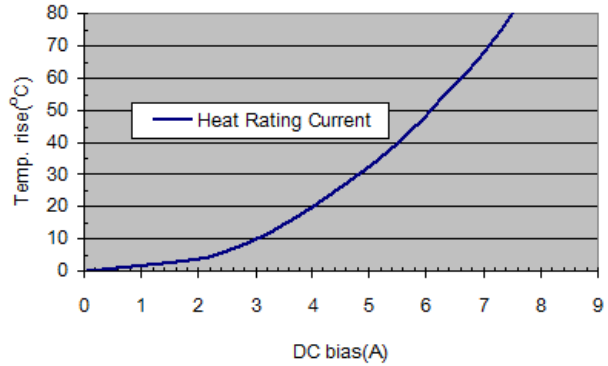
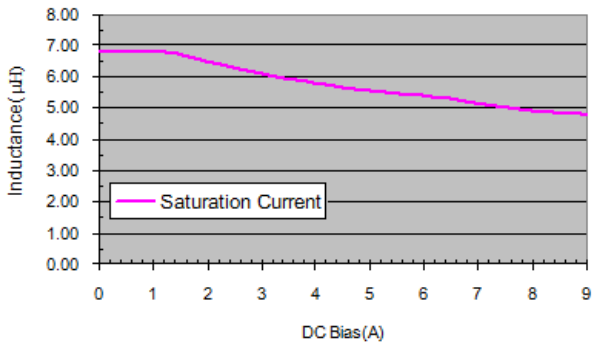

# Molding Type Power Inductor

ASPI-0630LR



7.2 x 6.65 x 3.0 mm

## ELECTRICAL CHARACTERISTIC CURVES

ASPI-0630LR-100

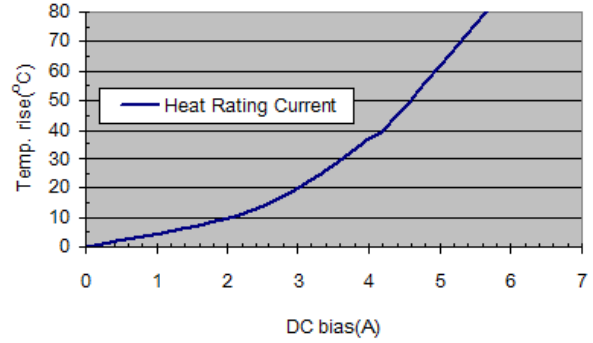
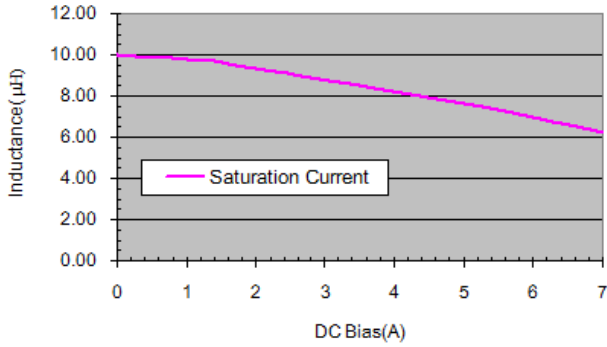

ASPI-0630LR-150

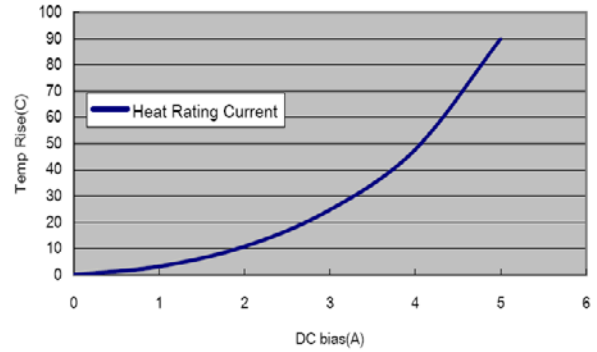
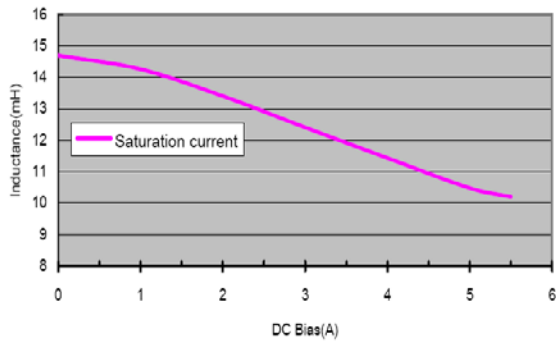

ASPI-0630LR-R47

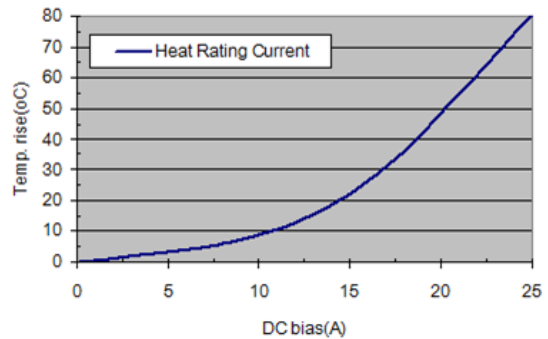
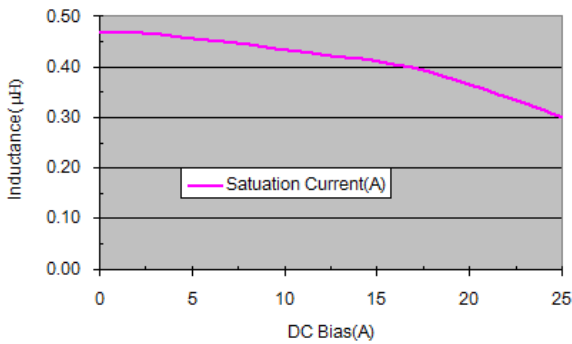

# Molding Type Power Inductor

ASPI-0630LR



RoHS  
Compliant



7.2 x 6.65 x 3.0 mm

## ELECTRICAL CHARACTERISTIC CURVES

ASPI-0630LR-R56

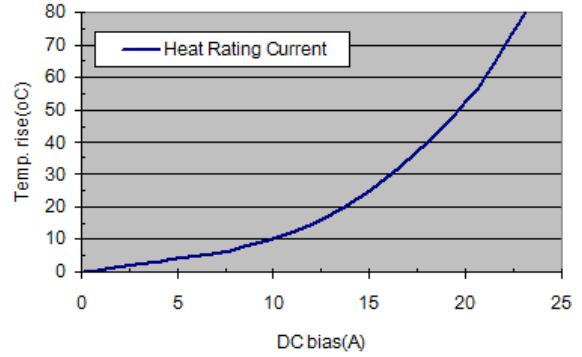
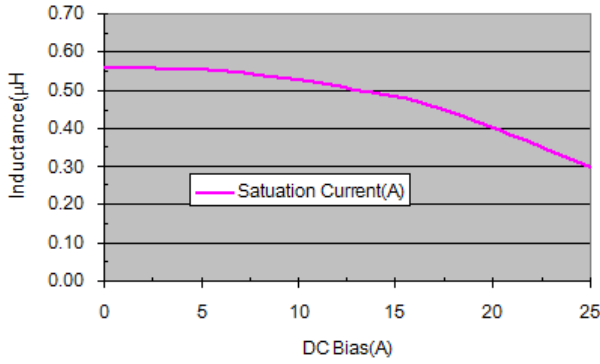

ASPI-0630LR-R68

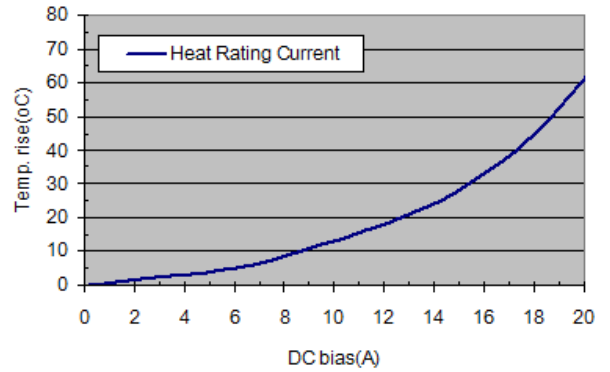
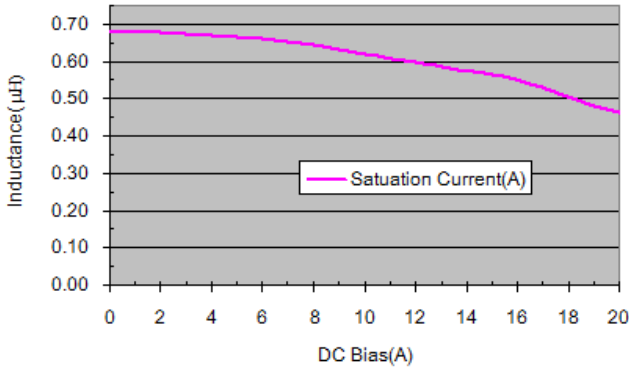

ASPI-0630LR-R82

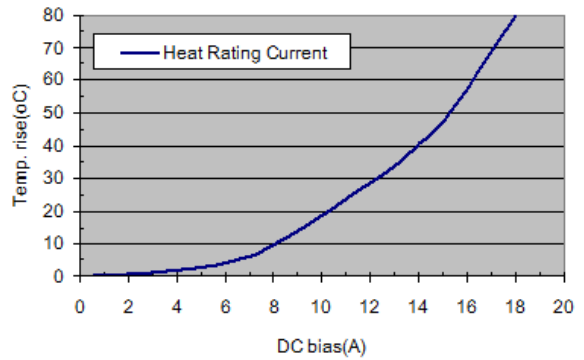
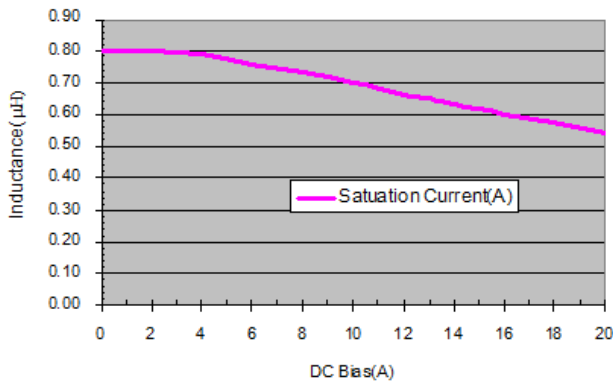

# Molding Type Power Inductor

ASPI-0630LR



7.2 x 6.65 x 3.0 mm

## PART NUMBER IDENTIFICATION

ASPI-0630LR---

<b>Inductance Code</b> Please refer to the Electrical Spec Table	<b>Tolerance</b> M: $\pm 20\%$	<b>Packaging</b> T15: Tape and Reel (1.5kpcs / reel)
---	-----------------------------------	---

## OUTLINE DRAWING:

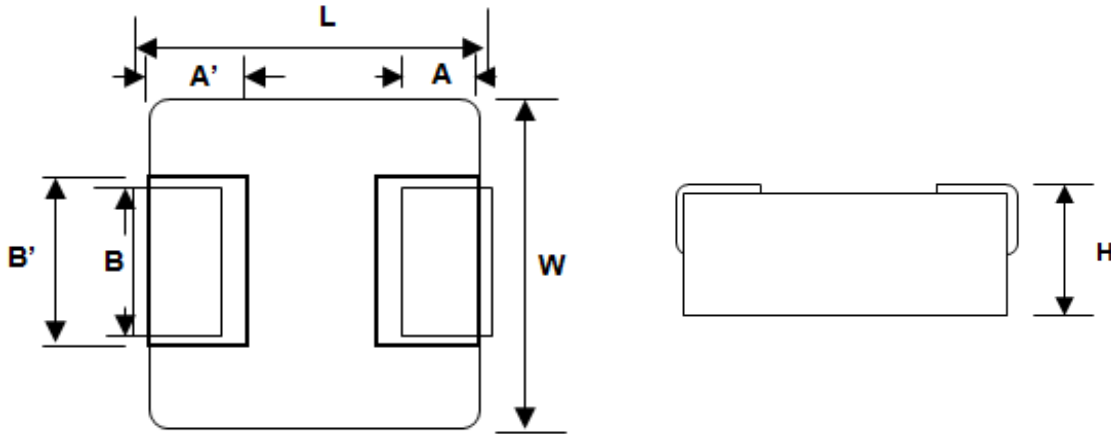

A	A'	B	B'	L	W	H max
1.6 $\pm 0.4$	2.0 $\pm 0.1$	3.0 $\pm 0.3$	3.4 $\pm 0.2$	7.2 $\pm 0.3$	6.65 $\pm 0.2$	3.0

### Recommended Land Pattern

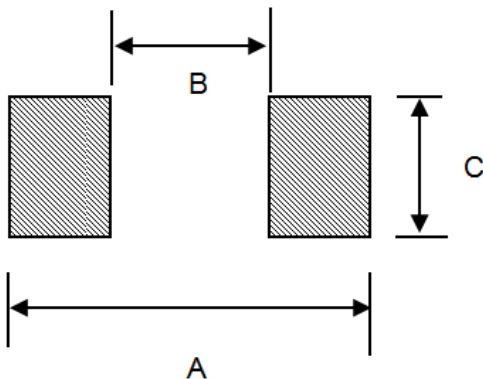

A	B	C
8.4	3.7	3.4

Dimension: mm

# Molding Type Power Inductor

ASPI-0630LR



RoHS  
Compliant



7.2 x 6.65 x 3.0 mm

## TAPE & REEL:

T1: 1,500pcs / reel

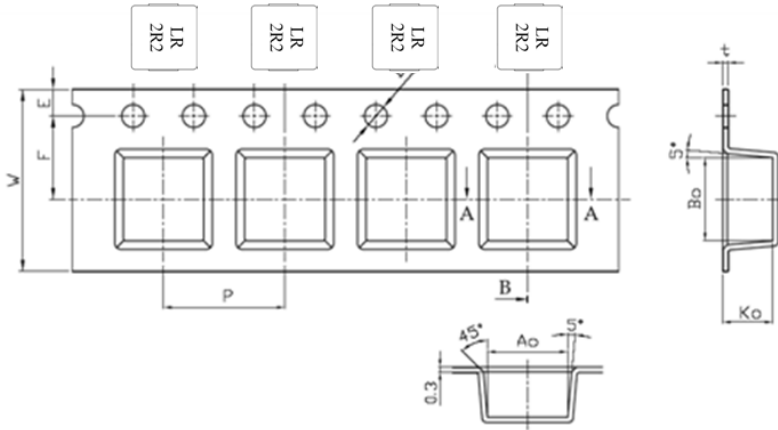

A0	7.2
B0	7.5
K0	3.6
P	12.0
t	0.3
W	16
E	1.75
F	7.5
D	1.5

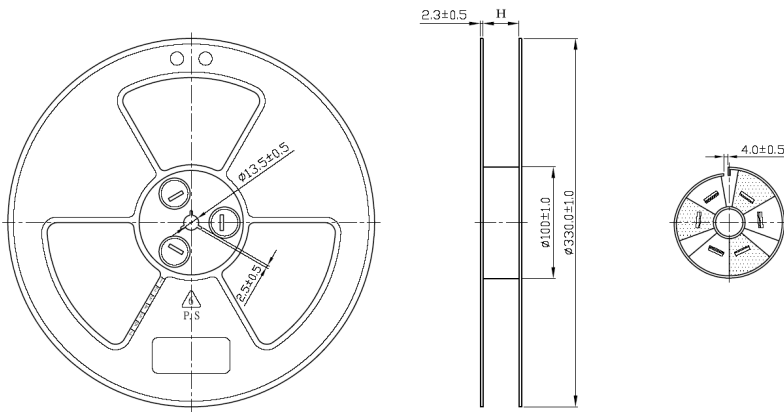

Dimension: mm

# Molding Type Power Inductor

ASPI-0630LR



RoHS  
Compliant



7.2 x 6.65 x 3.0 mm

## REFLOW PROFILE:

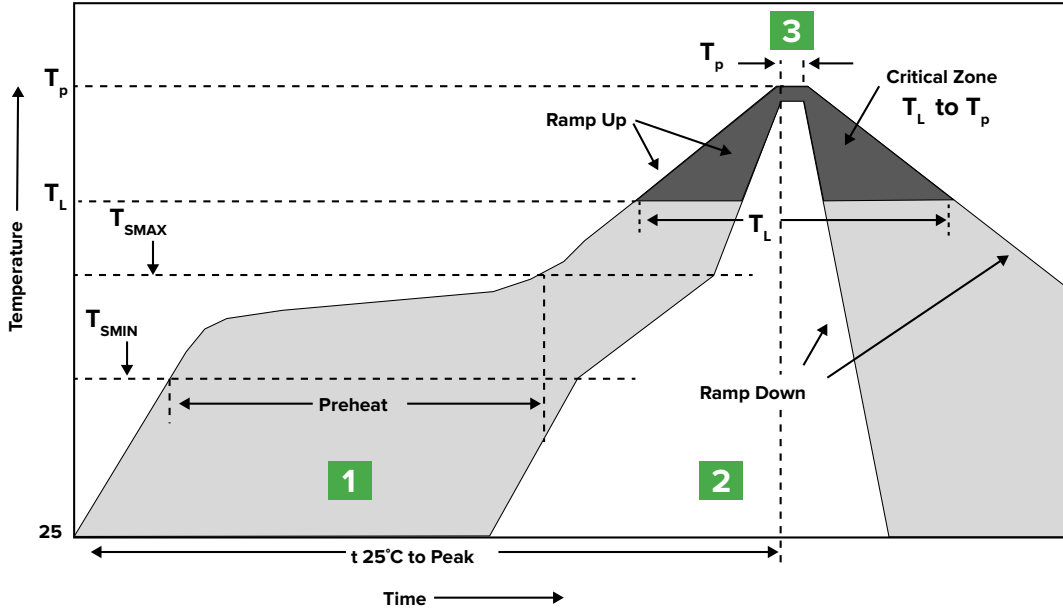

Zone	Description	Temperature	Times
1	Preheat	$T_{SMIN}$ to $T_{SMAX}$ 150°C to 200°C	60 to 120 sec.
2	Reflow	$T_L$ 217°C	60 to 150 sec.
3	Peak heat	$T_P$ 260°C	30 sec. MAX

**ATTENTION:** Abracon LLC's products are COTS – Commercial-Off-The-Shelf products; suitable for Commercial, Industrial and, where designated, Automotive Applications. Abracon's products are not specifically designed for Military, Aviation, Aerospace, Life-dependant Medical applications or any application requiring high reliability where component failure could result in loss of life and/or property. For applications requiring high reliability and/or presenting an extreme operating environment, written consent and authorization from Abracon LLC is required. Please contact Abracon LLC for more information.