

SMT Air Coil Inductor

AIAC-1008C

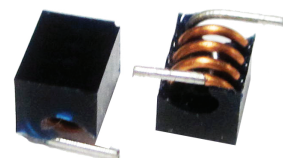

RoHS
Compliant



3.20 x 1.90 x 2.20mm

FEATURES:

- High current design
- Wide Range Frequency Response
- Excellent Q & SRF
- Standard flat cap top suitable for automatic placement.

APPLICATIONS:

- Widely used in Cordless Phones, High Frequency Communication Equipments, Intercom, CATV,RFID
- Suitable for metal sensors and proximity sensors
- Noise suppression for RF power supply/bias
- I/O filtering, frequency selection for audio devices such as Loudspeakers,Hifi
- Impedance Matching for transceivers
- Improves switch isolation for RF circuit

STANDARD SPECIFICATIONS:

ABRACON P/N:	AIAC-1008C
Operating temperature:	-40 °C ~ +125 °C
Storage temperature:	-25°C to + 60°C

Part Number	Inductance	Tolerance	DCR (Max)	Q(Min)	SRF(Min)	Rated Current (Max)	Inductance Code
Units	nH	%	mΩ		MHz	mA	
Symbol	L	K	DCR			IDC	
AIAC-1008C-6N8	6.8	K	4.0	80	>3000	1200	6N8
AIAC-1008C-8N2	8.2	K	5.0	80	>3000	950	8N2
AIAC-1008C-10N	10	K	6.0	70	>3000	950	10N
AIAC-1008C-12N	12	K	6.5	70	>3000	900	12N
AIAC-1008C-15N	15	K	7.3	70	2500	900	15N
AIAC-1008C-18N	18	K	9.6	70	2500	840	18N
AIAC-1008C-22N	22	K	10.8	70	2400	840	22N
AIAC-1008C-27N	27	K	13.9	70	1600	600	27N
AIAC-1008C-33N	33	K	19.5	70	1600	500	33N
AIAC-1008C-39N	39	K	21.6	70	1500	500	39N

Test Conditions and equipments

Test frequency: 300MHz

Equipment: HP4286A/HP16191A

PART IDENTIFICATION:

AIAC-1008C- [] [] - []

Inductance Code
Please refer to the Electrical Spec Table

Tolerance
K: ±10%

Packaging
T: Tape and Reel (3kpcs / reel)

SMT Air Coil Inductor

AIAC-1008C



RoHS
Compliant

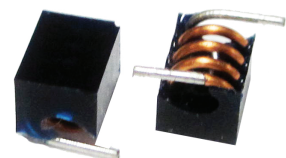

3.20 x 1.90 x 2.20mm

OUTLINE DRAWING:

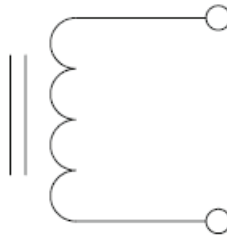
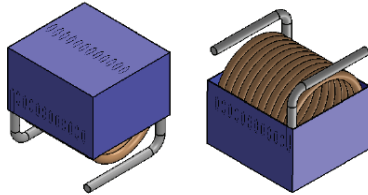
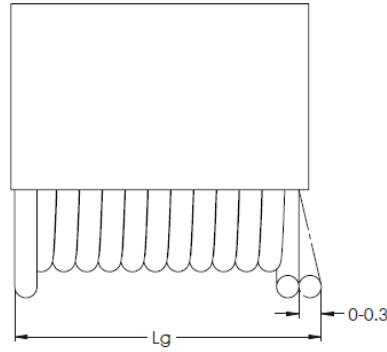
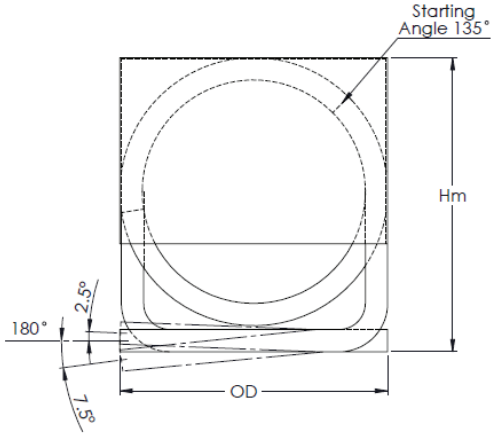

Hm	2.20 Max
OD	1.90 Max
Lg	3.20 Max

Recommended Land Pattern

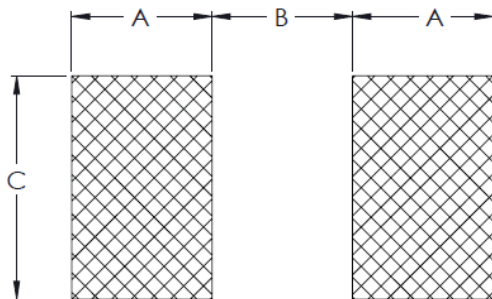

A	1.02 Min
B	1.27 Min
C	2.54 Min

Dimension: mm

SMT Air Coil Inductor

AIAC-1008C



RoHS
Compliant

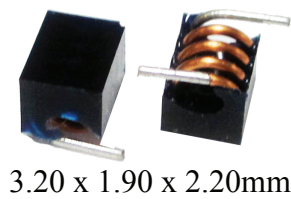

3.20 x 1.90 x 2.20mm

REFLOW PROFILE:

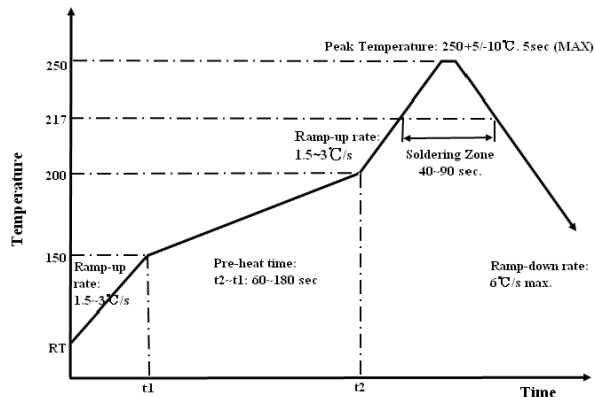

TAPE & REEL:

Packing

T: 3,000pcs / reel

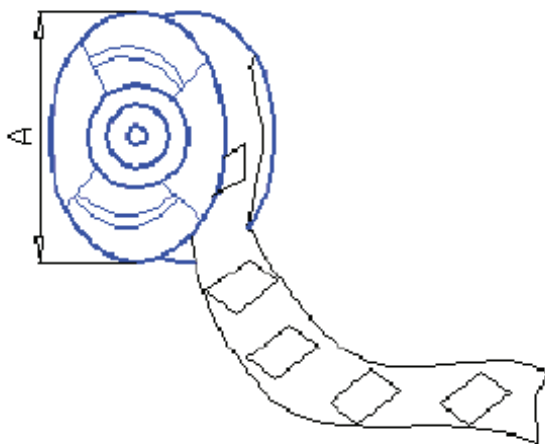
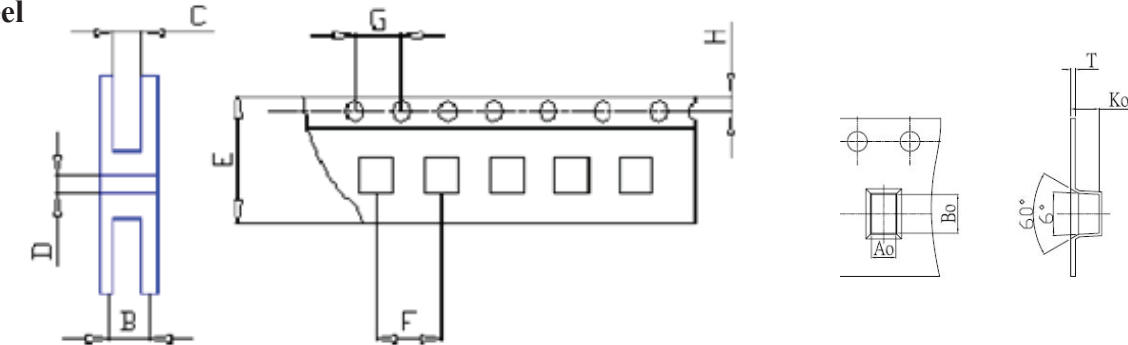

Ao	2.3±0.10
Bo	3.4±0.10
Ko	2.3±0.10
A	330
B	18
C	12
D	13
E	12
F	8.0
G	4.0
H	1.75
T	0.35

Dimension: mm

ATTENTION: Abracon Corporation's products are COTS – Commercial-Off-The-Shelf products; suitable for Commercial, Industrial and, where designated, Automotive Applications. Abracon's products are not specifically designed for Military, Aviation, Aerospace, Life-dependant Medical applications or any application requiring high reliability where component failure could result in loss of life and/or property. For applications requiring high reliability and/or presenting an extreme operating environment, written consent and authorization from Abracon Corporation is required. Please contact Abracon Corporation for more information.