

## 2.5A, 3MHz Switching Charger with Dynamic Power Path Management

### DESCRIPTION

ETA6003 is a switching Li-Ion battery charger with dynamic power-path control and input current limiting. When a battery is connected, depending on the battery voltage, the DC-DC switching regulator either pre-conditions, fast-charges the battery or just regulates a system voltage ( $V_{SYS}$ ) to a preset voltage. It does not require an external sense resistor for current sensing. The charging current is determined by programming ISET1 or ISET2 pin, depending on the state of the USB\_DET. If USB\_DET is low, indicating a valid AC adapter input is present, the charge current is set by ISET1; otherwise, it is set by ISET2. When the battery voltage reaches the termination voltage i.e., 4.2V, the charging path disconnects SYS to BATT. The ETA6003 also includes a dynamic power path when the SYS load current exceeds current limit of the DCDC regulator internally set, the SYS voltage falls below  $V_{BATT}$ , ETA6003 turns on the power-path to supplement the system load through the battery.

### FEATURES

- ◆ Switching Charger with Power Path Management
- ◆ Up to 95% DC-DC Efficiency
- ◆ 50mΩ Power Path MOSFET
- ◆ Up to 2.5A Max charging current
- ◆ Instant on with a dead Battery or no Battery
- ◆ No battery detection
- ◆ No External Sense resistor
- ◆ Programmable USB and AC IN Charging Current
- ◆ RoHS Compliant

### APPLICATIONS

- ◆ Tablet, MID
- ◆ Smart Phone
- ◆ Power Bank

### ORDERING INFORMATION

| PART No.   | PACKAGE   | TOP MARK         | Pcs/Reel |
|------------|-----------|------------------|----------|
| ETA6003Q3Q | QFN3X3-16 | ETA6003<br>YWWPL | 5000     |

## TYPICAL APPLICATION

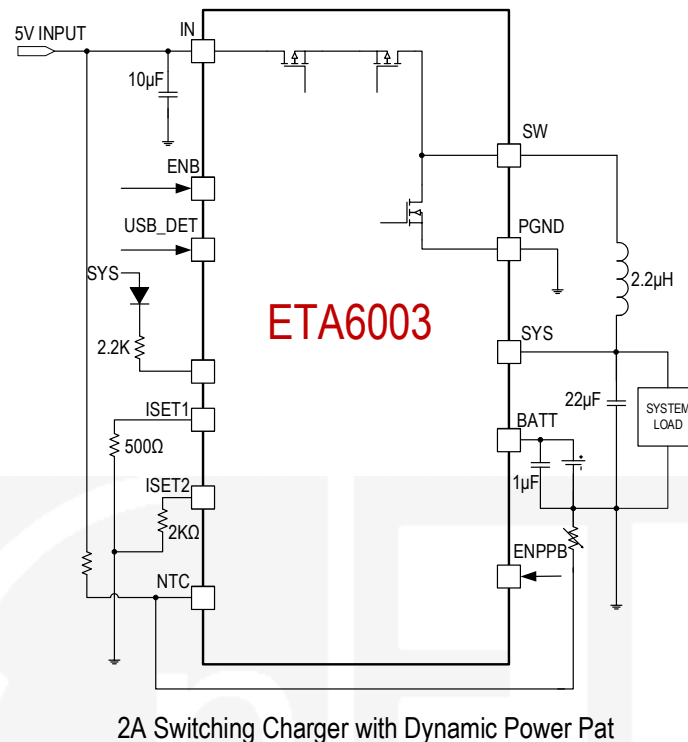

## PIN CONFIGURATION

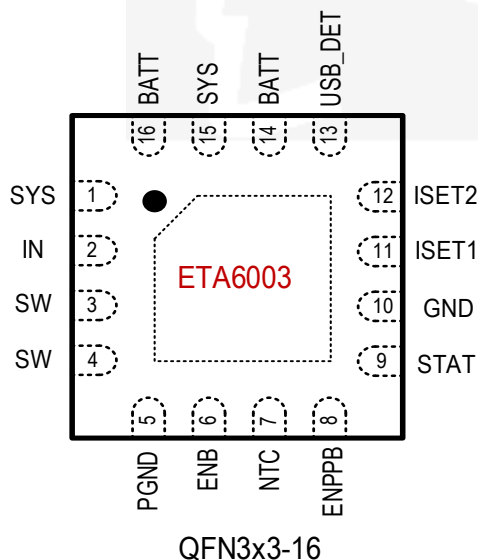

## ABSOLUTE MAXIMUM RATINGS

(Note: Exceeding these limits may damage the device. Exposure to absolute maximum rating conditions for long periods may affect device reliability.)

|                                       |                      |
|---------------------------------------|----------------------|
| IN, BATT Voltage .....                | -0.3V to 6V          |
| All Other Pin Voltage .....           | VIN-0.3V to VIN+0.3V |
| SW, SYS, BATT to ground current ..... | Internally limited   |
| Operating Temperature Range .....     | -40°C to 85°C        |
| Storage Temperature Range .....       | -55°C to 150°C       |
| Thermal Resistance                    | $\theta_{JA}$        |
| QFN3x3-16 .....                       | 50 °C/W              |

## ELECTRICAL CHARACTERISTICS

( $V_{IN} = 5V$ , unless otherwise specified. Typical values are at  $TA = 25^{\circ}C$ .)

| PARAMETER                     | CONDITIONS   | MIN  | TYP  | MAX  | UNITS       |
|-------------------------------|--|------|------|------|-------------|
| <b>IN INPUT</b>               |  |      |      |      |             |
| INPUT Range                   |  | 4.4  |      | 5.5  | V           |
| INPUT UVLO                    | Rising, Hys=500mV  |      | 3.9  |      | V           |
| INPUT Operating Current       | Switcher Enable, Switching   |      | 5    |      | mA          |
|                               | Switcher Enable, No Switching  |      | 70   |      | $\mu A$     |
| BATT to INPUT leakage Current | Input Floating   |      | 0    | 5    | $\mu A$     |
| Vhold                         | When $V_{IN}$ drop to Vhold, then reduce DC-DC current limit                   |      | 4.5  |      | V           |
| <b>DC-DC and SYS OUTPUT</b>   |  |      |      |      |             |
| VSYSMIN                       | $I_{SYS}=1A$ , Default   |      | 3.6  |      | V           |
| VSYSMAX                       |  |      | 4.5  |      | V           |
| Load Regulation               |  |      | 40   |      | mV/A        |
| Line Regulation               | $V_{IN} = 4.75$ to $5.25V$   |      | 0.04 |      | %/V         |
| Switching Frequency           |  |      | 3    |      | MHz         |
| Max duty                      |  | 100  |      |      | %           |
| HIGH SIDE MOS RDSON           | $I_{SW} = 500mA$   |      | 100  |      | m $\Omega$  |
| LOW SIDE MOS RDSON            | $I_{SW} = 500mA$   |      | 60   |      | m $\Omega$  |
| HIGH SIDE Current limit       |  |      | 3.5  |      | A           |
| SYS UVLO                      | Falling, Hys=200mV   |      | 2.25 |      | V           |
| Thermal Shutdown              | Rising, Hys=30 $^{\circ}C$   |      | 160  |      | $^{\circ}C$ |
| <b>POWER PATH Management</b>  |  |      |      |      |             |
| BATT TO SYS RDSON             |  |      | 50   |      | m $\Omega$  |
| <b>BATTERY CHARGER</b>        |  |      |      |      |             |
| Battery CV voltage            | $I_{BAT} = 0mA$ , default  | 4.16 | 4.2  | 4.24 | V           |
| Charger Restart Threshold     | From DONE to FastCharge  |      | -150 |      | mV          |
| Battery Pre-condition Voltage | $V_{BAT}$ Rising Hys=180mV   |      | 2.9  |      | V           |
| Pre-Condition Charge Current  |  |      | 100  |      | mA          |
| AC Fast Charge Current        | $R_{ISET1} = 500\Omega$ , USB_DET= low<br>$I_{charge} = 1V * 1000 / R_{ISET1}$ |      | 2    |      | A           |
| USB Charge Current            | $R_{ISET2} = 2K\Omega$ , USB_DET= high<br>$I_{charge} = 1V * 1000 / R_{ISET2}$ |      | 0.5  |      | A           |
| Pre-condition Timer           |  |      | 120  |      | min         |
| Fast-Charge Timer             |  |      | 960  |      | min         |
| EOC current                   | Percent of the fast charge current   |      | 10%  |      |             |
| <b>THERMISTOR MONITOR</b>     |  |      |      |      |             |
| NTC Threshold, Cold           | Charger Suspended  |      | 76.5 |      | % $V_{IN}$  |
| NTC Threshold, Hot            | Charger Suspended  |      | 35   |      | % $V_{IN}$  |

| PARAMETER                   | CONDITIONS               | MIN | TYP | MAX | UNITS            |
|-----------------------------|--------------------------|-----|-----|-----|------------------|
| NTC Threshold Hysteresis    |                          |     | 1.5 |     | %V <sub>IN</sub> |
| NTC Disable Threshold       |                          |     | 100 |     | mV               |
| NTC Input Leakage           |                          |     | 0   |     | μA               |
| <b>LOGIC INPUT, STATS</b>   |                          |     |     |     |                  |
| ENB, ENPPB Logic Input High |                          | 1.6 |     |     | V                |
| ENB, ENPPB Logic Input Low  |                          |     |     | 0.3 | V                |
| STAT Output Low Voltage     | I <sub>STATS</sub> =10mA |     |     | 0.2 | V                |

## PIN DESCRIPTION

| PIN # | NAME    | DESCRIPTION   |
|-------|---------|---|
| 1,15  | SYS     | System Voltage Pin. It is also the Switching regulator's output pin. Connect an inductor and capacitor to form the output filter  |
| 2     | IN      | Input pin. Can be connected to an AC adaptor or a USB charger output. Bypass with a 10μF capacitor each to GND and PGND   |
| 3,4   | SW      | Switching node of the Switching Regulator. Connect a 1μH to 2.2μH inductor from this pin to SYS   |
| 5     | PGND    | Power Ground. Bypass with a 10μF capacitor to IN with a shortest possible trace   |
| 6     | ENB     | Active Low Enable pin. Tie this pin low to enable the Charging, tie high to disable Charging, while still keeping powerpath from BATT to SYS  |
| 7     | NTC     | Thermistor input  |
| 8     | ENPPB   | Shipping mode enable Pin. Tie to GND to enable power path from BATT to SYS, tie to BATT, to disable this path thereby enabling shipping mode to save power to extend battery life.  |
| 9     | STATS   | Status pin for Charging status indications. An open drain device capable of driving 10mA current  |
| 10    | GND     | Analog Ground Pin. Bypass with a 10μF capacitor to IN   |
| 11    | ISET1   | AC Fast Charge Current set pin for AC input. Connecting a Resistor between ISET1 to GND This sets the fast charge current value for AC adapter when USB_DET is low.   |
| 12    | ISET2   | USB Charge Current set pin for USB input. Connecting a Resistor between ISET2 to GND This sets the charge current value for USB input when USB_DET is high.   |
| 13    | USB_DET | Charge current selecting input. Pull this pin low if an AC adapter is connected and select fast charging current to be set by ISET1. And set this pin high if a USB input is connected and select USB charging current to be set by ISET2. It is default low. |
| 14,16 | BATT    | Battery pin. Connect a Battery to this pin  |

## TYPICAL CHARACTERISTICS

(Typical values are at  $T_A = 25^\circ\text{C}$  unless otherwise specified.)

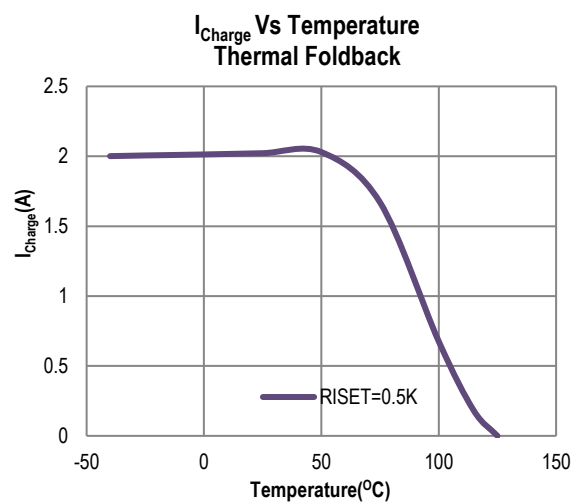
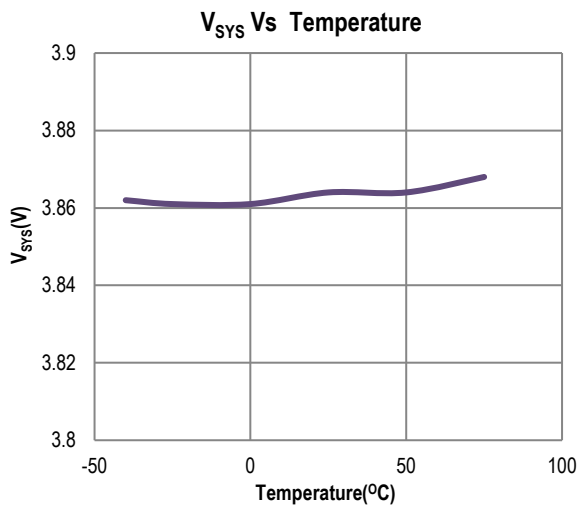
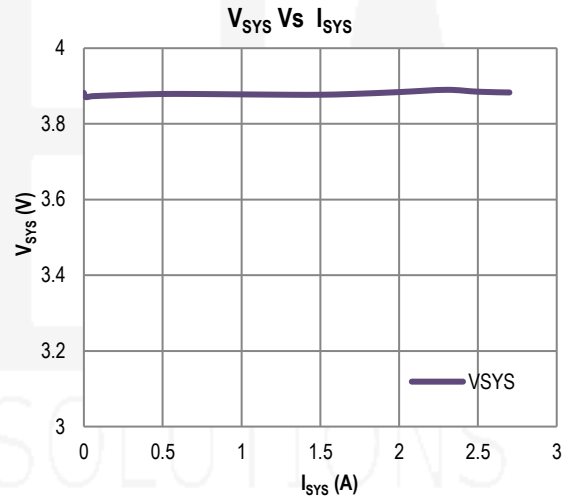
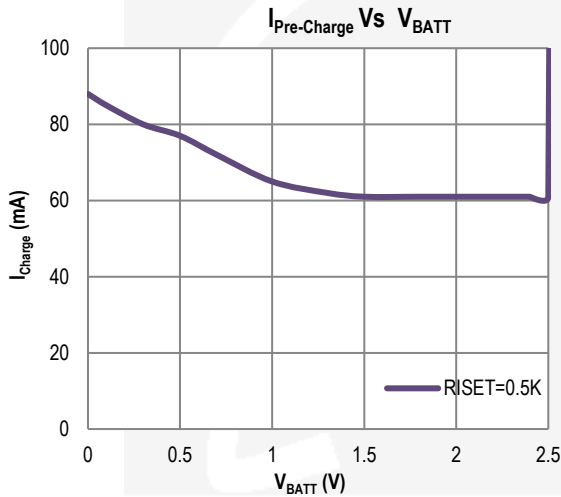
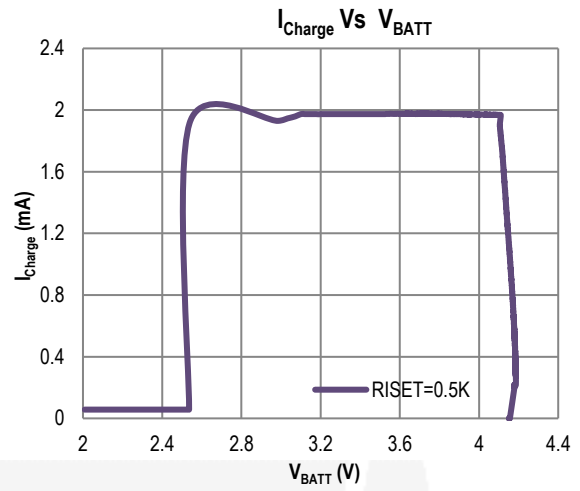
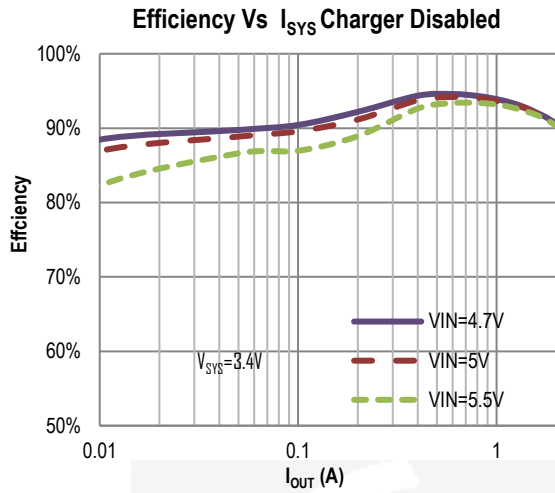

## TYPICAL CHARACTERISTICS cont'd

(Typical values are at  $T_A = 25^\circ\text{C}$  unless otherwise specified.)

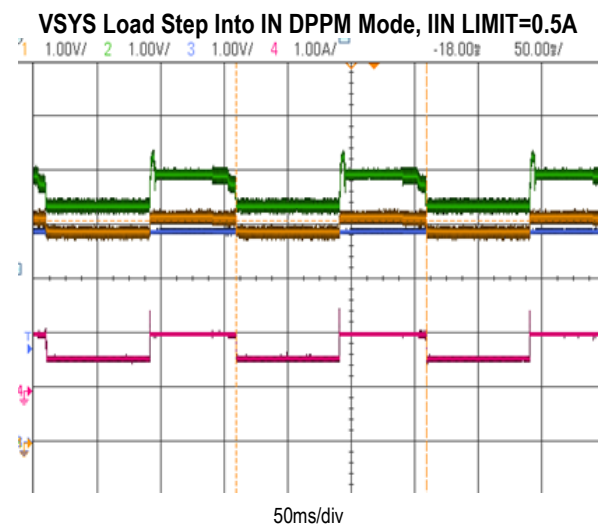
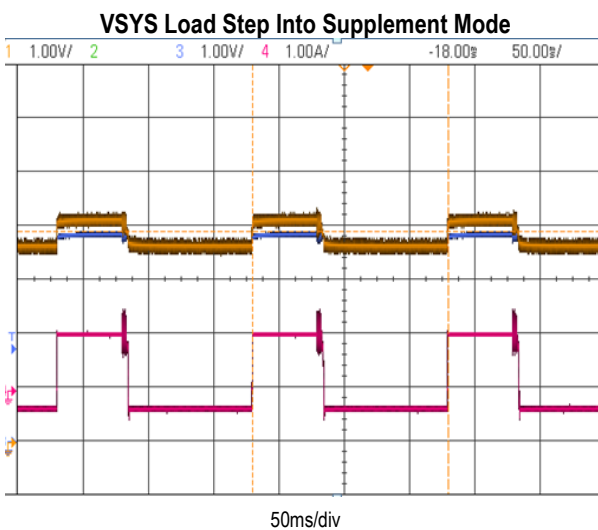
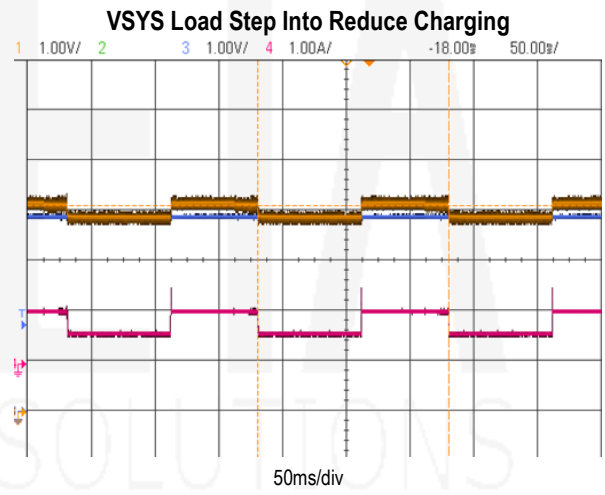
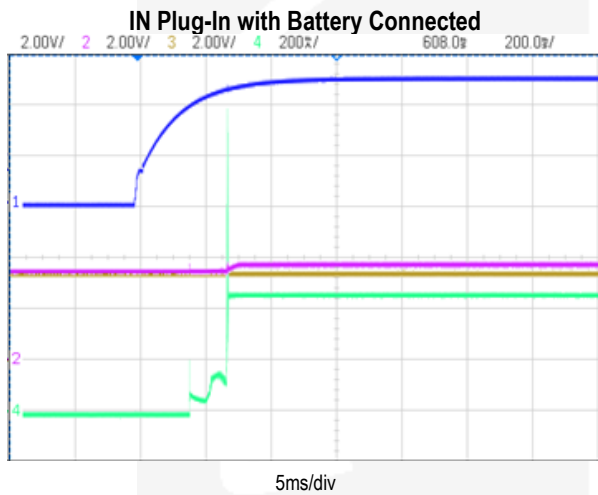
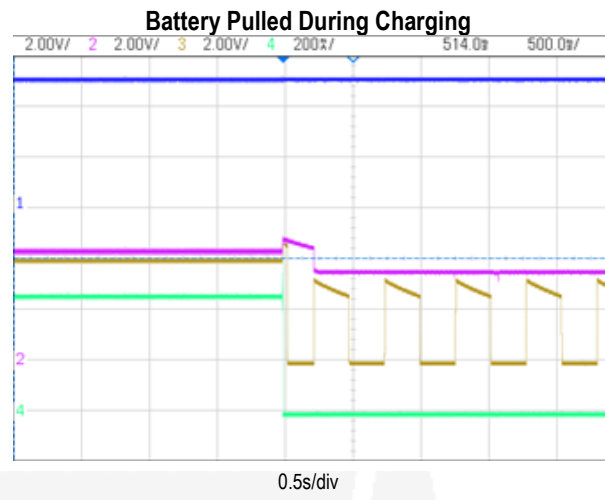
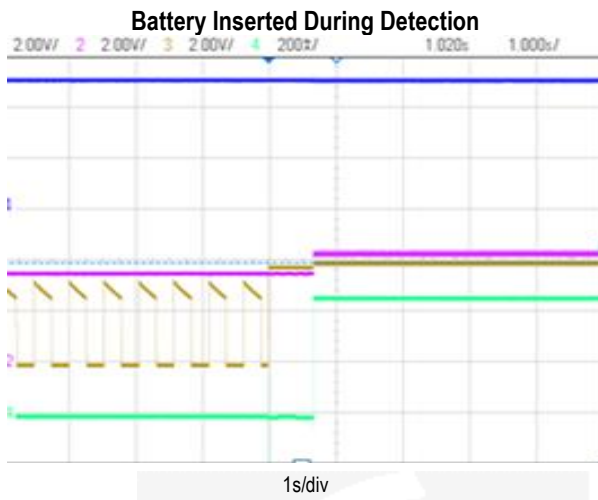

### TYPICAL CHARACTERISTICS cont'd

(Typical values are at  $T_A = 25^\circ\text{C}$  unless otherwise specified.)

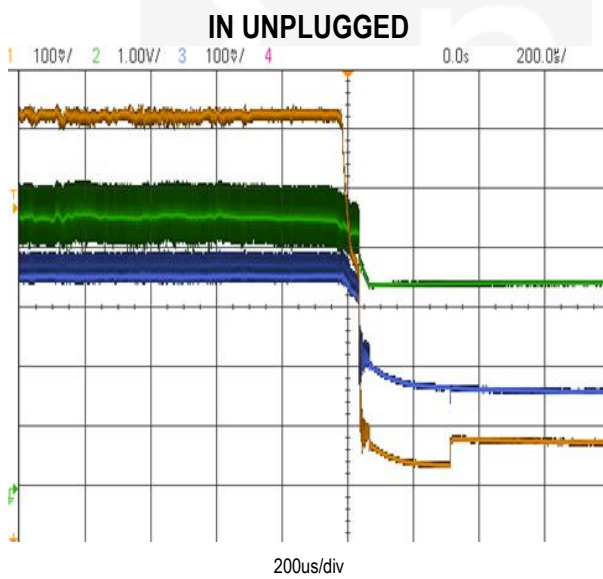
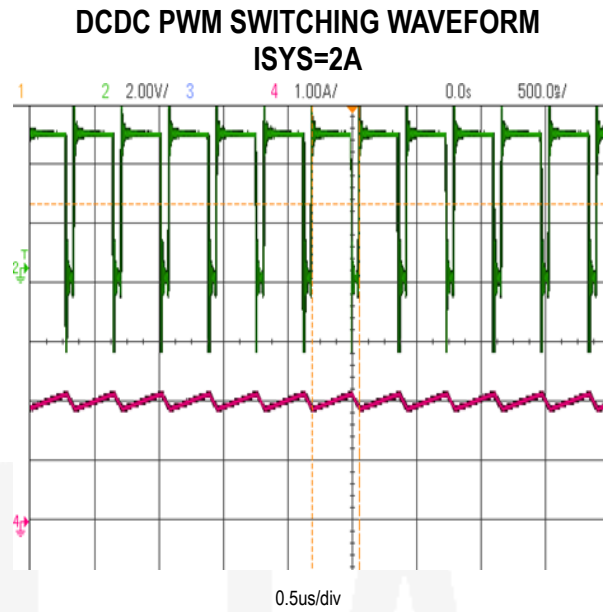
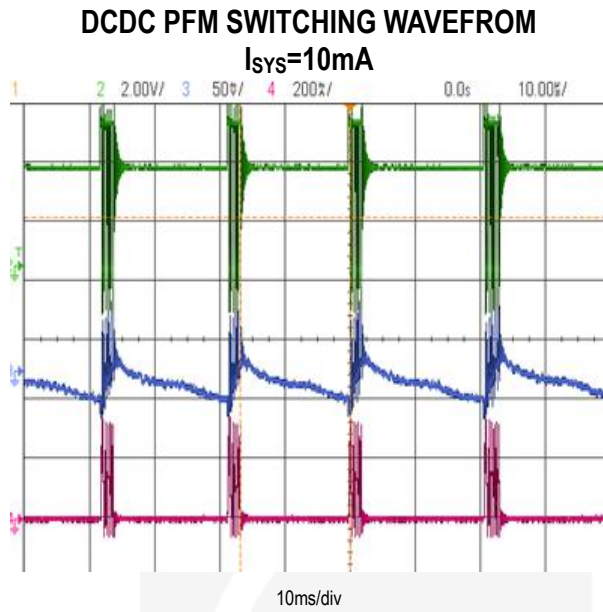

TYPICAL APPLICATION CIRCUIT

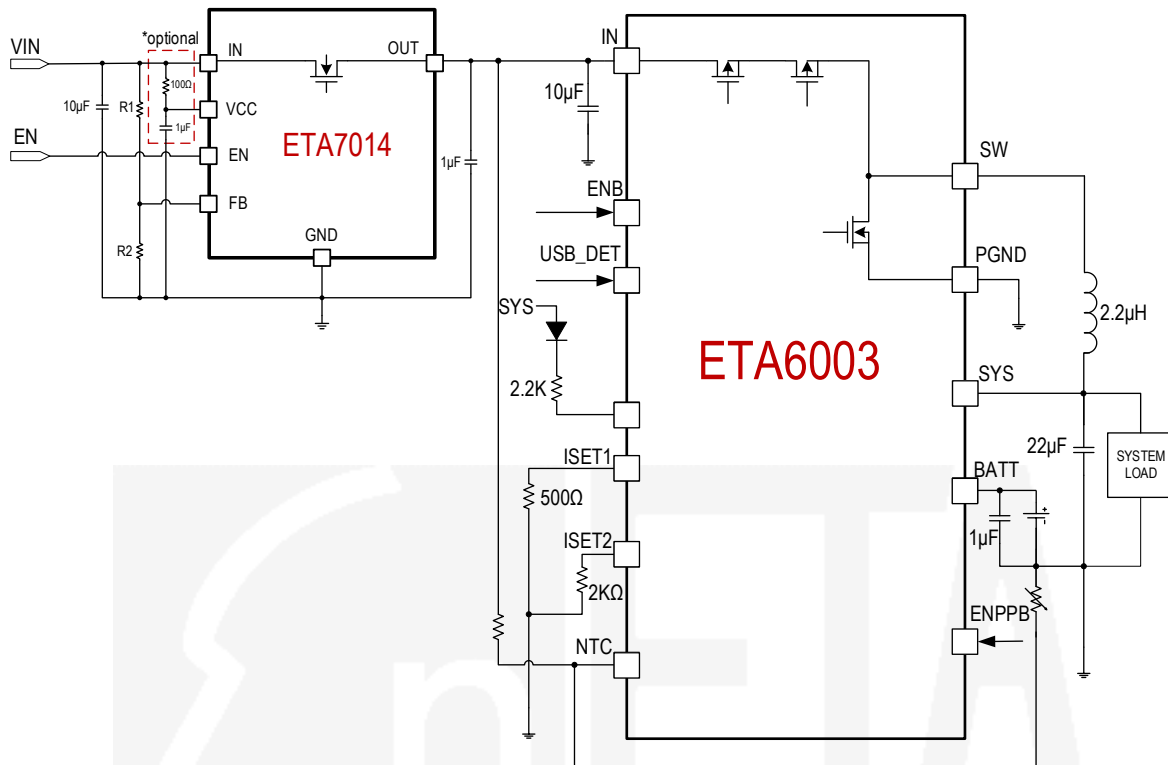

2A Switching Charger with Dynamic Power Path with OVP protection and Charge Enable



## PCB GUIDELINES

PCB layout cautions of ETA6003 is shown below. The input capacitor (Cin) between Vin (Pin2) and PGND (Pin5) is always to be placed closest to the IC. SW wire can be laid through the gap between the 2 Cin terminals. It can go underneath the Cin. For all pins that needs to be shorted to GND, please connect them to GND (Pin10), not to PGND (Pin5). A real PCB layout example is also listed below for reference.

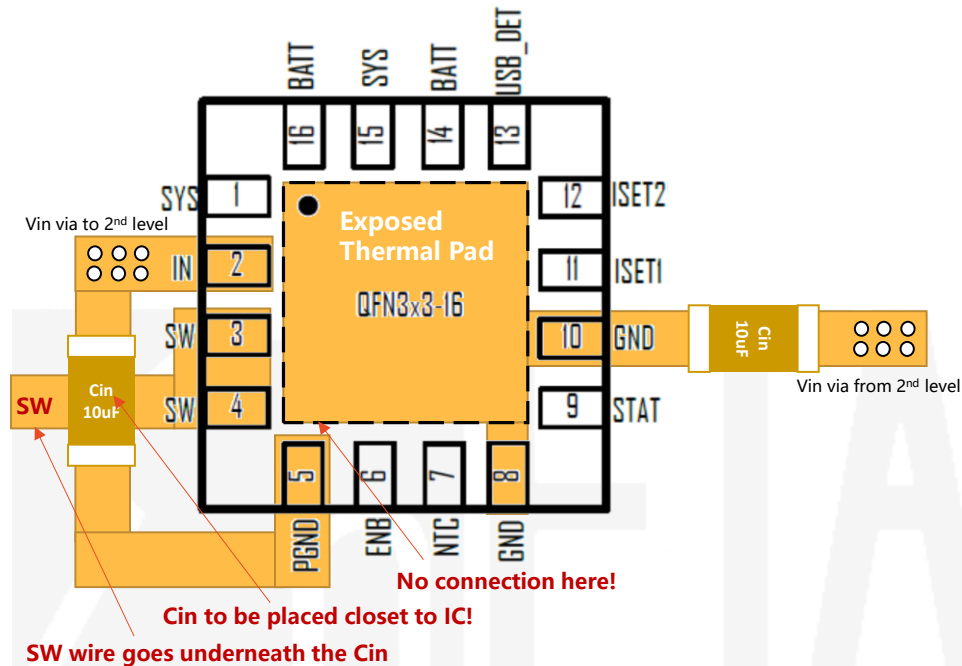

PCB cautions of ETA6003

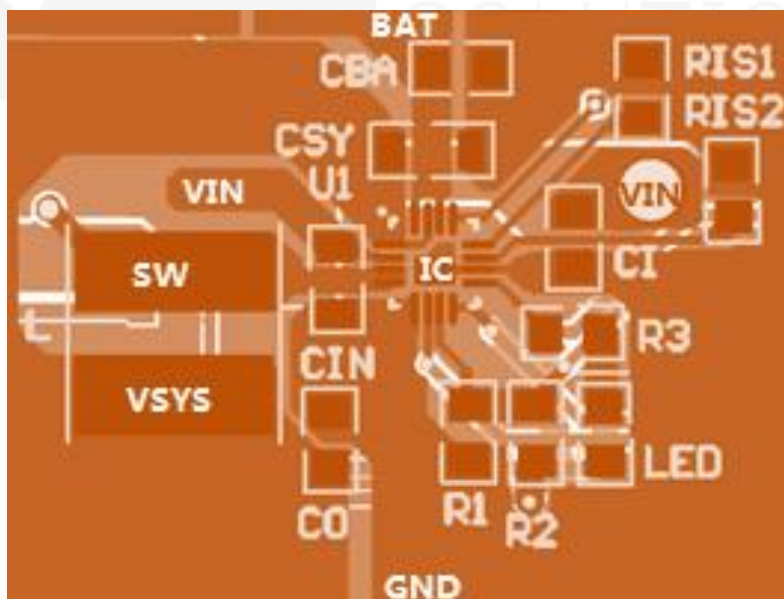

Real DEMO board PCB for reference

PACKAGE OUTLINE

Package: QFN3x3-16

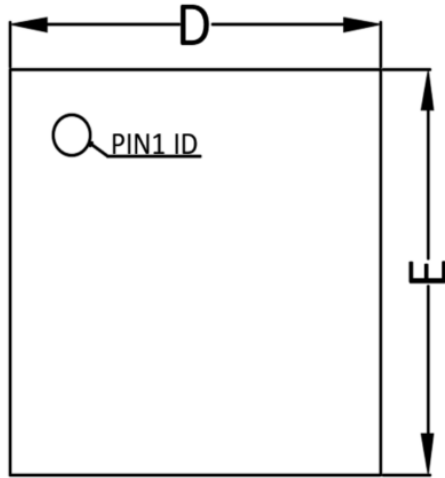

TOP VIEW

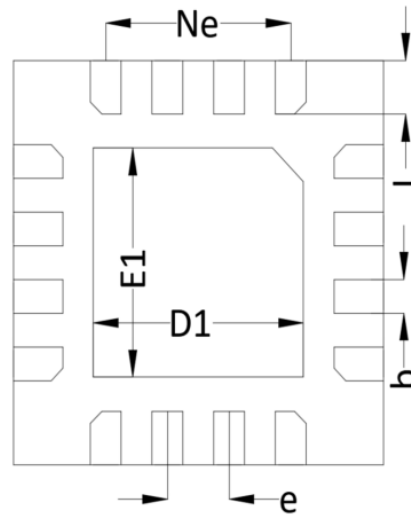

BOTTOM VIEW

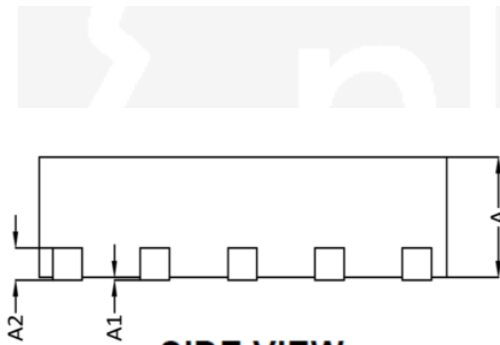

SIDE VIEW

COMMON DIMENSIONS  
(UNITS OF MEASURE=MILLIMETER)

| SYMBOL | MILLIMETER |      |      |
|--------|------------|------|------|
|        | MIN        | NOM  | MAX  |
| A      | 0.70       | 0.75 | 0.80 |
| A1     | 0.00       | 0.02 | 0.05 |
| A2     | 0.203 REF  |      |      |
| D      | 2.90       | 3.00 | 3.10 |
| E      | 2.90       | 3.00 | 3.10 |
| D1     | 1.65       | 1.70 | 1.75 |
| E1     | 1.65       | 1.70 | 1.75 |
| Ne     | 1.50 BSC   |      |      |
| b      | 0.20       | 0.25 | 0.30 |
| L      | 0.35       | 0.40 | 0.45 |
| e      | 0.5 BSC    |      |      |

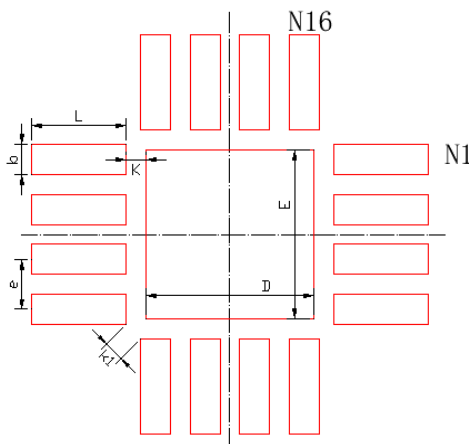

RECOMMENDED LAND PATTERN

| Dimensions | Value | (in mm) |
|------------|-------|---------|
| D          | 1.7   |         |
| E          | 1.7   |         |
| k          | 0.2   |         |
| k 1        | ≥0.2  |         |
| e          | 0.5   |         |
| b          | 0.3   |         |
| L          | 0.95  |         |

TAPE AND REEL INFORMATION

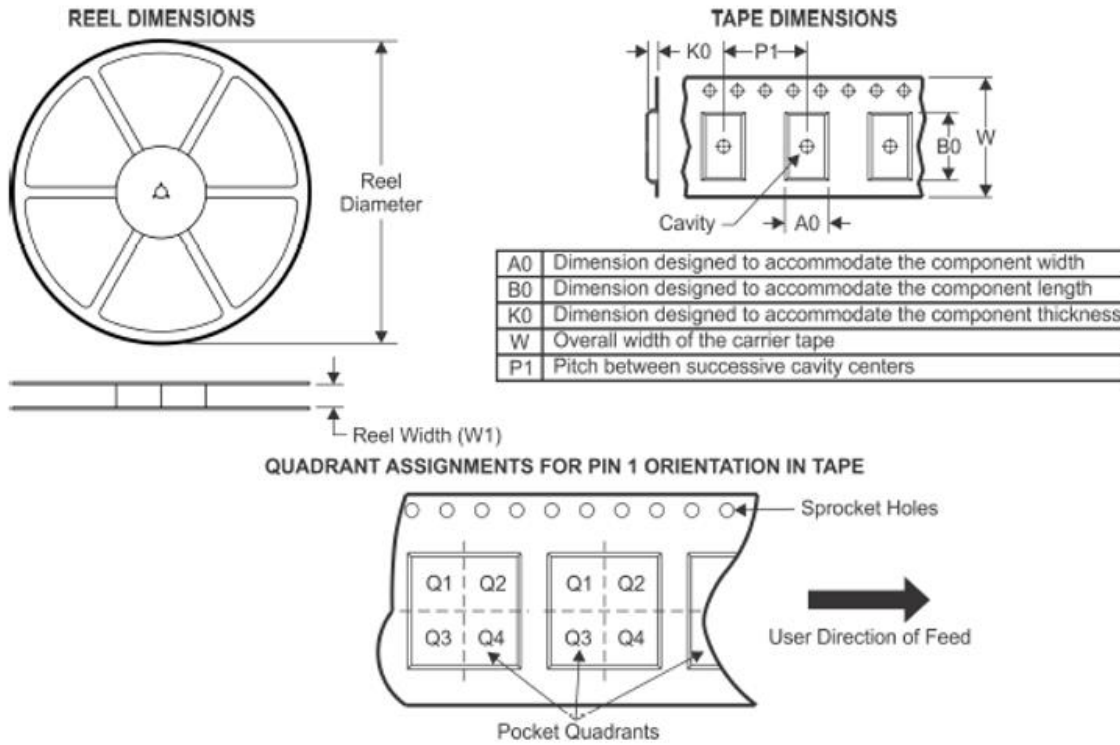

| Device     | Package Type | Pins | SPQ  | Reel Diameter (mm) | Reel Width W1 (mm) | A0 (mm) | B0 (mm) | K0 (mm) | P1 (mm) | W (mm) | Pin1 Quadrant |
|------------|--------------|------|------|--------------------|--------------------|---------|---------|---------|---------|--------|---------------|
| ETA6003Q3Q | QFN3x3-16    | 16   | 5000 | 330                | 12.4               | 3.35    | 3.35    | 1.13    | 8       | 12     | Q1            |