

SMD Power Inductor

201610CDMCD/DS



Description

- Metal compound molding type construction
- Magnetically shielded
- Low audible core noise
- Suitable for large current.
- LxWxH:2.2x1.8x1.0mm Max.
- Product weight: 28mg (Ref.)
- Moisture Sensitivity Level: 1

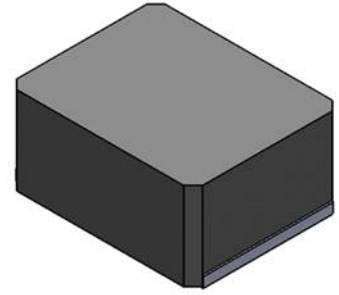

Environmental Data

- Operating temperature range: -55°C~+125°C (including coil's self temperature rise)
- Storage temperature range: -55°C~+125°C

Packaging

- Carrier tape and reel packaging.
- 3000Pcs per reel

Applications

- DC/DC converter for CPU in Notebook PC. Smartphones, LCD displays, HDDs, DVDs, DVCs, DSCs, PDAs ect..
- Thin type on-board power supply module for exchanger VRM for server.
- Low profile, high current power supplies.
- Battery powered devices.

Dimension - [mm]

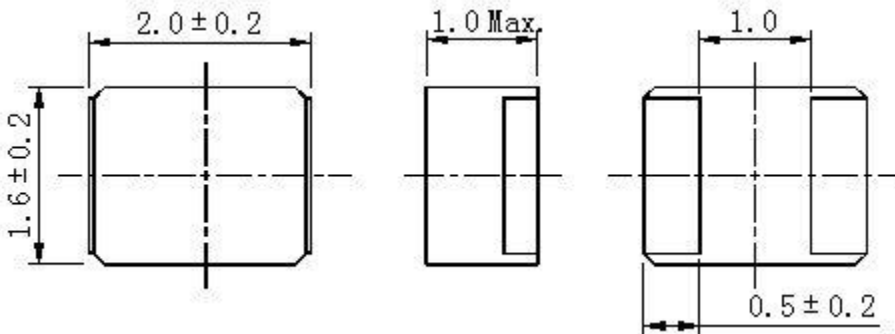

Recommended Land pattern - [mm]

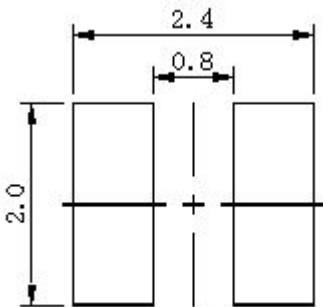

Wire Connection

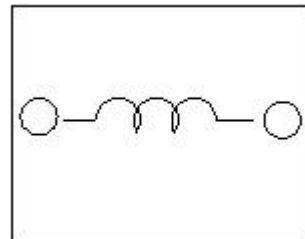

SMD Power Inductor

201610CDMCD/DS



Electrical Characteristics

Part Number	Inductance [Within] (μ H) ※1	D.C.R. at 20°C Max.(Typ.) (m Ω)	Saturation Current (A) Max.(Typ.) ※2	Temperature Rise Current (A) Max.(Typ.) ※3
201610CDMCDDS-R24MC	0.24 \pm 20%	20.00 (16.00)	6.10 (7.20)	(6.30)
201610CDMCDDS-R47MC	0.47 \pm 20%	32.00 (26.00)	4.80 (5.30)	(4.60)
201610CDMCDDS-R68MC	0.68 \pm 20%	43.00 (36.00)	3.60 (4.20)	(4.20)
201610CDMCDDS-1R0MC	1.00 \pm 20%	57.00 (48.00)	3.00 (3.50)	(3.30)

※1 Measuring frequency Inductance at 1MHz,0.1V

※2 Saturation current: This indicates the actual value of D.C. current when the inductance becomes 30% lower than its initial value.

※3 Temperature rise current: The actual value of D.C. current when the temperature of coil becomes $\Delta T=40^{\circ}\text{C}$ ($T_a=25^{\circ}\text{C}$). (Test board condition: FR4, Copper=70 μ m, four-layer PWB t=1.6mm)

Solder Reflow Condition

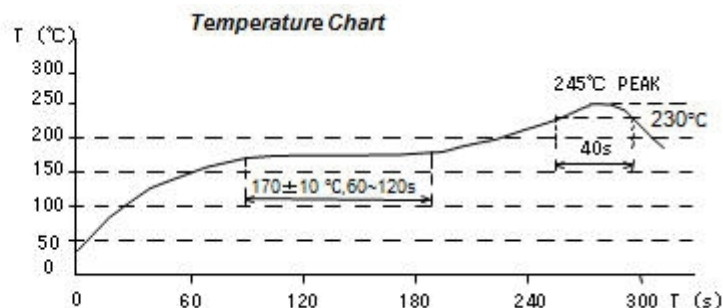
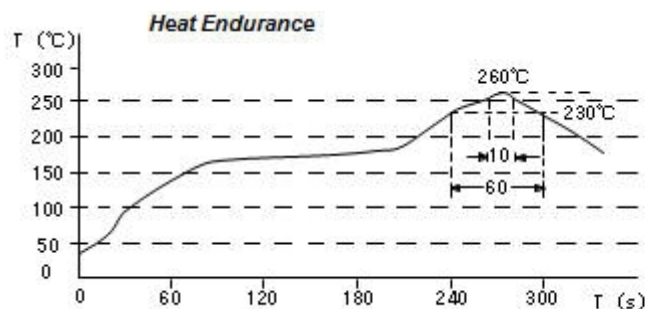

SMD Power Inductor

201610CDMCD/DS



Saturation Current & Temperature Rise Graph

— L (20°C) — ΔT

1. 201610CDMCDDS-R24MC

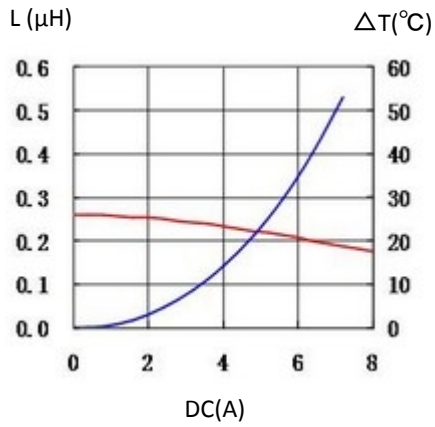

2. 201610CDMCDDS-R47MC

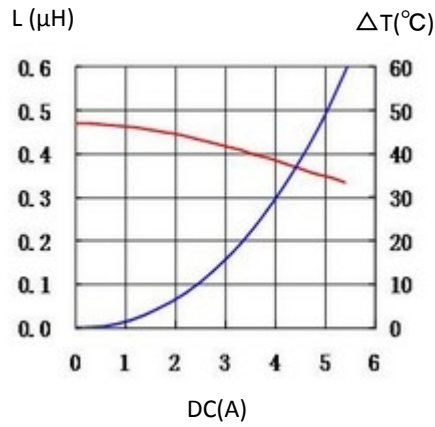

3. 201610CDMCDDS-R68MC

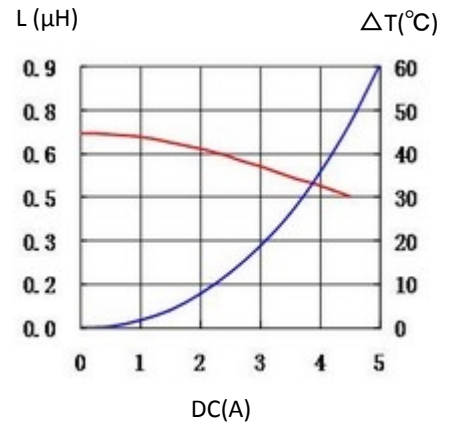

4. 201610CDMCDDS-1R0MC

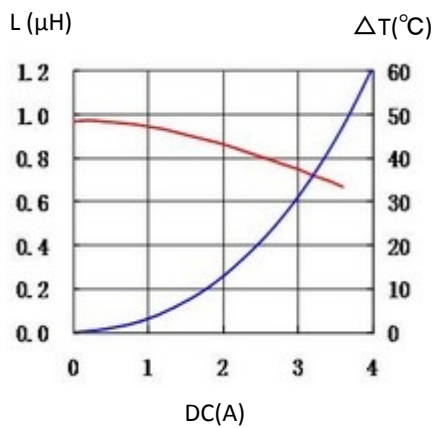

For sales office information, please [click here](#) to visit our website.