

Max.Input 35V Max.Current 1.5A Voltage regulator

LM78XX

General Description

LM78XX is three-terminal positive regulators. One of these regulators can deliver up to 1.5A of output current. The internal limiting and thermal-shutdown features of the regulator make them essentially immune to overload. When used as a replacement for a zener diode-resistor Combination, an effective improvement in output impedance can be obtained, together with lower quiescent current.

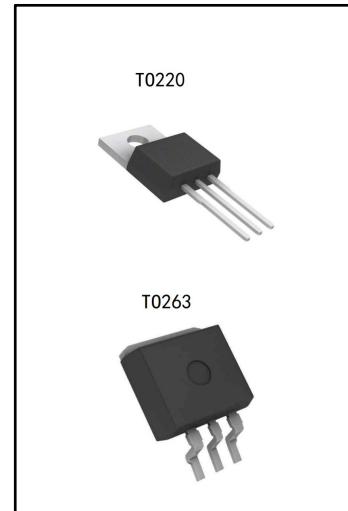

Features

- Maximum Output current of 1.5A
- Maximum input voltage : 35V
- Thermal overload protection
- Short circuit protection
- Built-in limited flow circuit
- Package: TO220 and TO263
- Output voltage accuracy: tolerance $\pm 5\%$

Order specification

Part No	Package	Manner of Packing	Devices per bag/reel
LM78XXCT	TO220	Tube	50PCS/tube
LM78XXCD	TO263	Reel	800PCS/reel

Note: XX indicates output voltage. For example, 05 means product outputs 5.0V.

Selection Table

Part No.	Output Voltage	Package	Marking
LM7805	5.0V	TO220 TO263	7805
LM7806	6.0V		7806
LM7808	8.0V		7808
LM7809	9.0V		7809
LM7812	12V		7812

Block Diagram

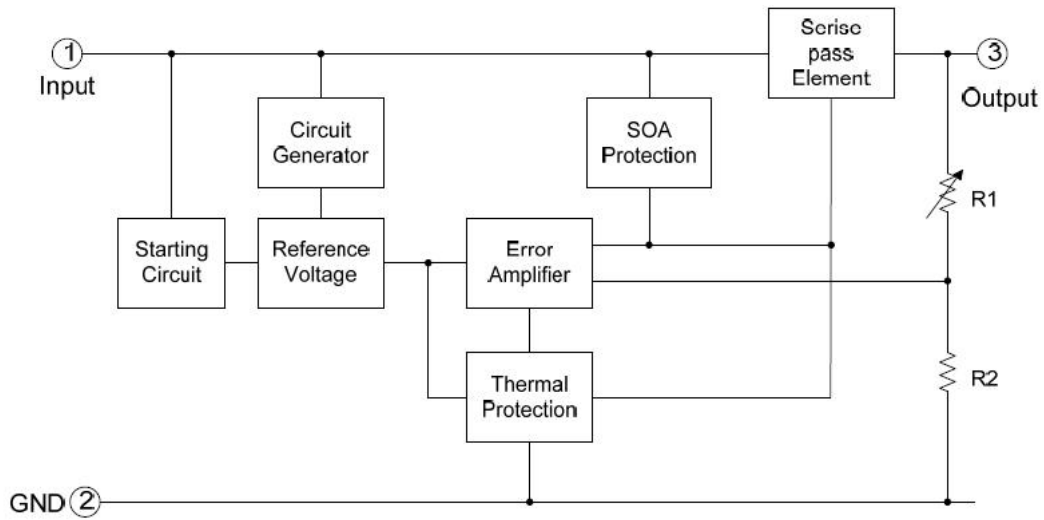

Pin Assignment

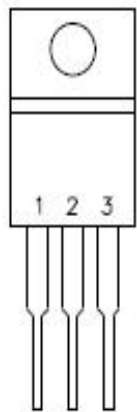

TO-220

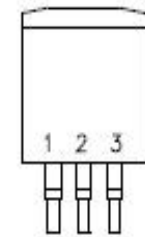

TO-263

PIN NO.	PIN NAME	FUNCTION
1	VIN	Input
2	GND	Ground
3	VOUT	Output

Functional Description

The LM78XX is three-terminal positive regulators. One of these regulators can deliver up to 1.5A of output current.

Absolute Maximum Ratings

Parameter	Symbol	Value	Unit
Input Supply Voltage	V_{IN}	35	V
Max. Output Current	I_{OUT}	1500	mA
Power dissipation	P_D	Internally limited	
Maximum Junction Temperature	T_j	-25~125	°C
Storage Temperature	T_{str}	-65~125	°C
Soldering Temperature and Time	T_{sol}	260(Recommended 10s)	°C

Note: The absolute maximum ratings are rated values exceeding which the product could suffer physical damage. These values must therefore not be exceeded under any conditions.

Electrical Characteristics

1、7805 (refer to the test circuits , $T_J = -55$ to 150 °C , $V_I = 10V$, $I_O = 500mA$, $C_I = 0.33\mu F$, $C_O = 0.1\mu F$, unless otherwise specified.)

Parameter	Symbol	Test Conditions	Min.	Typ.	Max.	Unit	
Output Voltage	V_O	$T_J = +25$ °C	4.8	5	5.2	V	
		$I_O = 5mA$ to $1A$, $P_D \leq 15W$, $V_I = 8V$ to $20V$	4.75	5	5.25	V	
Line Regulation (Note 1)	ΔV_O	$T_J = +25$ °C	$V_I = 7V$ to $25V$	-	-	100	mV
			$V_I = 8V$ to $12V$	-	-	50	mV
Load Regulation (Note 1)	ΔV_O	$T_J = +25$ °C , $I_O = 5mA$ to $1.2A$	-	-	100	mV	
		$T_J = +25$ °C , $I_O = 250mA$ to $750mA$	-	-	50	mV	
Quiescent Current	I_Q	$T_J = +25$ °C	-	2	6	mA	
Quiescent Current Change	ΔI_Q	$I_O = 5mA$ to $1A$	-	-	0.5	mA	
		$V_I = 8V$ to $25V$	-	-	1.5	mA	
Quiescent Current Change	$\Delta V_O / \Delta T$	$I_O = 5mA$	-	0.6	-	mV/ °C	
Short Circuit Current	I_{SC}	$T_J = +25$ °C , $V_I = 35V$	-	0.75	1.5	A	

2、7806 (refer to the test circuits , $T_J = -55$ to 150°C , $V_I = 11\text{V}$, $I_O = 500\text{mA}$, $C_I = 0.33\mu\text{F}$, $C_O = 0.1\mu\text{F}$, unless otherwise specified.)

Parameter	Symbol	Test Conditions	Min.	Typ.	Max.	Unit	
Output Voltage	V_O	$T_J = +25^\circ\text{C}$	5.75	6	6.25	V	
		$I_O = 5\text{mA}$ to 1A , $P_D \leq 15\text{W}$, $V_I = 9\text{V}$ to 21V	5.65	6	6.35	V	
Line Regulation (Note 1)	ΔV_O	$T_J = +25^\circ\text{C}$	$V_I = 8\text{V}$ to 25V	-	-	100	mV
			$V_I = 9\text{V}$ to 13V	-	-	50	mV
Load Regulation (Note 1)	ΔV_O	$T_J = +25^\circ\text{C}$, $I_O = 5\text{mA}$ to 1.2A	-	-	100	mV	
		$T_J = +25^\circ\text{C}$, $I_O = 250\text{mA}$ to 750mA	-	-	50	mV	
Quiescent Current	I_Q	$T_J = +25^\circ\text{C}$	-	2	6	mA	
Quiescent Current Change	ΔI_Q	$I_O = 5\text{mA}$ to 1A	-	-	0.5	mA	
		$V_I = 9\text{V}$ to 25V	-	-	0.8	mA	
Quiescent Current Change	$\Delta V_O / \Delta T$	$I_O = 5\text{mA}$	-	0.7	-	mV/ $^\circ\text{C}$	
Short Circuit Current	I_{SC}	$T_J = +25^\circ\text{C}$, $V_I = 35\text{V}$	-	0.75	1.5	A	

3、7808 (refer to the test circuits , $T_J = -55$ to 150°C , $V_I = 14\text{V}$, $I_O = 500\text{mA}$, $C_I = 0.33\mu\text{F}$, $C_O = 0.1\mu\text{F}$, unless otherwise specified.)

Parameter	Symbol	Test Conditions	Min.	Typ.	Max.	Unit	
Output Voltage	V_O	$T_J = +25^\circ\text{C}$	7.7	8	8.3	V	
		$I_O = 5\text{mA}$ to 1A , $P_D \leq 15\text{W}$, $V_I = 11.5\text{V}$ to 23V	7.6	8	8.4	V	
Line Regulation (Note 1)	ΔV_O	$T_J = +25^\circ\text{C}$	$V_I = 10.5\text{V}$ to 25V	-	-	100	mV
			$V_I = 11\text{V}$ to 17V	-	-	50	mV
Load Regulation (Note 1)	ΔV_O	$T_J = +25^\circ\text{C}$, $I_O = 5\text{mA}$ to 1.2A	-	-	100	mV	
		$T_J = +25^\circ\text{C}$, $I_O = 250\text{mA}$ to 750mA	-	-	50	mV	
Quiescent Current	I_Q	$T_J = +25^\circ\text{C}$	-	2	6	mA	
Quiescent Current Change	ΔI_Q	$I_O = 5\text{mA}$ to 1A	-	-	0.5	mA	
		$V_I = 11.5\text{V}$ to 25V	-	-	1	mA	
Quiescent Current Change	$\Delta V_O / \Delta T$	$I_O = 5\text{mA}$	-	1	-	mV/ $^\circ\text{C}$	
Short Circuit Current	I_{SC}	$T_J = +25^\circ\text{C}$, $V_I = 35\text{V}$	-	0.75	1.5	A	

4、7809 (refer to the test circuits , $T_J = -55$ to 150°C , $V_I = 15\text{V}$, $I_O = 500\text{mA}$, $C_I = 0.33\mu\text{F}$, $C_O = 0.1\mu\text{F}$, unless otherwise specified.)

Parameter	Symbol	Test Conditions	Min.	Typ.	Max.	Unit	
Output Voltage	V_O	$T_J = +25^\circ\text{C}$	8.64	9	9.36	V	
		$I_O = 5\text{mA}$ to 1A , $P_D \leq 15\text{W}$, $V_I = 11.5\text{V}$ to 26V	8.55	9	9.45	V	
Line Regulation (Note 1)	ΔV_O	$T_J = +25^\circ\text{C}$	$V_I = 11.5\text{V}$ to 26V	-	-	100	mV
			$V_I = 12\text{V}$ to 18V	-	-	50	mV
Load Regulation (Note 1)	ΔV_O	$T_J = +25^\circ\text{C}$, $I_O = 5\text{mA}$ to 1.2A	-	-	100	mV	
		$T_J = +25^\circ\text{C}$, $I_O = 250\text{mA}$ to 750mA	-	-	50	mV	
Quiescent Current	I_Q	$T_J = +25^\circ\text{C}$	-	2	6	mA	
Quiescent Current Change	ΔI_Q	$I_O = 5\text{mA}$ to 1A	-	-	0.5	mA	
		$V_I = 11.5\text{V}$ to 26V	-	-	1	mA	
Quiescent Current Change	$\Delta V_O / \Delta T$	$I_O = 5\text{mA}$	-	1	-	mV/ $^\circ\text{C}$	
Short Circuit Current	I_{SC}	$T_J = +25^\circ\text{C}$, $V_I = 35\text{V}$	-	0.75	1.5	A	

5、7812 (refer to the test circuits , $T_J = -55$ to 150°C , $V_I = 19\text{V}$, $I_O = 500\text{mA}$, $C_I = 0.33\mu\text{F}$, $C_O = 0.1\mu\text{F}$, unless otherwise specified.)

Parameter	Symbol	Test Conditions	Min.	Typ.	Max.	Unit	
Output Voltage	V_O	$T_J = +25^\circ\text{C}$	11.5	12	12.5	V	
		$I_O = 5\text{mA}$ to 1A , $P_D \leq 15\text{W}$, $V_I = 15.5\text{V}$ to 27V	11.4	12	12.6	V	
Line Regulation (Note 1)	ΔV_O	$T_J = +25^\circ\text{C}$	$V_I = 14.5\text{V}$ to 30V	-	-	100	mV
			$V_I = 16\text{V}$ to 22V	-	-	50	mV
Load Regulation (Note 1)	ΔV_O	$T_J = +25^\circ\text{C}$, $I_O = 5\text{mA}$ to 1.2A	-	-	100	mV	
		$T_J = +25^\circ\text{C}$, $I_O = 250\text{mA}$ to 750mA	-	-	50	mV	
Quiescent Current	I_Q	$T_J = +25^\circ\text{C}$	-	2	6	mA	
Quiescent Current Change	ΔI_Q	$I_O = 5\text{mA}$ to 1A	-	-	0.5	mA	
		$V_I = 15\text{V}$ to 30V	-	-	1	mA	
Quiescent Current Change	$\Delta V_O / \Delta T$	$I_O = 5\text{mA}$	-	1.5	-	mV/ $^\circ\text{C}$	
Short Circuit Current	I_{SC}	$T_J = +25^\circ\text{C}$, $V_I = 35\text{V}$	-	0.75	1.5	A	

LNR: Line Regulation. The change in output voltage for a change in the input voltage. The measurement is made under conditions of low dissipation or by using pulse techniques such that the average chip temperature is not significantly affected.

LDR: Load Regulation. The change in output voltage for a change in load current at constant chip temperature.

Application Circuits

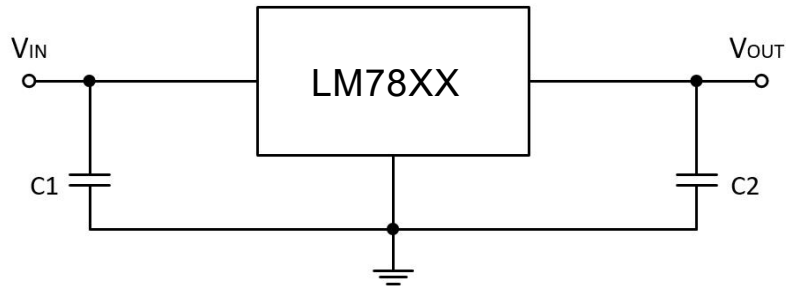

$$C1=C2=1\mu\text{F}$$

Typical Performance Characteristics

Figure 1: Dropout voltage vs Junction temperature

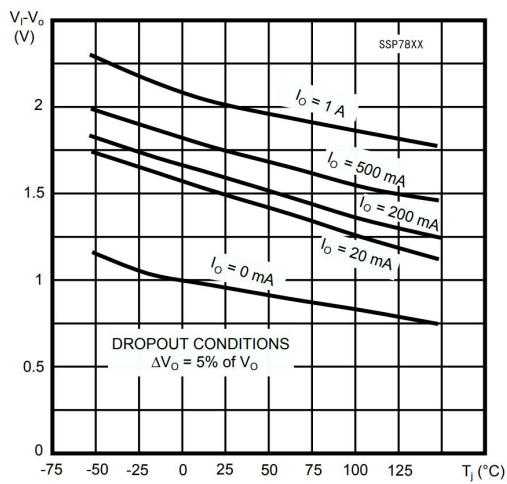

Figure 2: Peak output current vs Input/output differential voltage

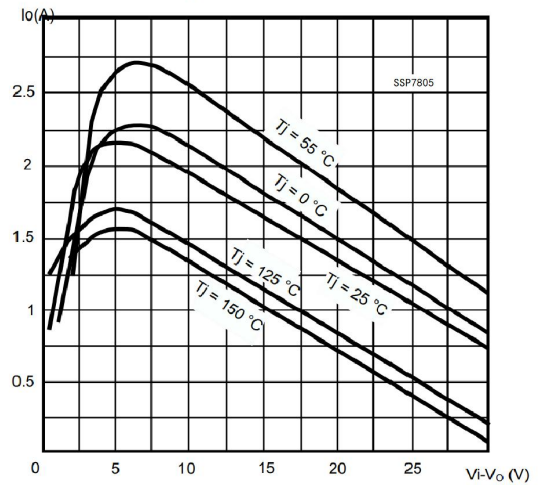

Figure 3: Supply voltage rejection vs Frequency temperature

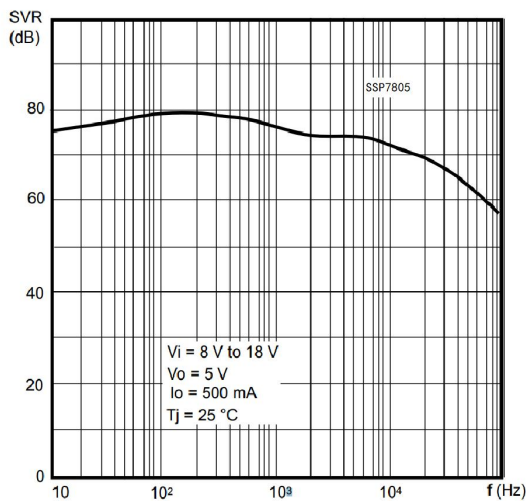

Figure 4: Quiescent current vs Junction

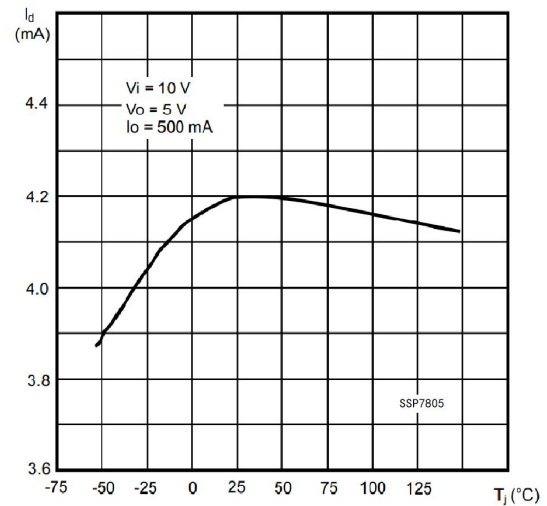

Figure 5: Output voltage vs Junction temperature

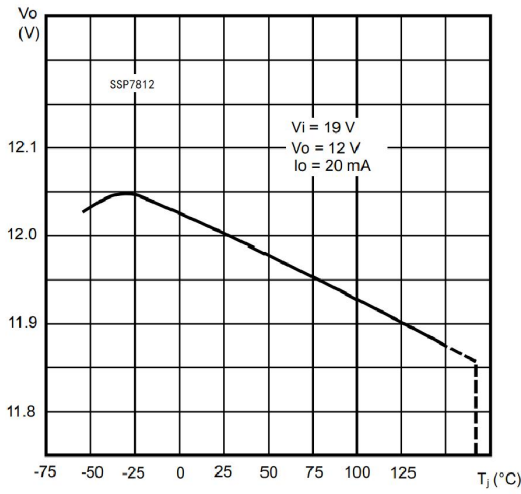

Figure 6: Load transient response

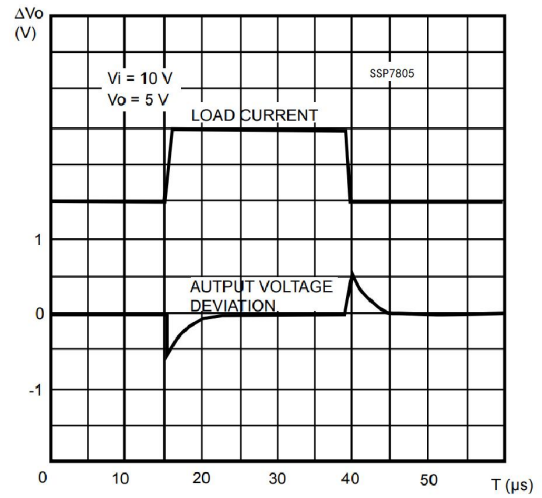

Figure 7: Output impedance vs Frequency

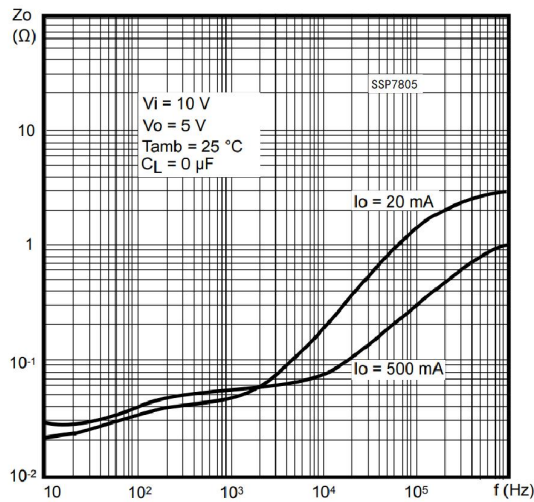

Figure 8: Line transient response

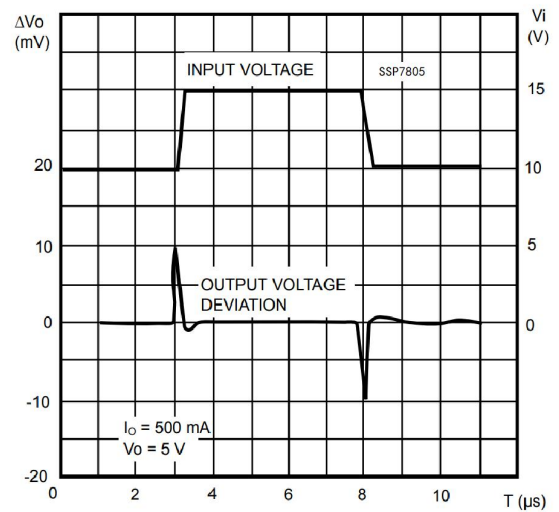
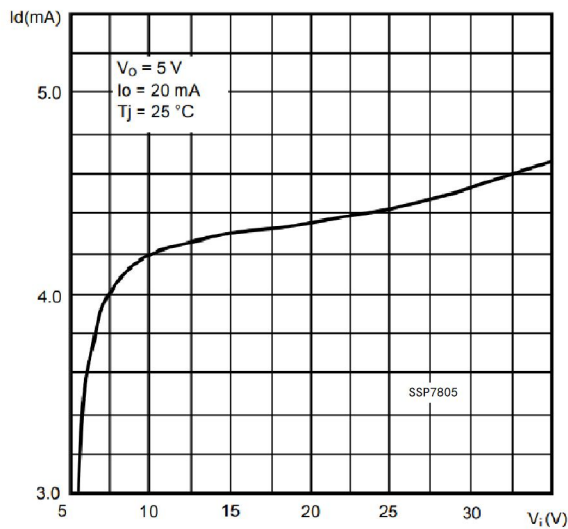
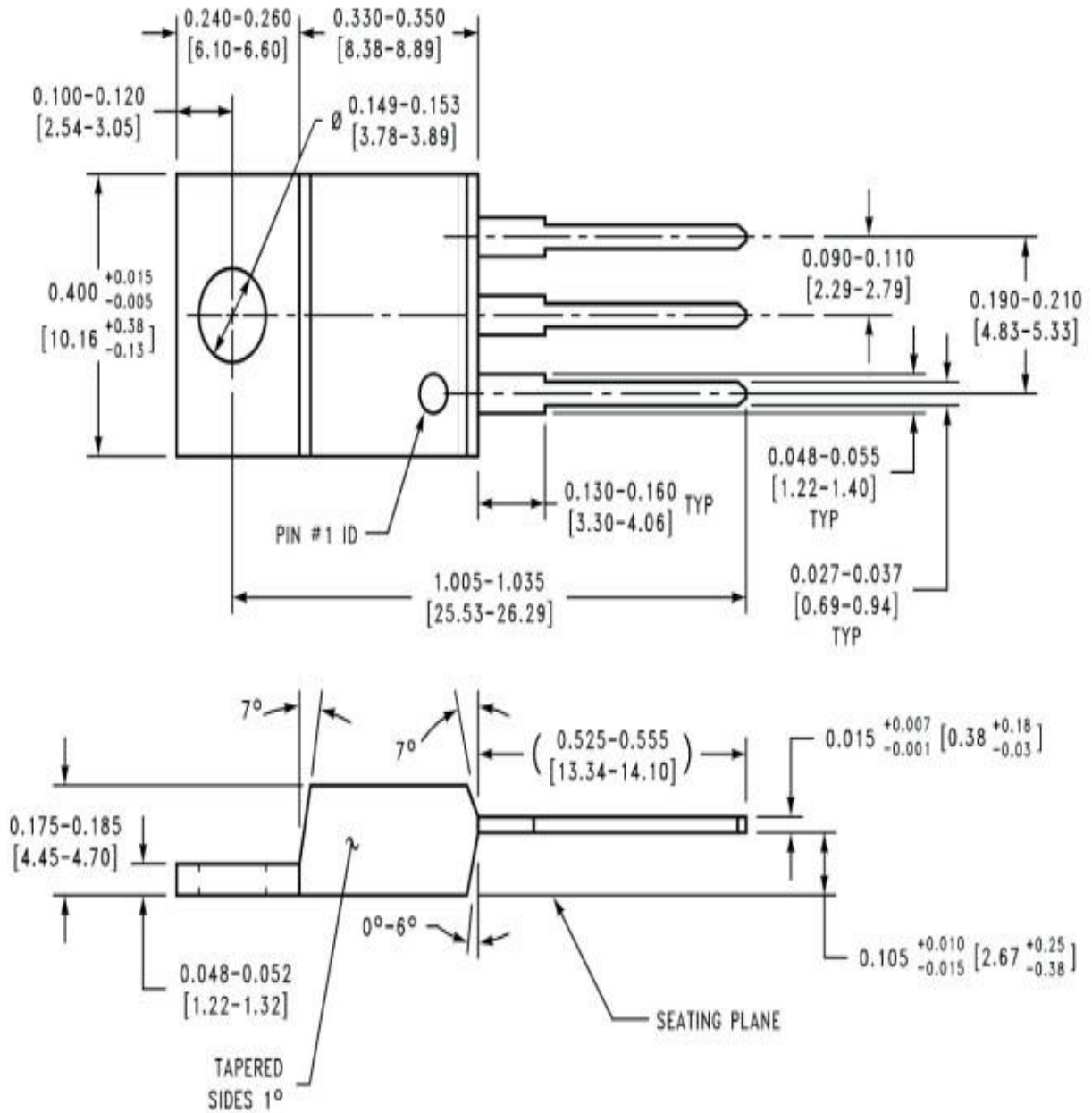

Figure9: Quiescent current vs Input voltage



Package Information (TO220)



Package Information (TO263)

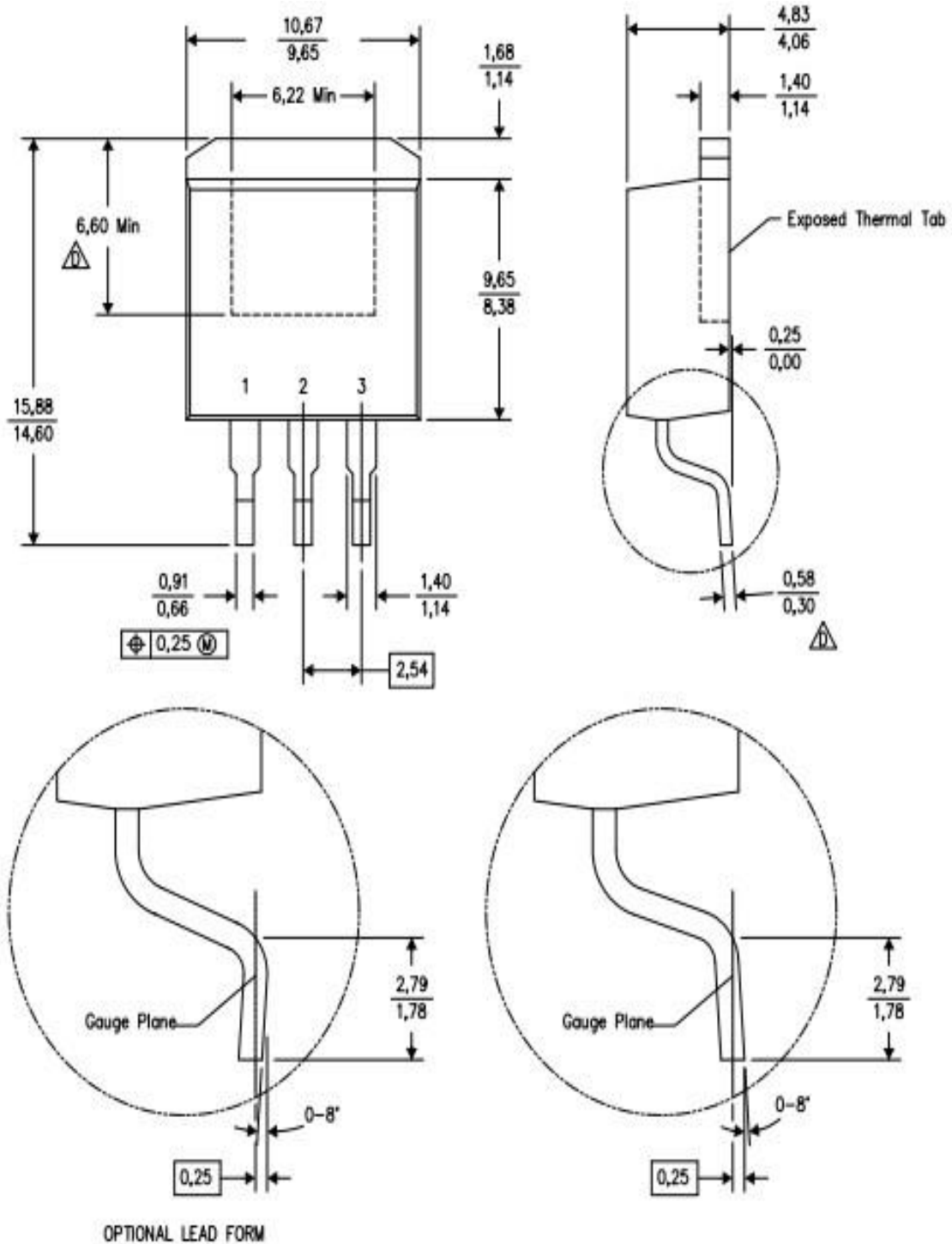

Special Instructions

The company reserves the right of final interpretation of this specification.

Version Change Description

Version: V1.2

Author: Yangyang

Time: 2021.3.10

Modify the record:

1. Re-typesetting the manual and checking some data
-

Statement

The information in the usage specification is correct at the time of publication, Shanghai Siproin Microelectronics Co. has the right to change and interpret the specification, and reserves the right to modify the product without prior notice. Users can obtain the latest version information from our official website or other effective channels before confirmation, and verify whether the relevant information is complete and up to date.

With any semiconductor product, there is a certain possibility of failure or failure under certain conditions. The buyer is responsible for complying with safety standards and taking safety measures when using the product for system design and complete machine manufacturing. The product is not authorized to be used as a critical component in life-saving or life-sustaining products or systems, in order to avoid potential failure risks that may cause personal injury or property loss.