

1.2-Watts Mono Filter-free Audio Power Amplifier

Features

- 2.5-5.5V Operation Voltage
- 63dB PSRR at 217Hz, VDD=5V
- 0.1 μ A ultra low current shutdown mode
- Improved pop & click circuitry
- Unique Modulation Scheme Reduces EMI Emissions
- 0.1- μ A Shutdown Current
- No output coupling capacitors, snubber networks or bootstrap capacitors required
- External gain configuration capability
- Shutdown Pin has 0.4V Compatible Thresholds
- BTL output can drive capacitive loads
- RoHS compliant and 100% lead(Pb)-free

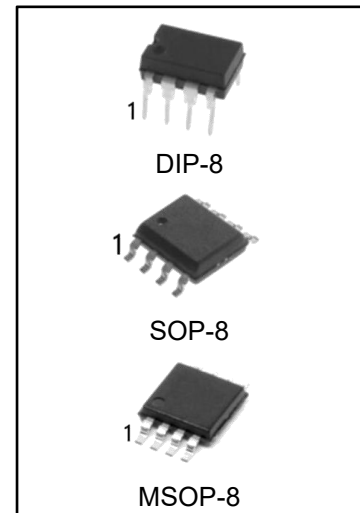

Applications

- PMP,PSP, Game, Data-Bank
- Cellular and Smart mobile phone

Ordering Information

DEVICE	Package Type	MARKING	Packing	Packing Qty
LM4890N	DIP-8	LM4890	TUBE	2000/box
LM4890M/TR	SOP-8	LM4890	REEL	2500/reel
LM4890MM/TR	MSOP-8	4890	REEL	3000/reel

General Description

The LM4890 is an audio power amplifier designed for portable communication device applications such as mobile phone applications. The LM4890 is capable of delivering 1.2W of continuous average power to an 8 Ω load and with less than 1% distortion (THD+N) from a 5.2V power supply, and 350mW to a 8 Ω load from a 3V power supply.

The LM4890 provides high quality audio while requiring few external components and minimal power consumption. It features a low-power shutdown mode, which is achieved by driving the SHUTDOWN pin with logic low.

The LM4890 contains circuitry to prevent from “pop and click” noise that would otherwise occur during turn-on and turn-off transitions. For maximum flexibility, the LM4890 provides an externally controlled gain (with resistors), as well as an externally controlled turn-on and turn-off times (with the bypass capacitor).

Typical Application Circuit

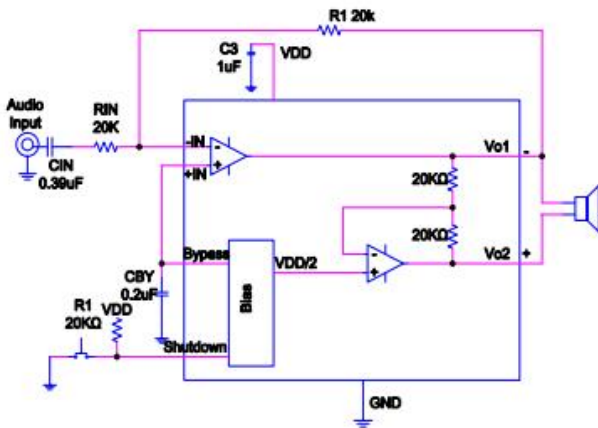

Figure 1.Single Input

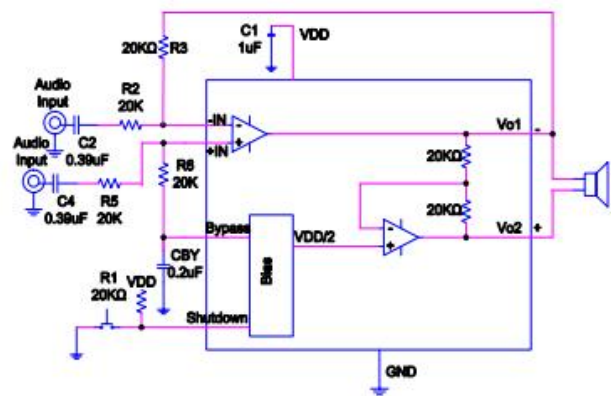
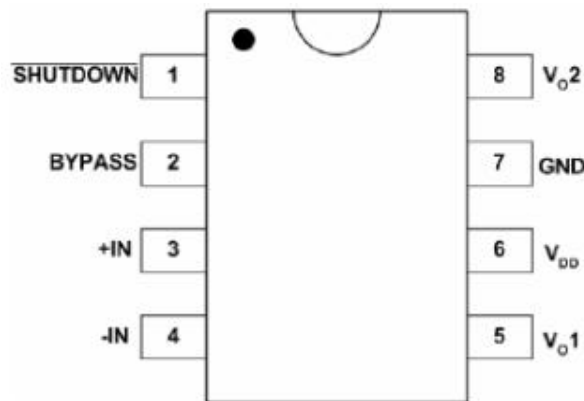

Figure 2.Differential Input

Functional Pin Description

Pin Configurations



DIP-8/SOP-8/MSOP-8

Pin Description

Pin	Name	Description
1	SHDN	The device enters in shutdown mode when a low level is applied on this pin.
2	BYPASS	Bypass capacitor pin which provides the common mode voltage.
3	+IN	Positive input of the first amplifier, receives the common mode voltage.
4	-IN	Negative input of the first amplifier, receives the audio input signal. Connected to the feedback resistor R_f and to the input resistor R_{in} .
5	VO1	Negative output of the LM4890. Connected to the load and to the feedback resistor R_f .
6	VDD	Analog VDD input supply.
7	GND	Ground connection for circuitry.
8	VO2	Positive output of the LM4890.

Absolute Maximum Ratings

Condition	Min	Max
Input Voltage to GND	-0.3V	6V
Other pin Voltage to GND	-0.3V	6V
Junction Temperature, T_{JMAX}	-	150°C
Storage Temperature Rang, T_{stg}	-65°C	150°C
ESD Susceptibility	-	2kV
Maximum Soldering Temperature (at leads, 10 sec)	-	260°C
Thermal Resistance θ_{JA}	-	165°C/W
Package Dissipation P_D	-	0.9W

Electrical Characteristics

Symbol	Parameter	Conditions	Min.	Typ.	Max.	Unit	
VOS	Output offset voltage (measured differentially)	$V_i=0V, A_v=2V/V, V_{DD}=2.5V$ to 5.5V		5	25	mV	
IQ	Quiescent current	VDD=5.5V, no load		2.5		mA	
		VDD=3.6V, no load		1.40			
		VDD=2.5V, no load		1.06			
ISHDN	Shutdown Current	VSHDN=0.35V, VDD=2.5V to 5.5V	0.1	2.0		μA	
RDS(ON)	Static drain-source on-state resistance	VDD=5.5V, no load		400		mΩ	
		VDD=3.6V, no load		500			
		VDD=2.5V, no load		700			
Po	Output power	VDD=5.2V, $R_L=8\Omega$, THD=1%, f=1KHz		1.2		W	
VSHDN	Start up voltage threshold		1.4			V	
	Shutdown voltage threshold				0.4		
THD+N	Total harmonic distortion plus noise	VDD=5V, $P_o=1W, R_L=8\Omega, f=1KHz$		0.123		%	
		VDD=3.6V, $P_o=0.5W, R_L=8\Omega, f=1KHz$		0.130			
		VDD=2.5V, $P_o=0.2W, R_L=8\Omega, f=1KHz$		0.163			
PSRR	Supply ripple rejection ratio	VDD=3.6V, Inputs ac-grounded with $C_i=2\mu F$	F=217Hz, V(ripple)=200mV		-63		dB
CMRR	Common mode rejection ratio	VDD=3.6V, $V_{ic}=1V_{pp}$	F=217Hz		-62		dB
Zt	Start-up time from shutdown	VDD=3.6V		45			mS

Typical Operating Characteristics

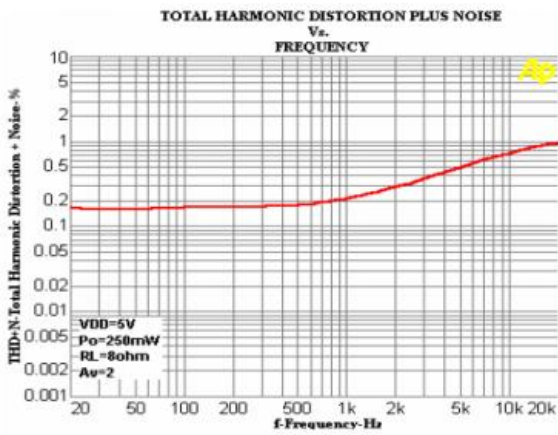

Figure 3.

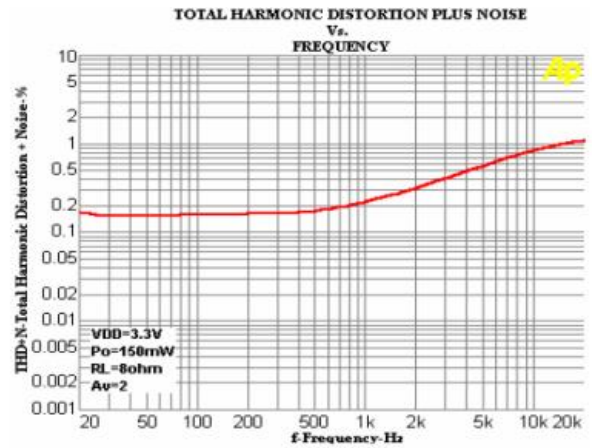

Figure 4.

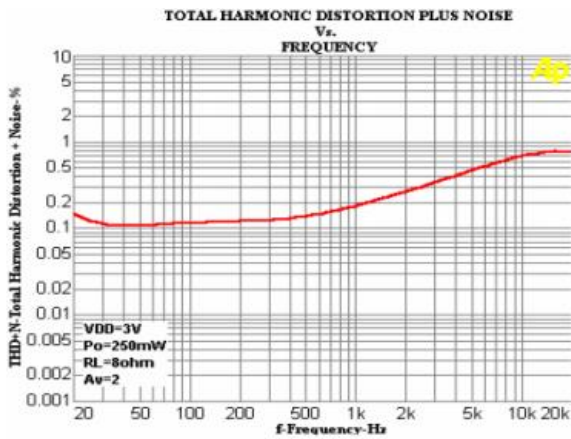

Figure 5.

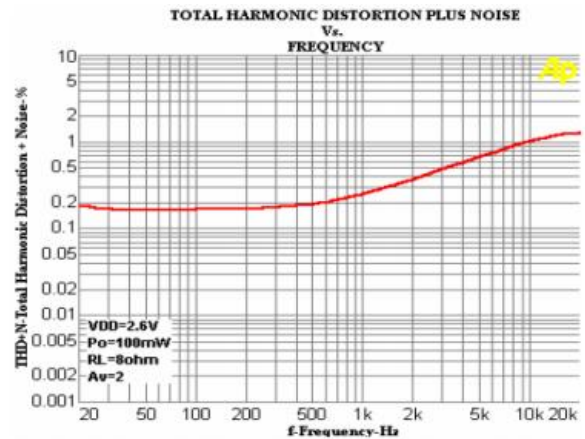

Figure 6.

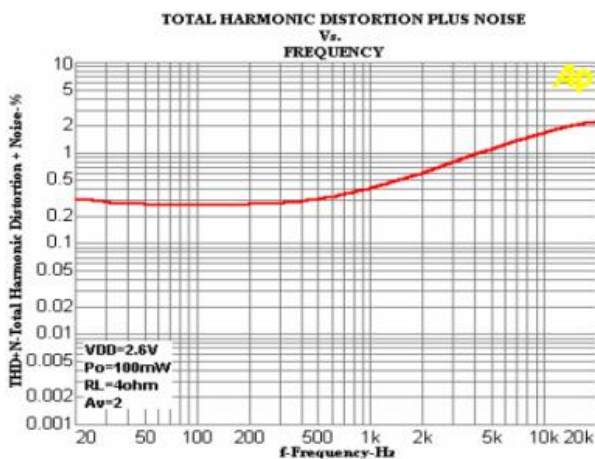

Figure 7.

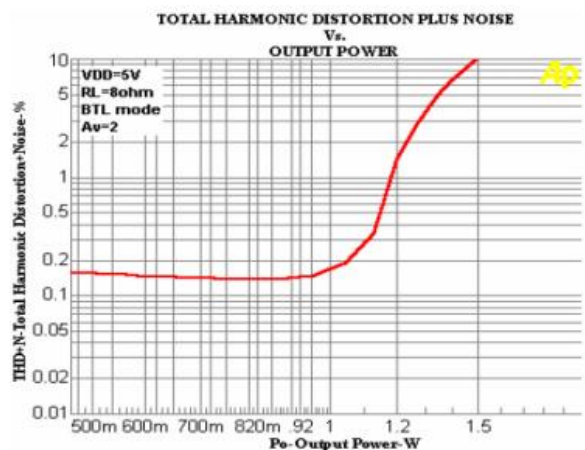

Figure 8.

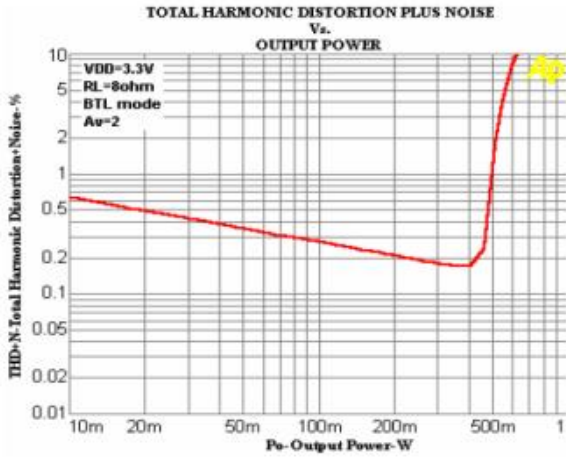

Figure 9.

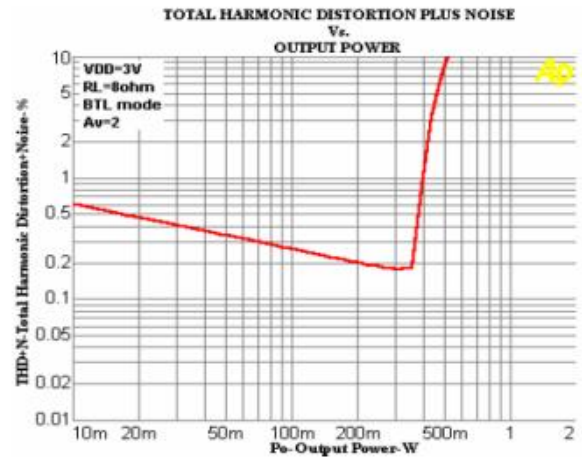

Figure 10.

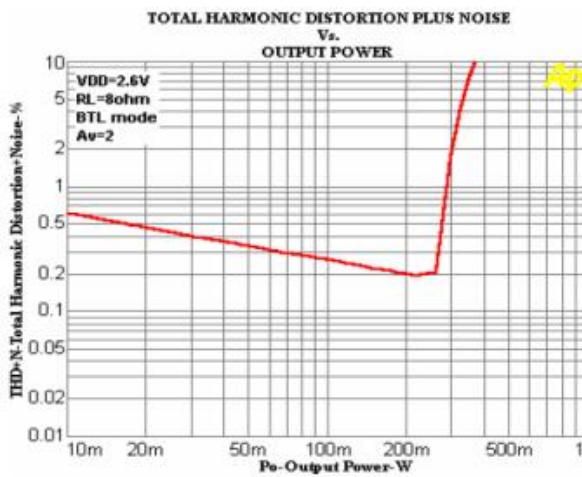

Figure 11.

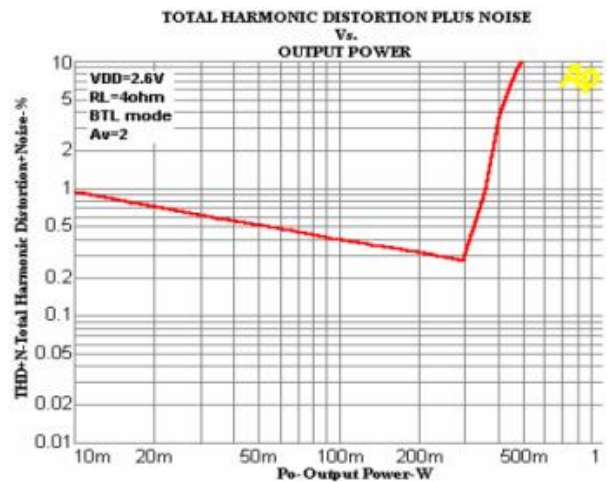

Figure 12.

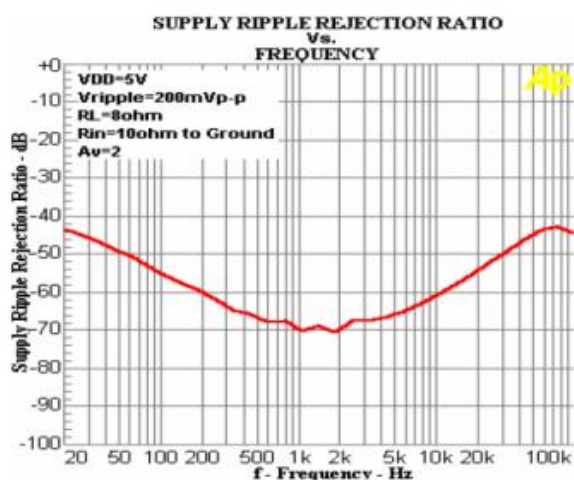

Figure 13.

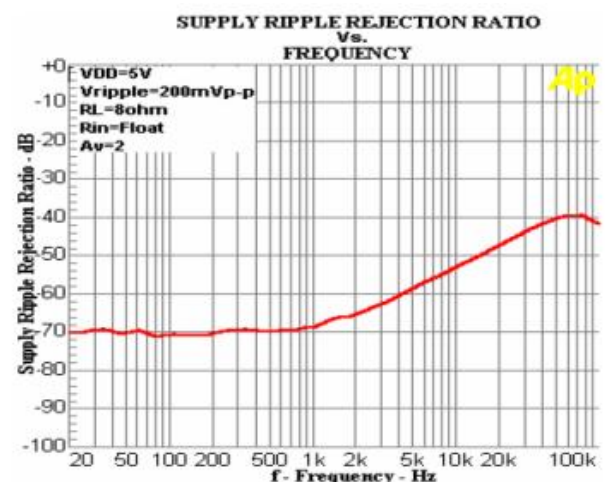

Figure 14.

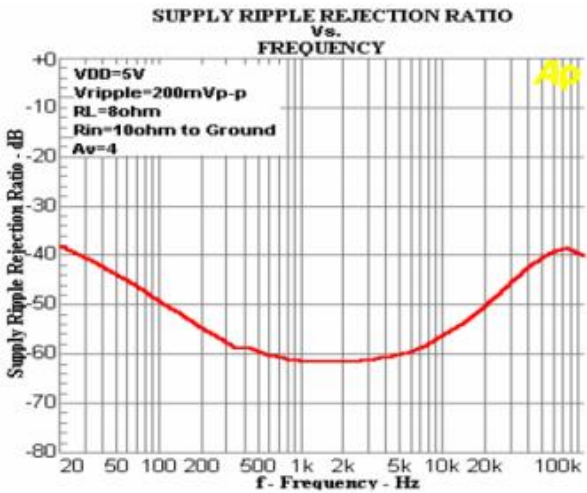

Figure 15.

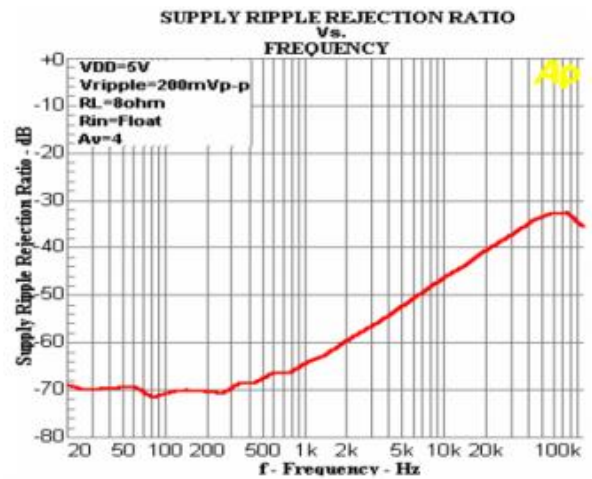

Figure 16.

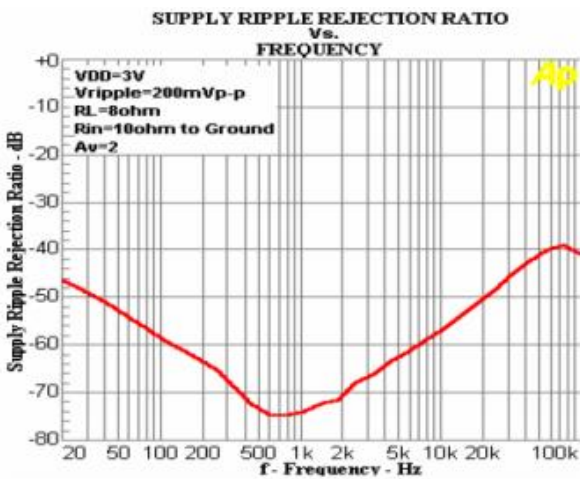

Figure 17.

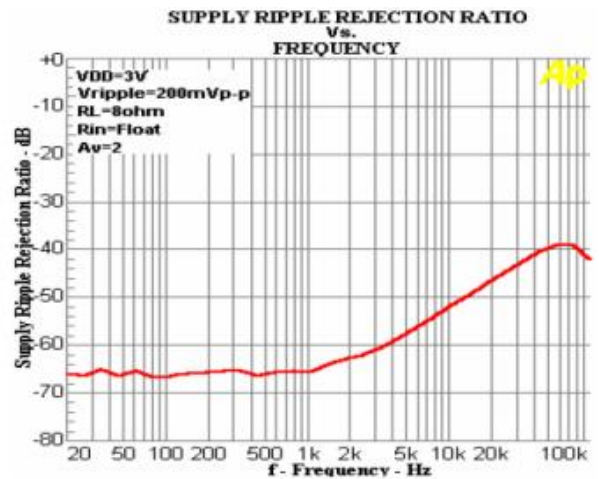

Figure 18.

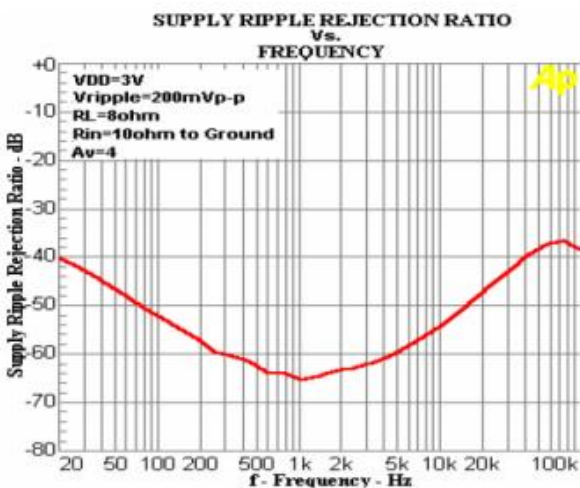

Figure 19.

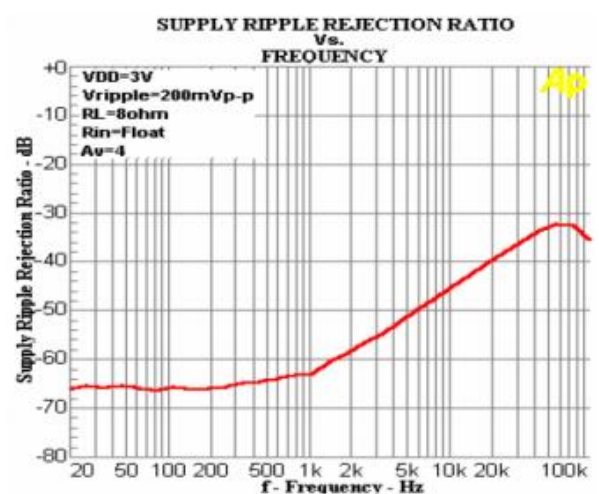

Figure 20.

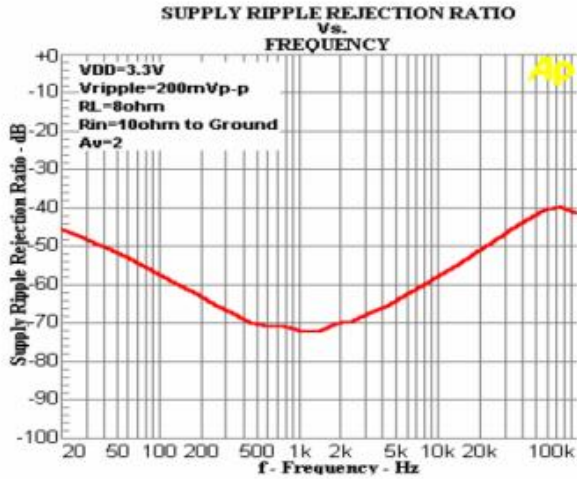

Figure 21.

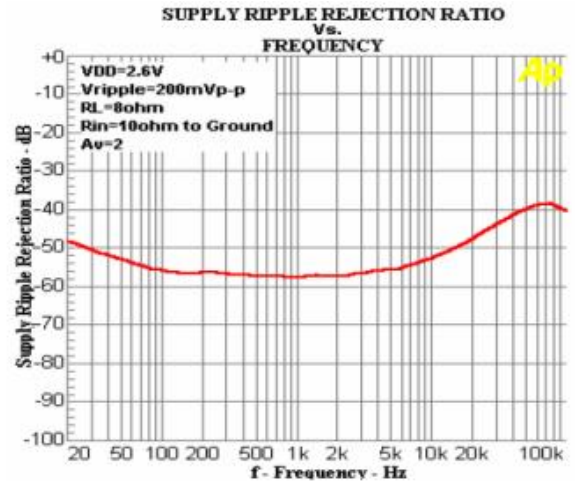

Figure 22.

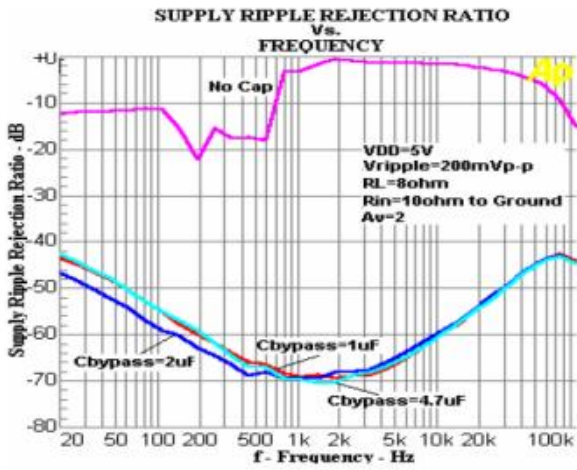

Figure 23.

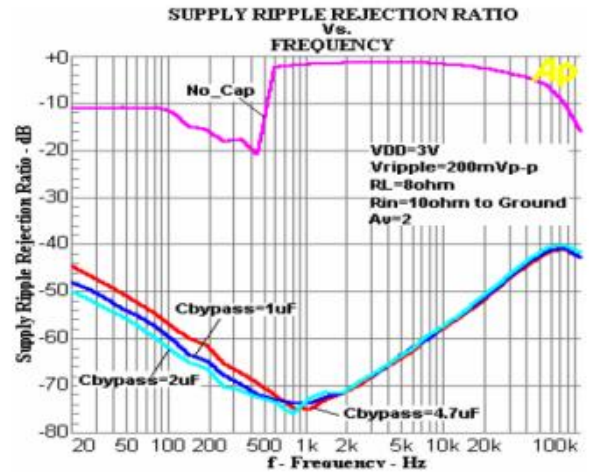

Figure 24.

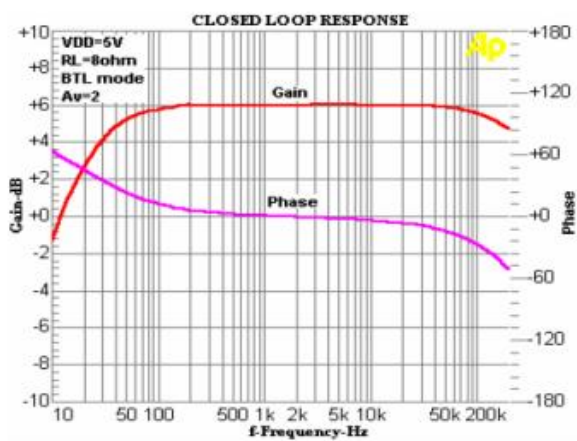

Figure 25.

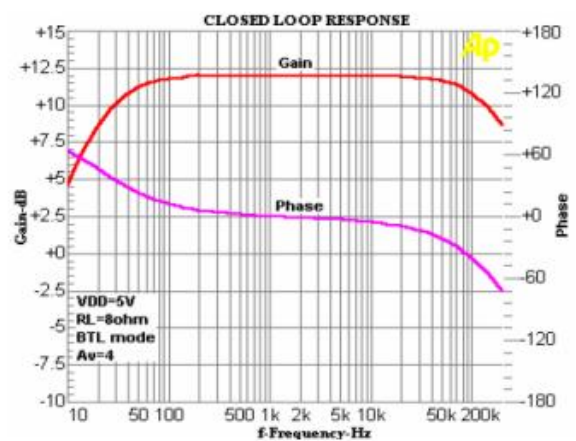

Figure 26.

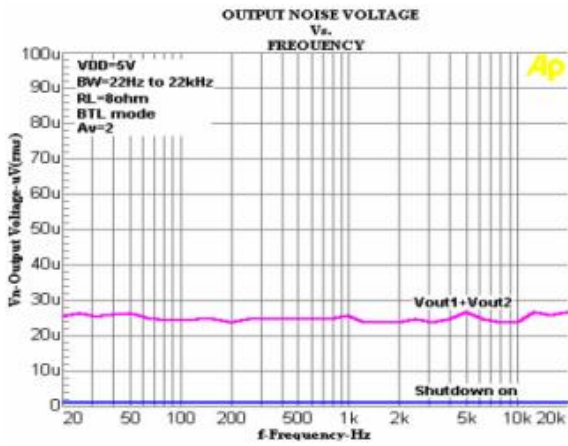

Figure 27.

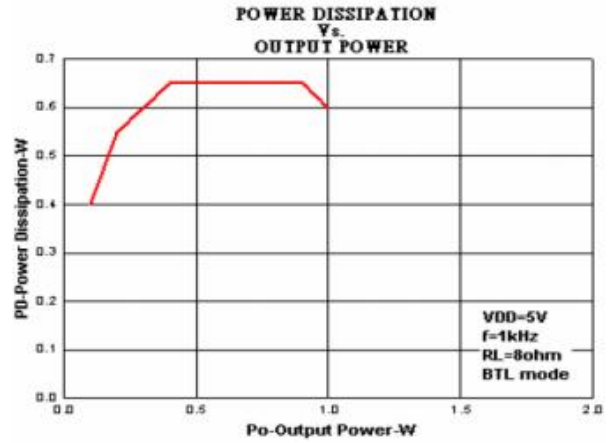

Figure 28.

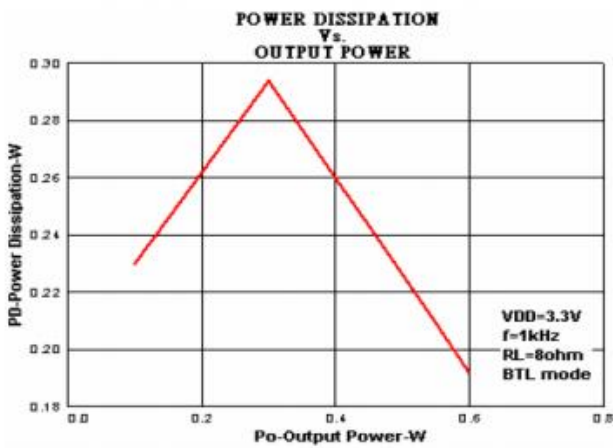

Figure 29.

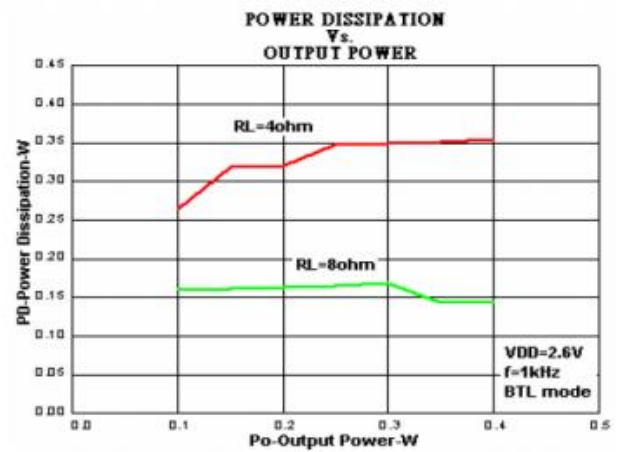

Figure 30.

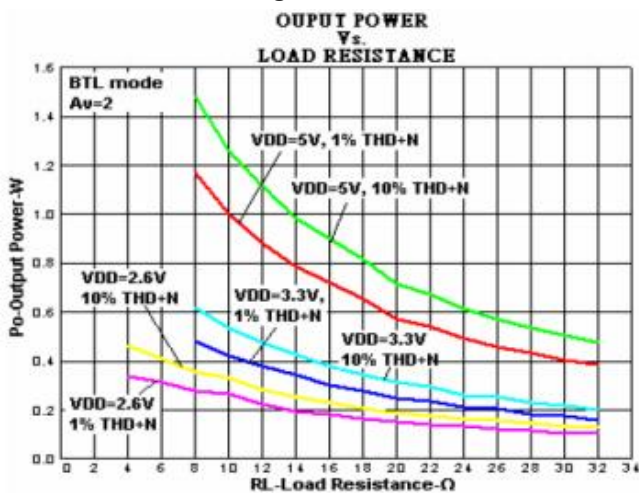

Figure 31.

Layout Considerations

As output power increases, interconnect resistance (PCB traces and wires) between the amplifier, load and power supply create a voltage drop. The voltage loss on the traces between the LM4890 and the load results in lower output power and decreased efficiency. Higher trace resistance between the supply and the LM4890 has the same effect as a poorly regulated supply, increase ripple on the supply line also reducing the peak output power. The effects of residual trace resistance increase as output current increases due to higher output power, decreased load impedance or both. To maintain the highest output voltage swing and corresponding peak output power, the PCB traces that connect the output pins to the load and the supply pins to the power supply should be as wide as possible to minimize trace resistance.

The use of power and ground planes will give the best THD+N performance. While reducing trace resistance, the use of power planes also creates parasitic capacitors that help to filter the power supply line.

The inductive nature of the transducer load can also result in overshoot on one or both edges, clamped by the parasitic diodes to GND and VDD in each case. From an EMI standpoint, this is an aggressive waveform that can radiate or conduct to other components in the system and cause interference. It is essential to keep the power and output traces short and well shielded if possible. Use of ground planes, beads, and micro-strip layout techniques are all useful in preventing unwanted interference.

As the distance from the LM4890 and the speaker increase, the amount of EMI radiation will increase since the output wires or traces acting as antenna become more efficient with length. What is acceptable EMI is highly application specific.

Ferrite chip inductors placed close to the LM4890 may be needed to reduce EMI radiation. The value of the ferrite chip is very application specific.

Physical Dimensions

DIP-8

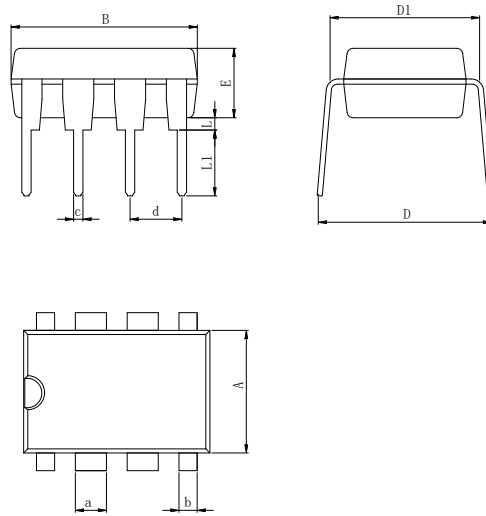

Dimensions In Millimeters(DIP-8)

Symbol:	A	B	D	D1	E	L	L1	a	b	c	d
Min:	6.10	9.00	8.40	7.42	3.10	0.50	3.00	1.50	0.85	0.40	2.54 BSC
Max:	6.68	9.50	9.00	7.82	3.55	0.70	3.60	1.55	0.90	0.50	

SOP-8 (150mil)

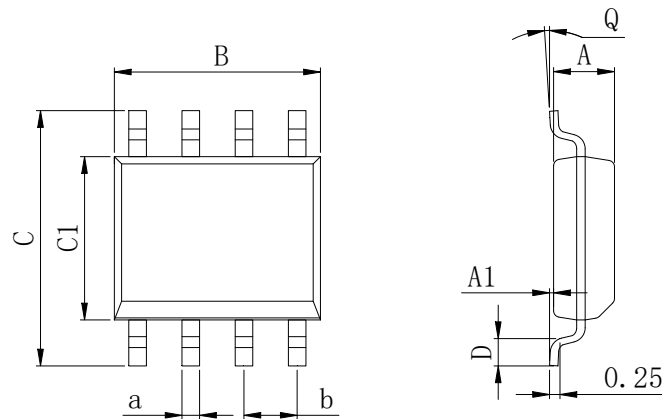

Dimensions In Millimeters(SOP-8)

Symbol:	A	A1	B	C	C1	D	Q	a	b
Min:	1.35	0.05	4.90	5.80	3.80	0.40	0°	0.35	1.27 BSC
Max:	1.55	0.20	5.10	6.20	4.00	0.80	8°	0.45	

Physical Dimensions

MSOP-8

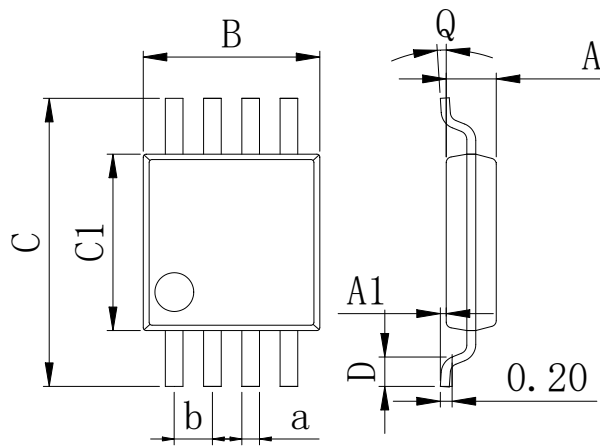

Dimensions In Millimeters(MSOP-8)									
Symbol:	A	A1	B	C	C1	D	Q	a	b
Min:	0.80	0.05	2.90	4.75	2.90	0.35	0°	0.25	0.65 BSC
Max:	0.90	0.20	3.10	5.05	3.10	0.75	8°	0.35	

IMPORTANT STATEMENT:

Huaguan Semiconductor reserves the right to change its products and services without notice. Before ordering, the customer shall obtain the latest relevant information and verify whether the information is up to date and complete. Huaguan Semiconductor does not assume any responsibility or obligation for the altered documents.

Customers are responsible for complying with safety standards and taking safety measures when using Huaguan Semiconductor products for system design and machine manufacturing. You will bear all the following responsibilities: select the appropriate Huaguan Semiconductor products for your application; Design, validate and test your application; Ensure that your application meets the appropriate standards and any other safety, security or other requirements. To avoid the occurrence of potential risks that may lead to personal injury or property loss.

Huaguan Semiconductor products have not been approved for applications in life support, military, aerospace and other fields, and Huaguan Semiconductor will not bear the consequences caused by the application of products in these fields.

The technical and reliability data (including data sheets), design resources (including reference designs), application or other design suggestions, network tools, safety information and other resources provided for the performance of semiconductor products produced by Huaguan Semiconductor are not guaranteed to be free from defects and no warranty, express or implied, is made. The use of testing and other quality control technologies is limited to the quality assurance scope of Huaguan Semiconductor. Not all parameters of each device need to be tested.

The documentation of Huaguan Semiconductor authorizes you to use these resources only for developing the application of the product described in this document. You have no right to use any other Huaguan Semiconductor intellectual property rights or any third party intellectual property rights. It is strictly forbidden to make other copies or displays of these resources. You should fully compensate Huaguan Semiconductor and its agents for any claims, damages, costs, losses and debts caused by the use of these resources. Huaguan Semiconductor accepts no liability for any loss or damage caused by infringement.