

SMAG Plastic-Encapsulate Diodes

Zener Diodes

Features

- P_d 1.0W
- V_z 3.0V-300V
- Range 5%

Applications

- Stabilizing Voltage

Marking

- 1SMA47XXA
XX : From 27 To 64 ($V_z < 100V$)
- 1SZ1XXXA
XXX : From 110 To 300 ($V_z > 100V$)

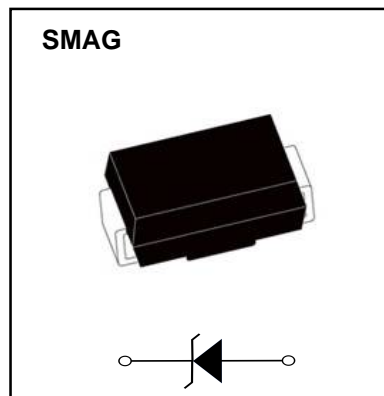

Limiting Values (Absolute Maximum Rating)

Item	Symbol	Unit	Conditions	Max
Power dissipation	P_d	W	$T_L = 75^\circ C$	1.0
Zener current	I_z	mA		P_v / V_z
Maximum junction temperature	T_j	$^\circ C$		-65 to +150
Storage temperature range	T_{stg}	$^\circ C$		-65 to +150
Forward voltage	V_F	V	$I_F = 200mA$	1.2

Electrical Characteristics (T_A=25°C unless otherwise noted)

Part Number	Nominal Zener Voltage		Maximum Zener Impedance			Maximum Reverse Leakage Current		Maximum DC Zener Current	Maximum Surge Current
	V _Z @ I _{ZT}	I _{ZT}	Z _{ZT} @ I _{ZT}	Z _{ZK} @ I _{ZK}	I _{ZK}	I _R @ V _R		I _{ZM}	I _{RM}
	(V)	(mA)	(Ω)	(Ω)	(mA)	(μA)	(V)	(mA)	(mApk)
1SMA4727A	3.0	83.0	10.0	400	1.00	150.0	1.0	274.0	1370
1SMA4728A	3.3	76.0	10.0	400	1.00	100.0	1.0	274.0	1370
1SMA4729A	3.6	69.0	10.0	400	1.00	100.0	1.0	251.0	1255
1SMA4730A	3.9	64.0	9.0	400	1.00	50.0	1.0	232.0	1160
1SMA4731A	4.3	58.0	9.0	400	1.00	20.0	1.0	210.0	1050
1SMA4732A	4.7	53.0	8.0	500	1.00	10.0	1.0	192.0	960
1SMA4733A	5.1	49.0	7.0	550	1.00	10.0	1.0	177.0	885
1SMA4734A	5.6	45.0	5.0	600	1.00	10.0	2.0	161.0	805
1SMA4735A	6.2	41.0	2.0	700	1.00	10.0	3.0	146.0	730
1SMA4736A	6.8	37.0	3.5	700	1.00	5.0	4.0	133.0	660
1SMA4737A	7.5	34.0	4.0	700	0.50	5.0	5.0	121.0	605
1SMA4738A	8.2	31.0	4.5	700	0.50	5.0	6.0	110.0	550
1SMA4739A	9.1	28.0	5.0	700	0.50	0.5	7.0	100.0	500
1SMA4740A	10.0	25.0	7.0	700	0.25	0.5	7.6	91.0	454
1SMA4741A	11.0	23.0	8.0	700	0.25	0.1	8.4	83.0	414
1SMA4742A	12.0	21.0	9.0	700	0.25	0.1	9.1	76.0	380
1SMA4743A	13.0	19.0	10.0	700	0.25	0.1	9.9	69.0	344
1SMA4744A	15.0	17.0	14.0	700	0.25	0.1	11.4	61.0	305
1SMA4745A	16.0	15.5	16.0	700	0.25	0.1	12.2	57.0	285
1SMA4746A	18.0	14.0	20.0	750	0.25	0.1	13.7	50.0	250
1SMA4747A	20.0	12.5	22.0	750	0.25	0.1	15.2	45.0	225
1SMA4748A	22.0	11.5	23.0	750	0.25	0.1	16.7	41.0	205
1SMA4749A	24.0	10.5	25.0	750	0.25	0.1	18.2	38.0	190
1SMA4750A	27.0	9.5	35.0	750	0.25	0.1	20.6	34.0	170
1SMA4751A	30.0	8.5	40.0	1000	0.25	0.1	22.8	30.0	150
1SMA4752A	33.0	7.5	45.0	1000	0.25	0.1	25.1	27.0	135
1SMA4753A	36.0	7.0	50.0	1000	0.25	0.1	27.4	25.0	125
1SMA4754A	39.0	6.5	60.0	1000	0.25	0.1	29.7	23.0	115
1SMA4755A	43.0	6.0	70.0	1500	0.25	0.1	32.7	22.0	110
1SMA4756A	47.0	5.5	80.0	1500	0.25	0.1	35.8	19.0	95
1SMA4757A	51.0	5.0	95.0	1500	0.25	0.1	38.8	18.0	90
1SMA4758A	56.0	4.5	110.0	2000	0.25	0.1	42.6	16.0	80
1SMA4759A	62.0	4.0	125.0	2000	0.25	0.1	47.1	14.0	70
1SMA4760A	68.0	3.7	150.0	2000	0.25	0.1	51.7	13.0	65
1SMA4761A	75.0	3.3	175.0	2000	0.25	0.1	56.0	12.0	60
1SMA4762A	82.0	3.0	200.0	3000	0.25	0.1	62.2	11.0	55
1SMA4763A	91.0	2.8	250.0	3000	0.25	0.1	69.2	10.0	50
1SMA4764A	100.0	2.5	350.0	3000	0.25	0.1	76.0	9.0	45
1SZ1110A	110.0	2.3	450.0	4000	0.25	0.1	83.6	8.6	40
1SZ1120A	120.0	2.0	550.0	4500	0.25	0.1	91.2	7.8	37
1SZ1130A	130.0	1.9	700.0	5000	0.25	0.1	98.8	7.0	34
1SZ1150A	150.0	1.7	1000.0	6000	0.25	0.1	114.0	6.4	30
1SZ1160A	160.0	1.6	1100.0	6500	0.25	0.1	121.6	5.8	28
1SZ1180A	180.0	1.4	1200.0	7000	0.25	0.1	136.8	5.2	25
1SZ1200A	200.0	1.2	1900.0	9990	0.25	0.1	152.0	4.7	22
1SZ1220A	220.0	1.0	1600.0	8000	0.25	0.1	167.2	4.0	20
1SZ1240A	240.0	0.9	1800.0	8500	0.25	0.1	182.4	3.8	19
1SZ1250A	250.0	0.9	2000.0	9000	0.25	0.1	190.0	3.6	18
1SZ1270A	270.0	0.8	2100.0	9000	0.25	0.1	205.0	3.3	16
1SZ1300A	300.0	0.8	2300.0	9500	0.25	0.1	228.0	3.0	15

Typical Characteristics

FIG1: Maximum Continuous Power Dissipation

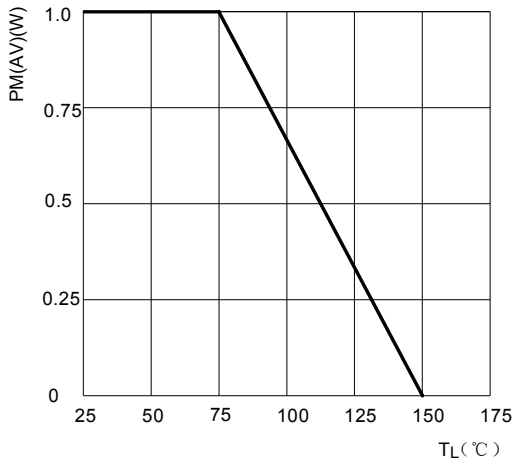

FIG2: Typical Zener Impedance

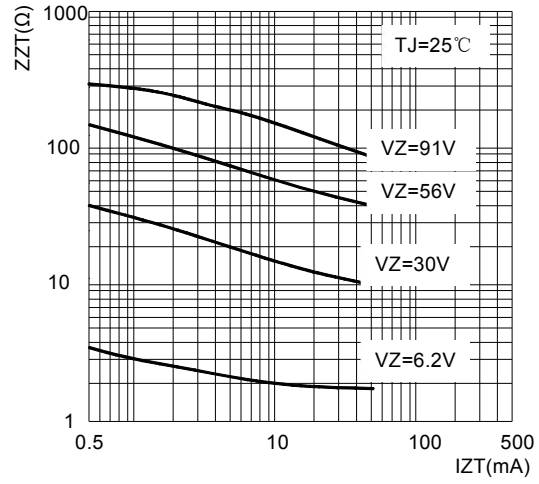

FIG3: Typical Temperature Coefficients

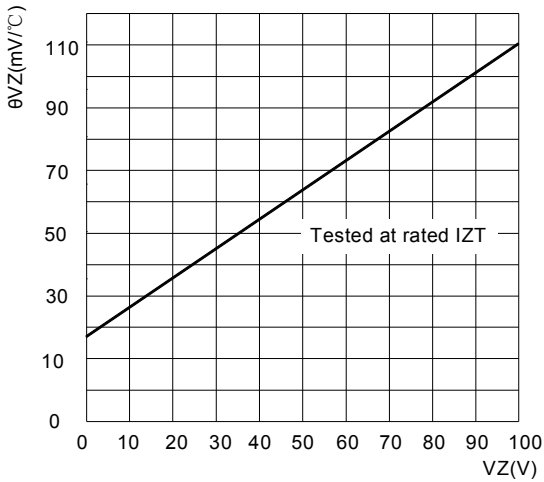

FIG4: Typical Instantaneous Forward Characteristics for SMA4763A

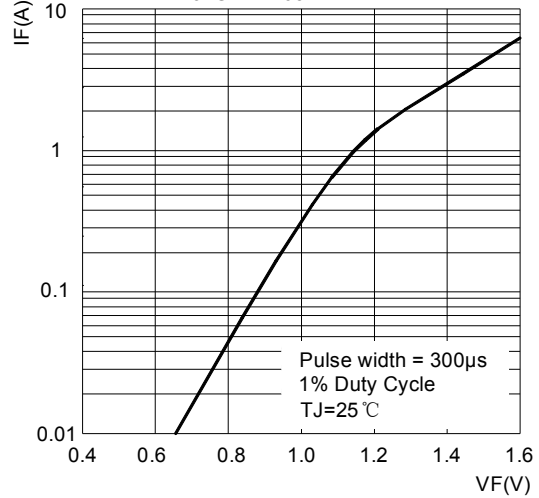
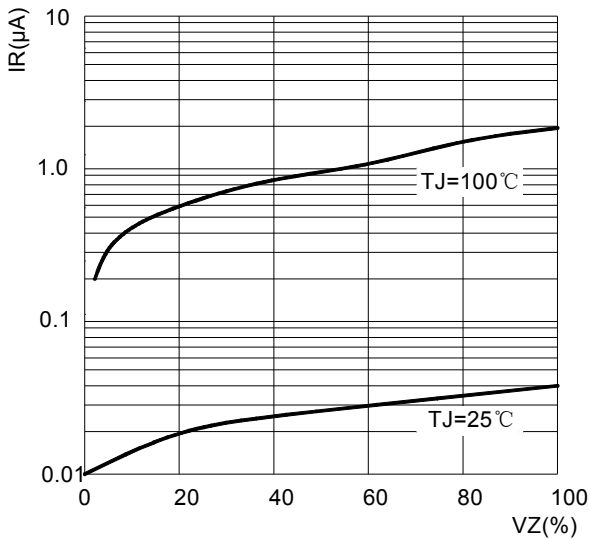
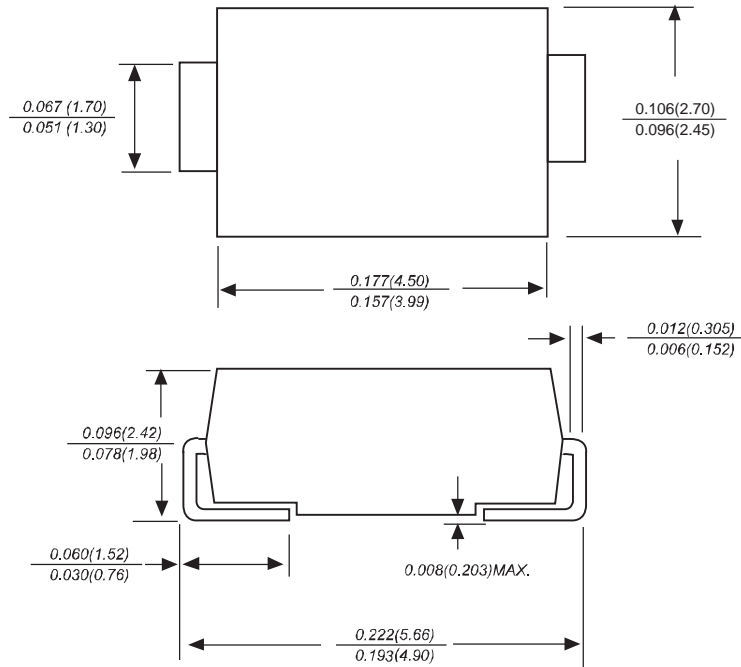

FIG5: Typical Reverse Characteristics



SMAG Package Outline Dimensions



Dimensions in inches and (millimeters)

SMAG Suggested Pad Layout

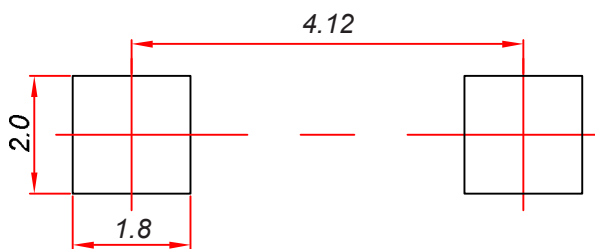

Note:

1. Controlling dimension: in millimeters.
2. General tolerance: ± 0.05 mm.
3. The pad layout is for reference purposes only.

NOTICE

JSHD reserve the right to make modifications, enhancements, improvements, corrections or other changes without further notice to any product herein. JSHD does not assume any liability arising out of the application or use of any product described herein.

Reel Taping Specifications For Surface Mount Devices- SMAG

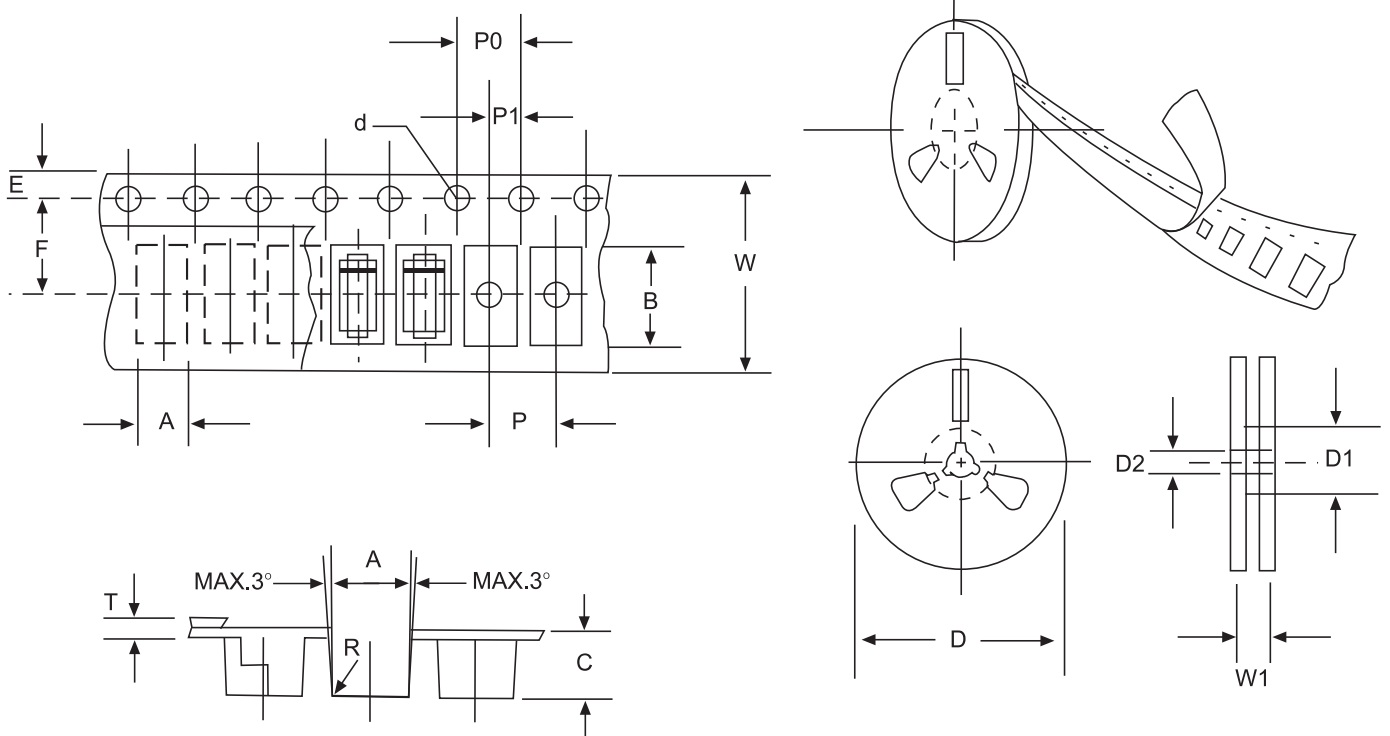

FIG : CONFIGURATION OF SURFACE MOUNTED DEVICES TAPING

ITEM	SYMBOL	SMAG mm(inch)
Carrier width	A	2.79±0.1(0.110±0.004)
Carrier length	B	5.33±0.1(0.210±0.004)
Carrier depth	C	2.36±0.1(0.093±0.004)
Sprocket hole	d	1.55±0.05(0.061±0.002)
Reel outside diameter	D	279±2.0 (11± 0.079)
Reel inner diameter	D1	75±1.0 (2.95 ±0.039)
Feed hole diameter	D2	13±0.5(0.512±0.020)
Sprocket hole position	E	1.75±0.1(0.069±0.004)
Punch hole position	F	5.5±0.05(0.217±0.002)
Punch hole pitch	P	4.0±0.1(0.157±0.004)
Sprocket hole pitch	P0	4.0±0.1(0.157±0.004)
Embossment center	P1	2.0±0.1(0.079±0.004)
Total tape thickness	T	0.28±0.02(0.011 ±0.0008)
Tape width	W	12.0±0.2(0.472±0.008)
Reel width	W1	16.8±2.0(0.661±0.079)

NOTE: Devices are packed in accordance with EIA standard RS-481-A and specification given above.