



# 广西中立电子有限公司

## 样品承认书

Product specification



本公司已通过 ISO 9001:2015 质量管理体系认证  
本公司已通过 ISO 14001:2015 环境管理体系认证

2023

|                               |  |
|-------------------------------|--|
| 产品类型<br>Description           | 压电式无源蜂鸣器<br>Piezoelectric passive buzzer |
| 客户名称/代码<br>Customer Name/Code | 10347                                    |
| 客户型号/料号<br>Customer Part No.  |  |
| 中立型号<br>ZL Model No.          | ZL-YDW12055-4005PA-7.5 旧丝印               |
| 样品日期<br>Sample Date           | 2023-4-6 仅承认书                            |
| 中立料号<br>ZL Part No.           | 80103154                                 |

### 客户承认签署 Customer's Approved Signature

| 核准/Approved | 审核/Checked | 经办/Designed |
|-------------|------------|-------------|
|             |            |             |

### 中立确认签署 ZHONGLI confirmation and signature

| 核准/Approved | 审核/Checked | 经办/Designed |
|-------------|------------|-------------|
|             |            |             |

请承认后请签回一份! Please acknowledge and sign back one!



# 广西中立电子有限公司

## 样品承认书

型号 Model No.: ZL-YDW12055-4005PA-7.5 旧丝印

|    |   |                                 |
|----|---|---------------------------------|
| 1  | 额定频率 Resonance Frequency (Hz)                               | 4000                            |
| 2  | 额定电压 Rated Voltage (Vp-p)                                   | 5                               |
| 3  | 最大电压 Max. Input Voltage (Vp-p)                              | 30                              |
| 4  | 电容量 Capacitance at 120Hz (nF)                               | 12±40%                          |
| 5  | 在 10cm 处测试声压值 Sound Output at 10cm (dB)                     | ≥80 at 4000Hz Square Wave 5Vp-p |
| 6  | 消耗电流 Current Consumption (mA)                               | ≤10 at 4000Hz Square Wave 5Vp-p |
| 7  | 工作温度 Operating Temperature (°C)                             | -20~+70                         |
| 8  | 储存温度 Storage Temperature (°C)                               | -30~+80                         |
| 9  | 单品重量 (参考典型值) Weight Typical value(g)                        | 0.60±0.2                        |
| 10 | 外壳材料 Housing Material                                       | 黑色 Black PBT                    |
| 11 | 符合环保法规 Compliance with environmental protection regulations | RoHS, Reach                     |

| 蜂鸣器焊接方法<br>Buzzer Soldering process | Soldering Parameter |               |             |
|-------------------------------------|---------------------|---------------|-------------|
|                                     | 温度 Temp.(°C)        | 时间 Time(Sec.) | 可焊接次数 Times |
| ★波峰焊 Wave soldering                 | 260±5               | 4~6           | 2~3         |
| ★手工焊 Manual soldering               | 350±10              | 2~5           | 2~3         |

带★号为中立推荐的焊接方法 Remark:★ ZHONGLI Recommended Soldering Process

外形尺寸图 (单位: 毫米) DIMENSIONS (UNIT: mm)

未标注公差尺寸按±0.5mm Dimension without tolerance shall be ± 0.5mm

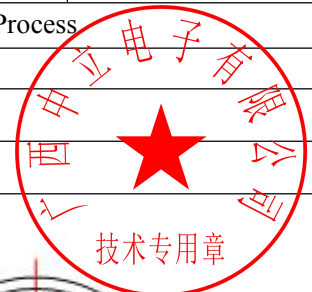
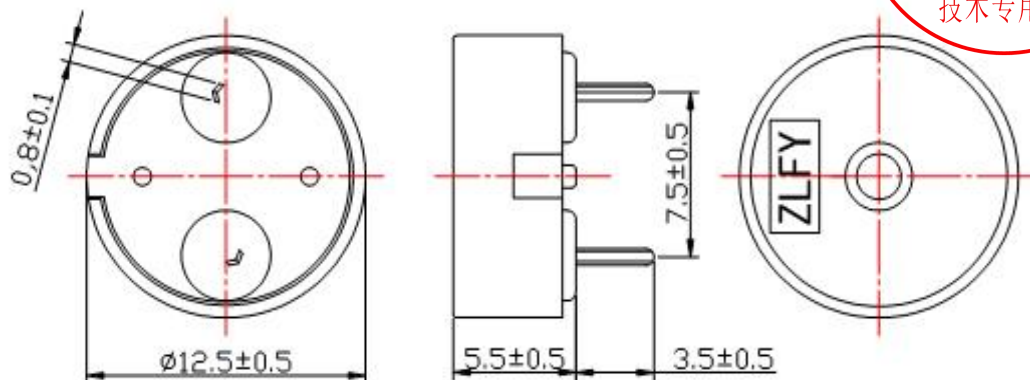



# 广西中立电子有限公司

## 样品承认书

型号 Model No.: ZL-YDW12055-4005PA-7.5

### 测试方法 TEST METHOD

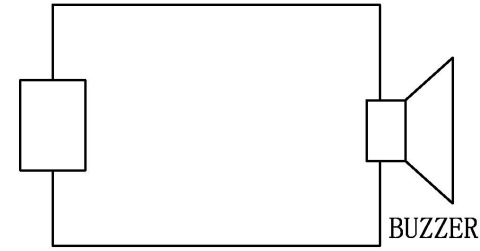

Acoustic Component Computer Test System

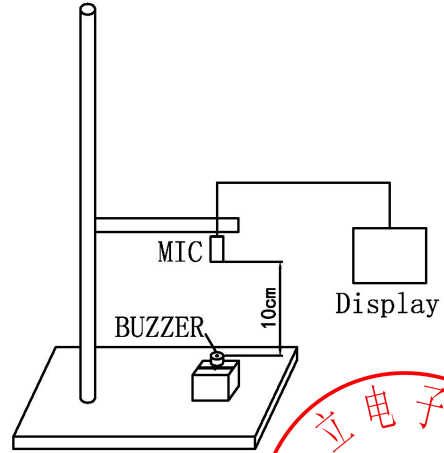

Acoustic Component Computer Test System

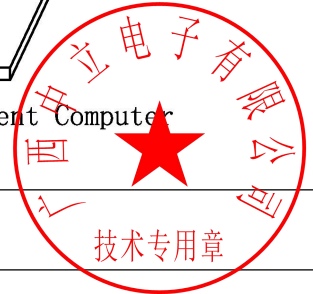

### 频响特性曲线 (此为典型值仅作为参考)

### FREQUENCY RESPONSE (typical value for reference only)

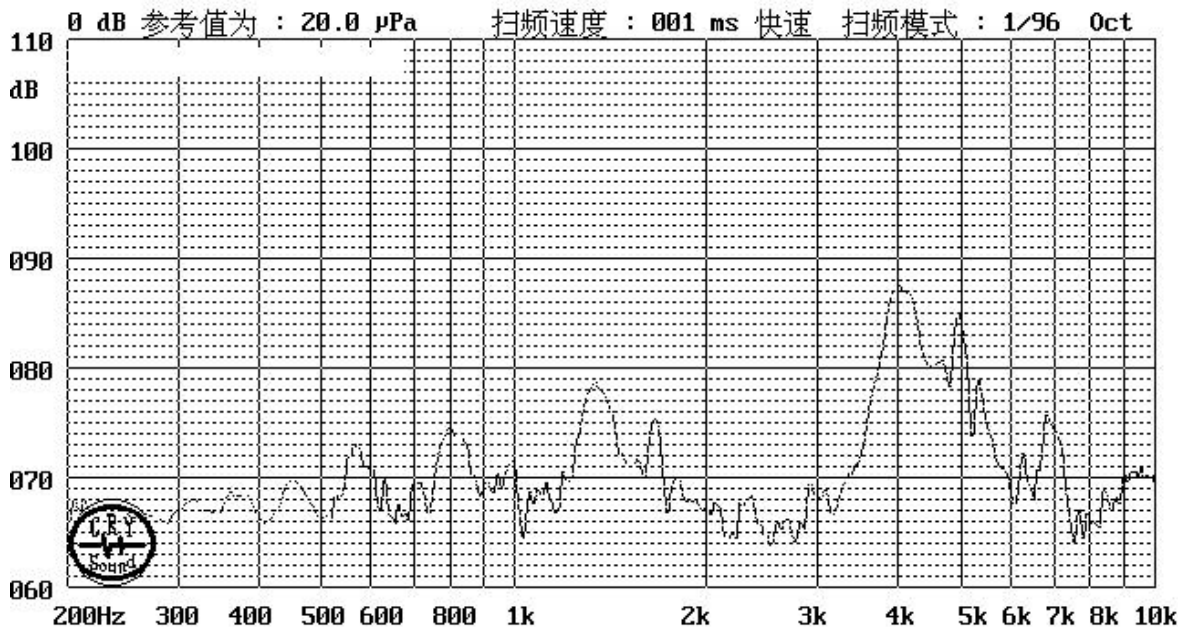



# 广西中立电子有限公司

## 样品承认书

型号 Model No.: ZL-YDW12055-4005PA-7.5

### 可靠性测试 RELIABLE TEST

| NO. | 项目 ITEM  | 测试条件<br>TESTING CONDITION   | 试验后要求<br>VARIATION AFTER TEST   |
|-----|--|---|---|
| 1   | 湿热<br>Humidity                                 | 将蜂鸣器置于温度在 $50 \pm 5^\circ\text{C}$ ，相对湿度在 90~95% 中，保持 48 小时后，在常温下恢复 2 小时再测试。<br>Place the buzzer in a temperature of $50 \pm 5^\circ\text{C}$ and a relative humidity of 90~95% for 48 hours, Restore at room temperature for 2 hours before testing.                             | 1.测试后性能指标应满足承认书要求<br>1.All specifications must be satisfied after the test.<br>2.试验中及试验后声压级允许变化: $\pm 10\text{dB}$ 。<br>2.Allowable change of Sound Pressure Level during and after test: $\pm 10\text{dB}$ . |
| 2   | 高温测试<br>High temp.                             | 将蜂鸣器放置在 $+80 \pm 2^\circ\text{C}$ 中，保持 48 小时后，在常温下恢复 2 小时再测试。<br>Place the buzzer in $+80 \pm 2^\circ\text{C}$ , keep it for 48 hours, Restore at room temperature for 2 hours before testing.  |   |
| 3   | 低温测试<br>Low temp.                              | 将蜂鸣器放置在 $-30 \pm 2^\circ\text{C}$ 中，保持 48 小时后，在常温下恢复 2 小时再测试。<br>Place the buzzer in $-30 \pm 2^\circ\text{C}$ , keep it for 48 hours, Restore at room temperature for 2 hours before testing.  |   |
| 4   | 温度循环测试<br>Temperature Cycling                  | 将蜂鸣器在 $-30^\circ\text{C}$ 暴露 30min, 在 $+80^\circ\text{C}$ 暴露 30min, 五次循环后, 在常温下恢复 2 小时再测试。<br>$-30 \pm 2^\circ\text{C}$ , 30minutes<br>room temp. 30minutes<br>$+80 \pm 2^\circ\text{C}$ , 30 minutes<br>room temp. 30 minutes<br>5 cycles  |   |
| 5   | 跌落<br>Drop test                                | 将蜂鸣器放置在水平位置, 从 75cm 高度自由跌落到 10mm 硬木板上, 跌落 3 次后, 检查外观并测量电性能。<br>Place the buzzer in a horizontal position and drop it freely from a height of 75 cm to a 10 mm hardwood board. After three drops, check the appearance and measure the electrical performance                      |   |
| 6   | 振动<br>Vibration test                           | 将蜂鸣器置于 10~55Hz、振幅在 1.0mm、X Y Z 轴线方向上振动 0.5 小时<br>Make the test for the directions of X Y and Z (total 0.5 hours).<br>To-and-fro. sweep time (from 10 to 55 Hz and then from 55 to 10Hz ) under single amplitude of 1.0mm is 1 minute.   |   |
| 7   | 焊锡耐热性<br>Solder heat resistance                | 将产品针脚放置在 $260 \pm 5^\circ\text{C}$ 的锡炉里, 持续 $10 \pm 0.5$ 秒, 本体距熔融焊料 2.0mm。<br>The part leads (pins) shall be immersed in molten solder maintained at $260 \pm 5^\circ\text{C}$ for a period of $10 \pm 0.5$ seconds, The distance between the body and the molten solder is 2.0mm |   |
| 8   | 终端强度<br>拉力试验<br>Terminal Strength Pulling Test | 向每个端子施加 9.8N 的轴向力 5 秒。不可见损坏和切断。The force of 9.8N is applied to each terminal in axial direction for 5 seconds.No visible damage and cutting off.  |   |





# 广西中立电子有限公司

## 产品包装示意图

型号 Model No.: ZL-YDW12055-4005PA-7.5

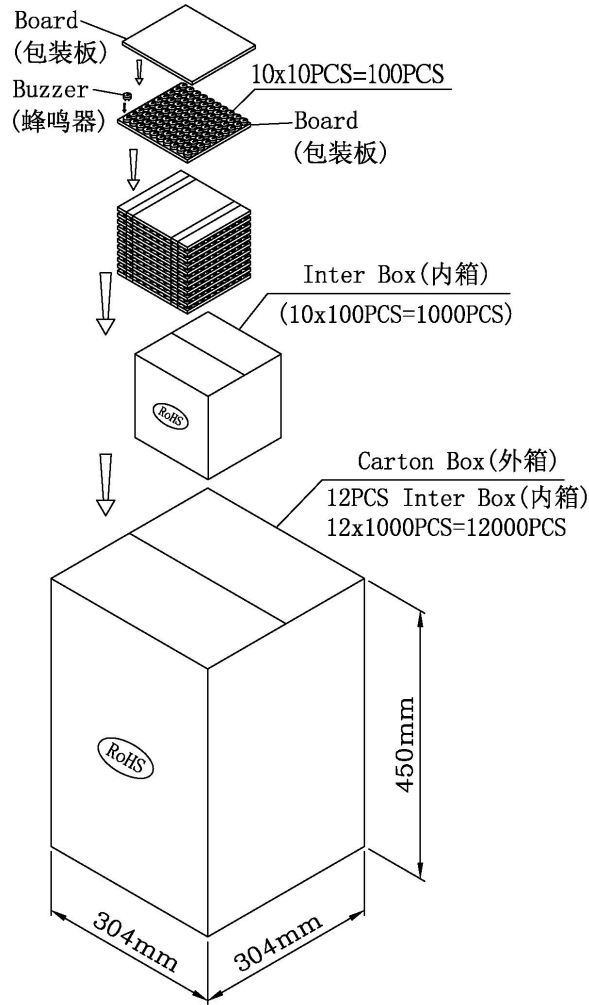

|            |               |                     |
|------------|---------------|---------------------|
| Board      | 135x135x6mm   | 1x100PCS=100PCS     |
| Inter Box  | 142x142x140mm | 10x100PCS=1000PCS   |
| Carton Box | 304x304x450mm | 12x1000PCS=12000PCS |

### 产品使用注意事项:

1. 请勿对蜂鸣器施加超出使用范围以外的电压。
2. 本产品为开放式设计，不符合防水/防胶渗漏要求。
3. 在有腐蚀性气体的地方长时间使用会将蜂鸣器部品腐蚀而不能正常工作。
4. 蜂鸣器的声压性能会随电压或电流大小负荷而改变，应满足电压或电流要求。
5. 避免出音孔前方有障板或被遮蔽会导致工作不稳定。
6. 蜂鸣器应在良好包装下储存，以避免受潮、生锈、针脚端氧化。

### Precautions :

1. Do not apply voltage beyond the range of use of the buzzer.
2. This product is of open design and does not meet the requirements of waterproof/glue leakage.
3. Prolonged use in a place with corrosive gas will corrode the buzzer components and prevent them from working properly.
4. The sound pressure performance of the buzzer will change with the voltage or current load, and it should meet the voltage or current requirements.
5. Avoid that there is a baffle in front of the sound hole or it is covered, which will lead to unstable operation.
6. The buzzer should be stored in a good package to avoid moisture, rust and oxidation of the pin end.

Tel: +86-18988588885

Web: <http://www.zlfy.com.cn>

总部地址: 广东省中山市东凤镇同乐工业园创源路12号

分部地址: 广西大新县桃城镇呗依创业园7号楼



# 广西中立电子有限公司

## 样品性能测试报告

| 型号 Model No.: ZL-YDW12055-4005PA-7.5 |                |   |               |                    |                   |              |              |  |
|--------------------------------------|----------------|---|---------------|--------------------|-------------------|--------------|--------------|--|
| 数量 Quantity                          |                |   |               | 测试数据 Testing data  |                   |              |              |  |
| 10PCS                                |                |   |               | 10PCS              |                   |              |              |  |
| 测试条件<br>Testing conditions           |                | 5Vp-p, 方波信号/Square wave signal, 4000Hz, 在 10cm 处测试 /Tested at 10cm height   |               |                    |                   |              |              |  |
| 技术要求<br>Technical requirement        |                | 声压级 /Sound pressure level $\geq 80\text{dB}$ , 电流 /Current $\leq 10\text{mA}$ , 电容/Capacitance: $12 \pm 40\% \text{nF}$ |               |                    |                   |              |              |  |
| 检测项目<br>Test items                   | 声压<br>SPL (dB) | 电流<br>I (mA)  | 电容<br>C (nF)  | 检测项目<br>Test items | 声压<br>SPL (dB)    | 电流<br>I (mA) | 电容<br>C (nF) |  |
| 记录 Record                            | 1              | 85  | 0.67          | 11.9               | 记录 Record         | 26           |              |  |
|                                      | 2              | 85  | 0.70          | 12.3               |                   | 27           |              |  |
|                                      | 3              | 86  | 0.67          | 11.3               |                   | 28           |              |  |
|                                      | 4              | 85  | 0.75          | 10.5               |                   | 29           |              |  |
|                                      | 5              | 85  | 0.65          | 11.7               |                   | 30           |              |  |
|                                      | 6              | 83  | 0.67          | 12.4               |                   | 31           |              |  |
|                                      | 7              | 86  | 0.77          | 11.4               |                   | 32           |              |  |
|                                      | 8              | 85  | 0.78          | 10.5               |                   | 33           |              |  |
|                                      | 9              | 85  | 0.72          | 11.2               |                   | 34           |              |  |
|                                      | 10             | 84  | 0.70          | 12.4               |                   | 35           |              |  |
|                                      | 11             |   |               |                    |                   | 36           |              |  |
|                                      | 12             |   |               |                    |                   | 37           |              |  |
|                                      | 13             |   |               |                    |                   | 38           |              |  |
|                                      | 14             |   |               |                    |                   | 39           |              |  |
|                                      | 15             |   |               |                    |                   | 40           |              |  |
|                                      | 16             |   |               |                    |                   | 41           |              |  |
|                                      | 17             |   |               |                    |                   | 42           |              |  |
|                                      | 18             |   |               |                    |                   | 43           |              |  |
|                                      | 19             |   |               |                    |                   | 44           |              |  |
|                                      | 20             |   |               |                    |                   | 45           |              |  |
|                                      | 21             |   |               |                    |                   | 46           |              |  |
|                                      | 22             |   |               |                    |                   | 47           |              |  |
|                                      | 23             |   |               |                    |                   | 48           |              |  |
|                                      | 24             |   |               |                    |                   | 49           |              |  |
|                                      | 25             |   |               |                    |                   | 50           |              |  |
| 备注 Remarks                           |                |   |               |                    |                   |              |              |  |
| 结论<br>Conclusion                     |                | 合格<br>Pass  | 测试<br>Testing | ZL-511             | 审核<br>Examination | ZL-001       |              |  |

