

Silicon Carbide Power MOSFET 1200V, 55A, 40m Ω

General Description

This product family offers state of the art performance. It is designed for high frequency applications here high efficiency and high reliability are required.

Features

- High Blocking Voltage
- High Frequency Operation
- Low on-resistance
- Fast intrinsic diode with low reverse recovery

Applications

- Motor Drives
- Solar / Wind Inverters
- EV Charging Station
- AC/DC converters
- DC/DC converters
- Uninterruptable power supplies

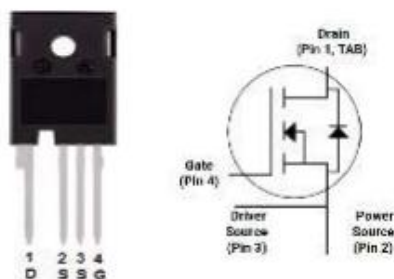

TO-247-4 Pin definition

Benefits

- Higher System Efficiency
- Parallel Device Convenience without thermal runaway
- High Temperature Application
- Hard Switching & Higher Reliability
- Easy to drive

Key performance parameters

Type	V_{DS}	I_D $T_C=25^\circ\text{C}$	$R_{DS(ON)}$
KN3M0040120Q	1200V	55A	40m Ω

Caution: This device is sensitive to electrostatic discharge .Users should follow ESD handing procedures.

Maximum Ratings

$T_C=25^{\circ}\text{C}$, unless otherwise specified

Parameter	Symbol	Test conditions	Value	Unit
Drain - Source Voltage	V_{DSmax}	$V_{GS} = 0V, I_D=100\mu A$	1200	V
Gate - Source Voltage (dynamic)	V_{GSmax}	AC ($f>1\text{ Hz}$)	-10/+25	V
Gate - Source Voltage (static)	V_{GSop}	static	-5/+20	V

Maximum Ratings

$T_C=25^{\circ}\text{C}$, unless otherwise specified

Parameter	Symbol	Value	Unit
Continuous Drain Current: $V_{GS} = 20V$ $T_C = 25^{\circ}\text{C}$ $T_C = 100^{\circ}\text{C}$	I_D	55 39	A
Pulsed Drain Current: $T_C = 25^{\circ}\text{C}$	$I_{D(pulse)}$	117	A
Short Circuit Capability : $V_{DD} = 800V$ $V_{GS} = 20V$	tsc	3	μS
Short Circuit Capability : $V_{DD} = 800V$ $V_{GS} = 20V$	I_{DS}	600	A
Total power dissipation : $T_C = 25^{\circ}\text{C}$	P_D	300	W
Operating Junction Temperature :	T_j	-55 to 175	$^{\circ}\text{C}$
Storage Temperature :	T_{stg}	-55 to 150	$^{\circ}\text{C}$

Thermal Characteristics

Parameter	Symbol	Condition	Typ	Max	Unit
Thermal Resistance (per device)	$R_{th(j-c)}$	junction-case	0.35	0.5	$^{\circ}\text{C/W}$

Caution: This device is sensitive to electrostatic discharge .Users should follow ESD handing procedures.

Electrical Characteristic

$T_C = 25^\circ\text{C}$, unless otherwise specified

Parameter	Symbol	Value			Unit	Test Condition
		Min.	Typ.	Max.		
Drain-Source Breakdown Voltage	$V_{(BR)DSS}$	1200			V	$V_{GS} = 0V$ $I_D = 100\mu A$
Gate Threshold Voltage	$V_{GS(th)}$	1.8	3.5 2.6 2.5	3.9	V	$V_{DS} = V_{GS}$ $I_D = 10mA$ $T_J = 150^\circ\text{C}$ $T_J = 175^\circ\text{C}$
Zero Gate Voltage Drain Current	I_{DSS}	0	5	100	μA	$V_{DS} = 1200V$ $V_{GS} = 0V$
Gate-Source Leakage Current	I_{GSS}	0 -200	10 -10	200 0	nA	$V_{GS} = 20V$ $V_{DS} = 0V$ $V_{GS} = -5V$ $V_{DS} = 0V$
Drain-Source On-State Resistance	$R_{DS(on)}$		40 61 69	44	m Ω	$V_{GS} = 20V$ $I_D = 40 A$ $T_J = 150^\circ\text{C}$ $T_J = 175^\circ\text{C}$
Transconductance	gfs		22 20 19		S	$V_{GS} = 20V$ $I_D = 40 A$ $T_J = 150^\circ\text{C}$ $T_J = 175^\circ\text{C}$
Input capacitance	C_{iss}		2930		pF	$V_{DS} = 1000V$ $V_{GS} = 0V$ $f = 1MHz$
Output capacitance	C_{oss}		149			
Reverse transfer capacitance	C_{rss}		9			
Coss Stored Energy	E_{oss}		87		μJ	
Total gate charge	Q_g		145		nC	$V_{DS} = 800V$ $V_{GS} = -5V / 20V$ $I_D = 40 A$
Gate-source charge	Q_{gs}		43			
Gate-drain charge	Q_{gd}		73			
Internal gate input resistance	$R_{g(int)}$		2		Ω	$f = 1MHz$ $I_D = 0A$
Turn-On Switching Energy	E_{ON}		609		μJ	$V_{DS} = 800V$ $V_{GS} = -5V / 20V$ $I_D = 40A$ $R_{G(ext)} = 1.5 \Omega$ $L = 450\mu H$
Turn-Off Switching Energy	E_{OFF}		439			

Caution: This device is sensitive to electrostatic discharge .Users should follow ESD handling procedures.

Turn-On Delay Time	$t_{d(on)}$		22		ns	$V_{DS} = 800V$ $V_{GS} = -5V/20V$ $I_D = 40A$ $R_{G(ext)} = 1.5 \Omega$ $L = 450\mu H$
Rise Time	t_r		34			
Turn-Off Delay Time	$t_{d(off)}$		36			
Fall Time	t_f		20			
Avalanche Capability	E_{AS}		676		mJ	$V_{DD} = 100V$ $V_{GS} = 20V$ $L = 2mH$
	I_{Av}		26		A	

Reverse Diode Characteristics

$T_C = 25^\circ C$, unless otherwise specified

Parameter	Symbol	Value			Unit	Test Condition
		Min.	Typ.	Max.		
Diode Forward Voltage	V_{SD}		3.9 3.5 3.4		V	$V_{GS} = -5V$ $I_{SD} = 20A$ $T_J = 150^\circ C$ $T_J = 175^\circ C$
Continuous Diode Forward Current	I_S		70		A	$V_{GS} = -5V$
Reverse Recovery time	t_{rr}		20		ns	$V_{GS} = -5V$ $I_{SD} = 40A$ $V_R = 800V$ $di/dt = 4000 A/\mu s$
Reverse Recovery Charge	Q_{rr}		375		nC	
Peak Reverse Recovery Current	I_{rrm}		31		A	

Caution: This device is sensitive to electrostatic discharge .Users should follow ESD handing procedures.

Typical Performanc

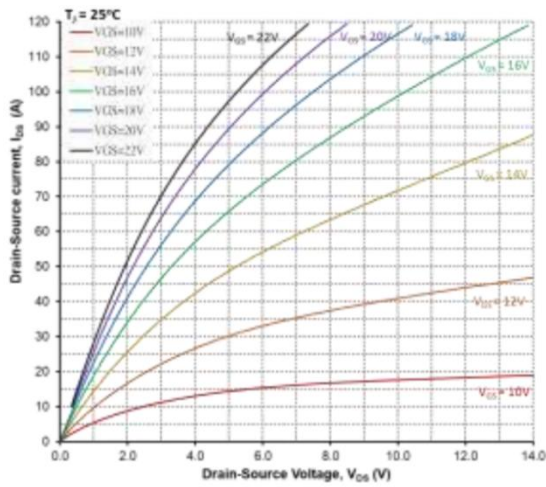

Figure 1. Output Characteristics, $T_J = 25^\circ\text{C}$

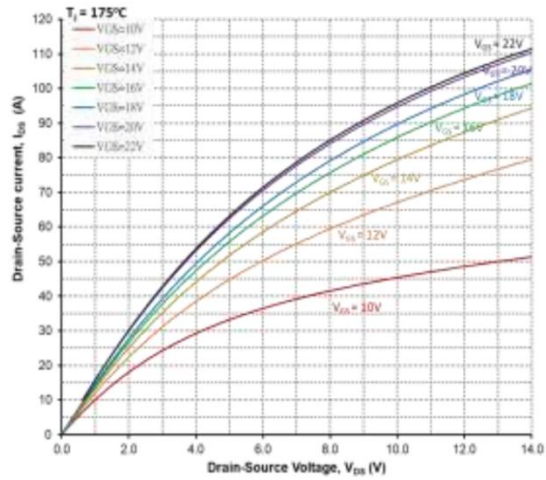

Figure 2. Output Characteristics, $T_J = 175^\circ\text{C}$

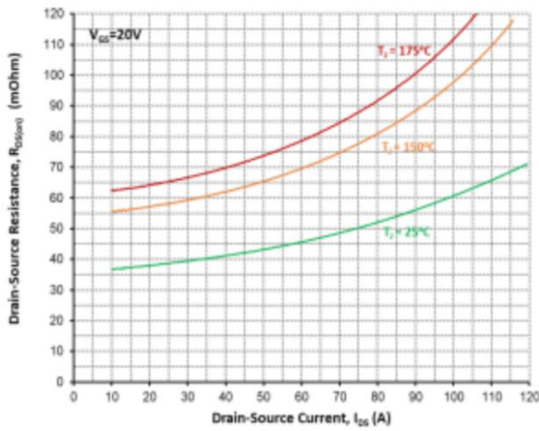

Figure 3. On-Resistance vs. Drain Current For Various Temperatures

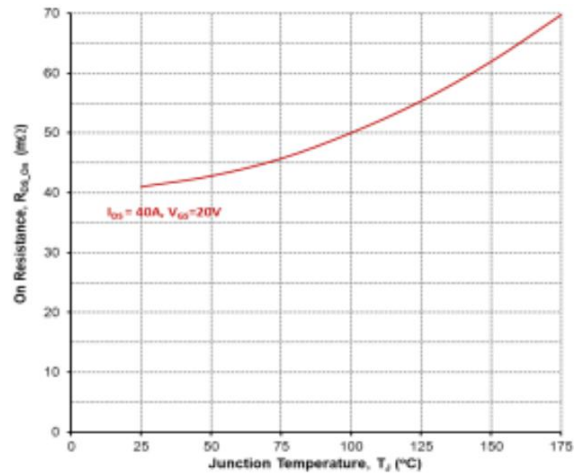

Figure 4. On-Resistance vs. Temperature

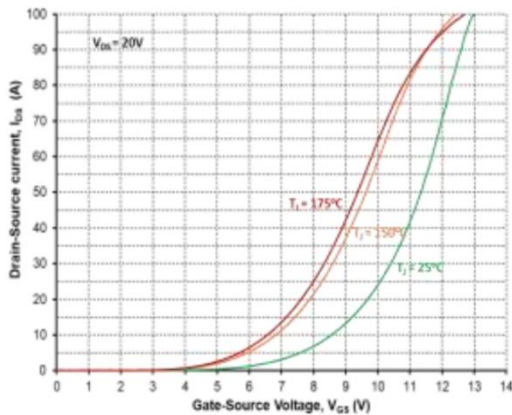

Figure 5. Transfer Characteristic For Various Junction Temperatures

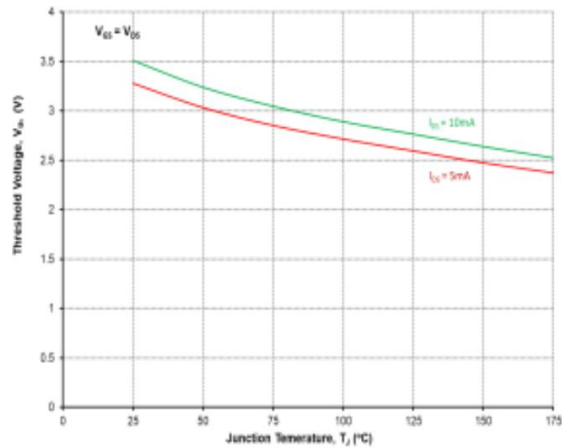

Figure 6. Threshold Voltage vs. Temperature

Caution: This device is sensitive to electrostatic discharge .Users should follow ESD handling procedures.

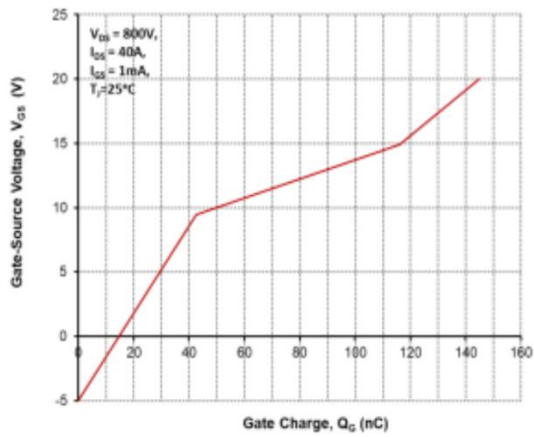

Figure 7. Gate Charge Characteristics

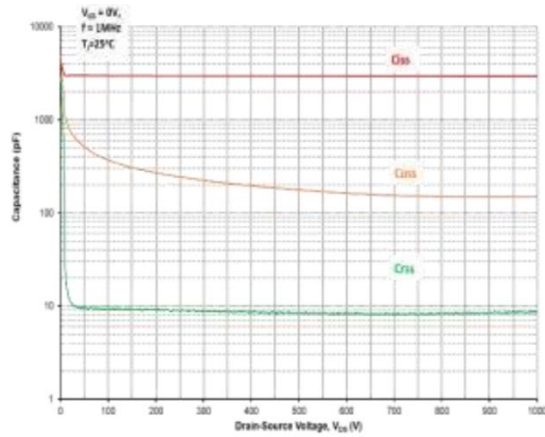

Figure 8. Capacitances vs. Drain-Source Voltage (0-1000V)

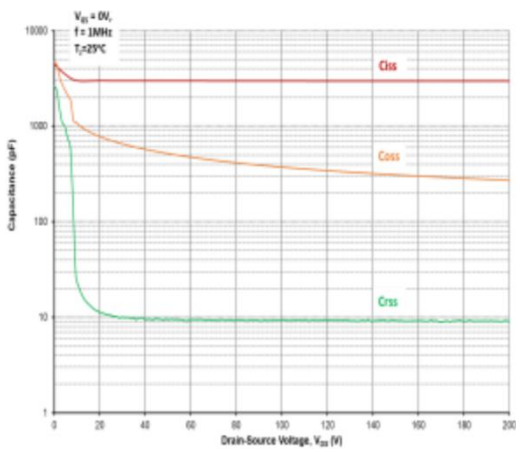

Figure 9. Capacitances vs. Drain-Source Voltage (0-200V)

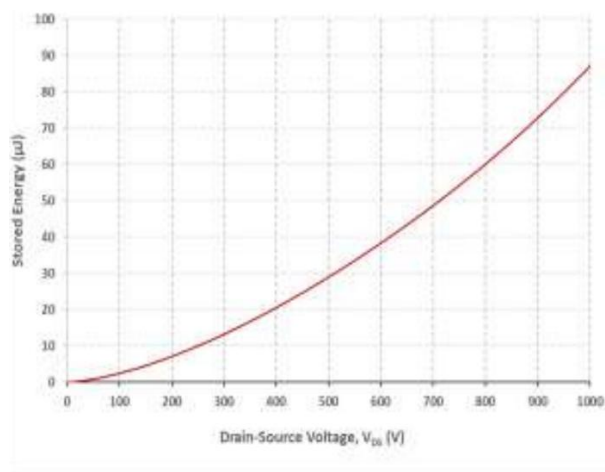

Figure 10. Output Capacitor Stored Energy

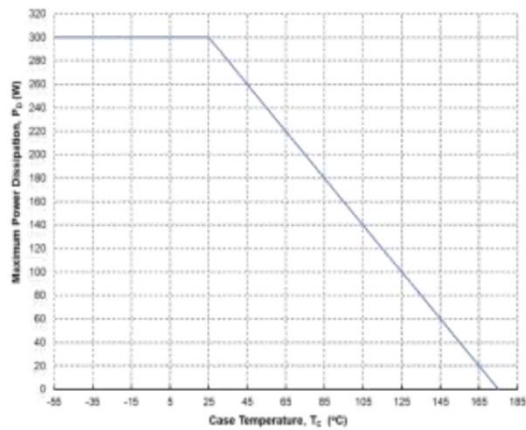

Figure 11. Maximum Power Dissipation Derating vs. Case Temperature

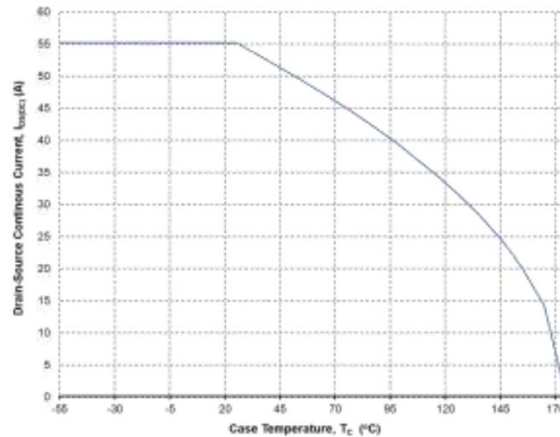

Figure 12. Continuous Drain Current Derating vs. Case Temperature

cedures.

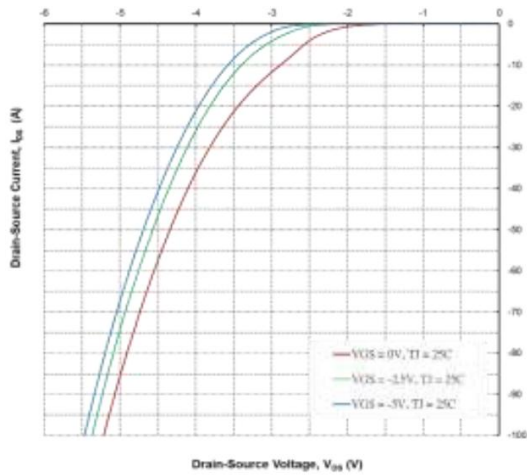

Figure 13. Body Diode Characteristics @ 25°C

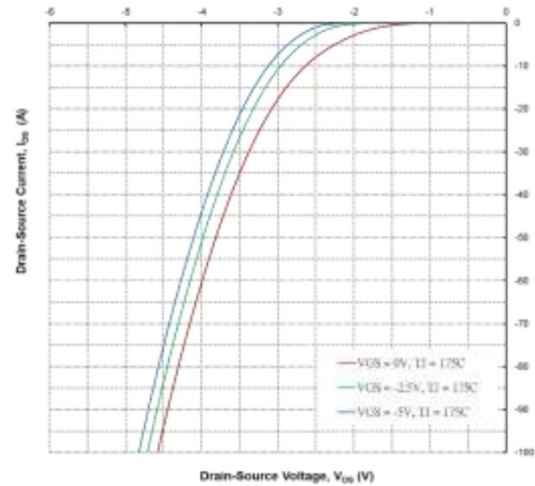

Figure 14. Body Diode Characteristics @ 175°C

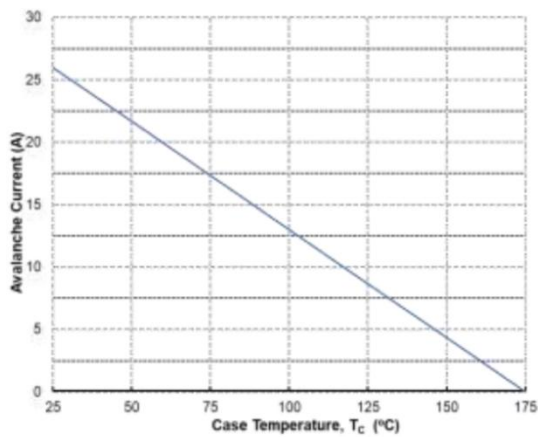

Figure 15. Single Avalanche vs. Temperature

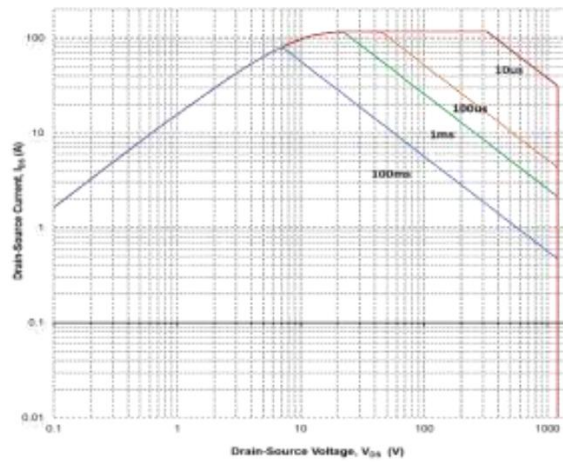
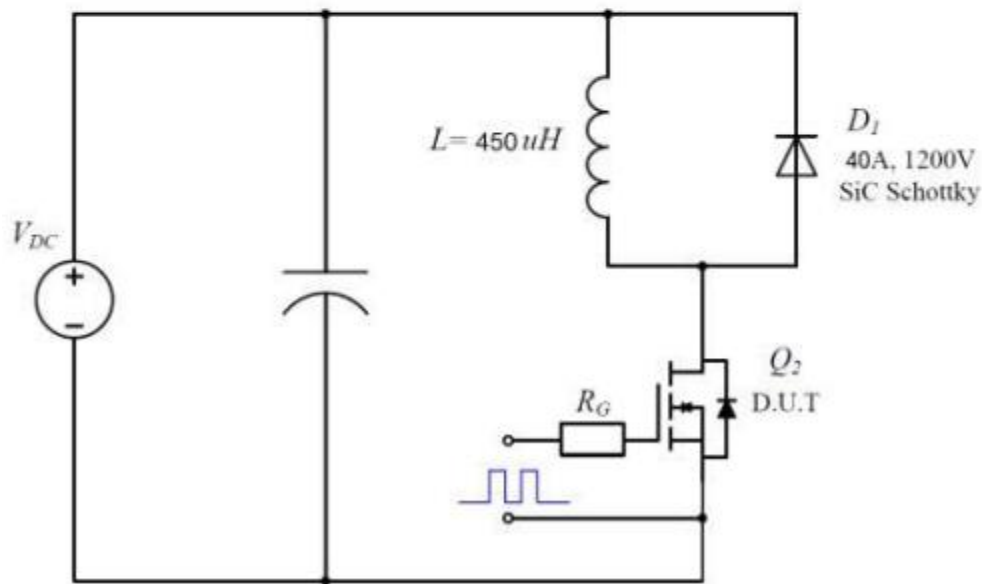
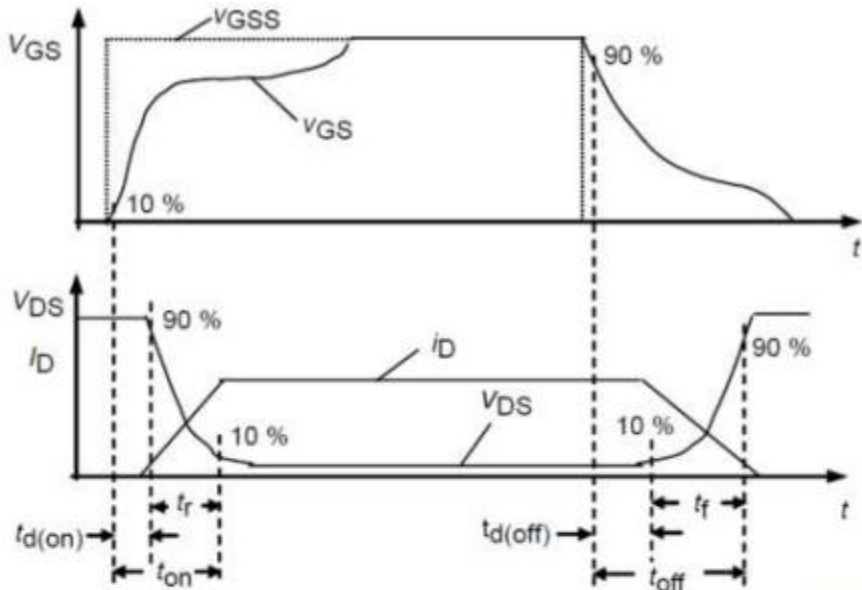

Figure 16. Safe Operating Area

Caution: This device is sensitive to electrostatic discharge .Users should follow ESD handing procedures.

Switching Times Definition and Test Circuit



Caution: This device is sensitive to electrostatic discharge .Users should follow ESD handing procedures.

Package Outline: TO-247-4

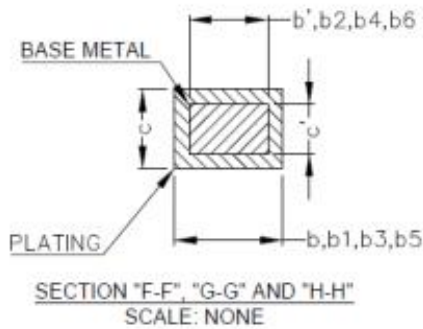
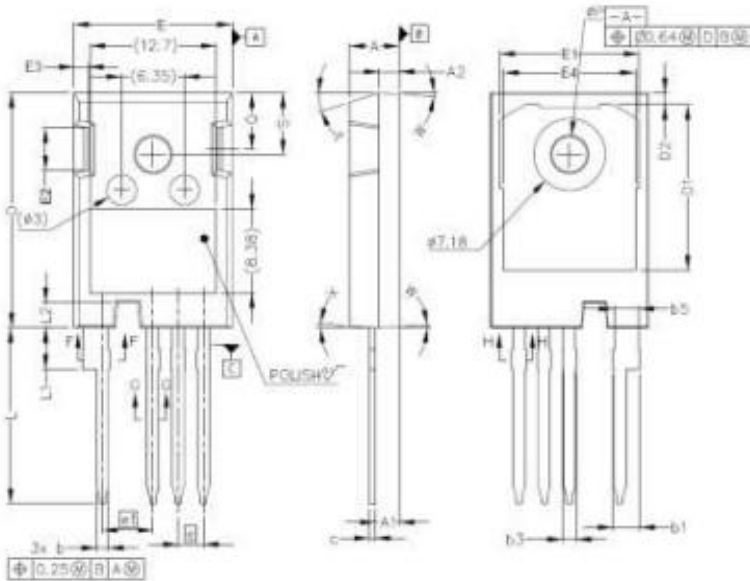

SYMBOL	MILLIMETERS	
	MIN	MAX
A	4.83	5.21
A1	2.29	2.54
A2	1.91	2.16
b'	1.07	1.28
b	1.07	1.33
b1	2.39	2.94
b2	2.39	2.84
b3	1.07	1.60
b4	1.07	1.50
b5	2.39	2.69
b6	2.39	2.64
c'	0.55	0.65
c	0.55	0.68
D	23.30	23.60
D1	16.25	17.65
D2	0.95	1.25
E	15.75	16.13
E1	13.10	14.15
E2	3.68	5.10
E3	1.00	1.90
E4	12.38	13.43
e	2.54 BSC	
e1	5.08 BSC	
N	4	
L	17.31	17.82
L1	3.97	4.37
L2	2.35	2.65
øP	3.51	3.65
Q	5.49	6.00
S	6.04	6.30
T	17.5° REF.	
W	3.5° REF.	
X	4° REF.	

Caution: This device is sensitive to electrostatic discharge .Users should follow ESD handling procedures.