

Features

- Ultra-Low capacitance:0.05pF(typ.)
- Low leakage current(<10nA)
- Fast response time(<1ns)
- Bi-directional,single line protection
- IEC 61000-4-2 (ESD Air): 15kV
IEC 61000-4-2 (ESD Contact): 8kV

Ordering Information

Part Number	Qty per Reel	Reel Size
TPESD0201G Series	15000	7"

Mechanical Characteristics

- USB 3.0/3.1
- HDMI 1.3/1.4/2.0
- RF Antenna
- SATA and eSATA Interface

Applications

- Smart Phone/Mobile Internet Device
- Laptop/Desktop Computer
- Bi-directional, single line protection
- Antennas (Cell Phones, GPS...)
- High Speed Ethernet
- USB 3.0 and USB 3.1

Dimensions and Pin Configuration

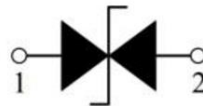
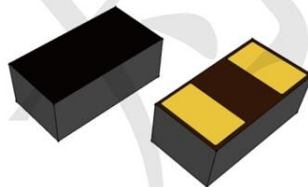

Absolute Maximum Ratings (Tamb=25°C unless otherwise specified)

Parameter	Symbol	Value	Unit
ESD per IEC 61000-4-2 (Air)	VESD	±15	kV
ESD per IEC 61000-4-2 (Contact)		±8	
Operating Temperature Range	TJ	-55 to +125	°C
Storage Temperature Range	Tstg	-40 to +85	°C

Electrical Characteristics (TA=25°C unless otherwise specified)

TPESD0201G03V

Parameter	Symbol	Min	Typ	Max	Unit	Test Condition
Continuous Operating Voltage	V _{DC}			3.3	V	
Trigger Voltage	V _T		450		V	IEC61000-4-2 8kV contact discharge
Clamping Voltage	V _C		40		V	IEC61000-4-2 8kV contact discharge
Leakage Current	I _L			10	nA	DC 3.3V shall be applied on component
Capacitance	C _J		0.05		pF	Measured at 10MHz

TPESD0201G05V

Parameter	Symbol	Min	Typ	Max	Unit	Test Condition
Continuous Operating Voltage	V _{DC}			5	V	
Trigger Voltage	V _T		450		V	IEC61000-4-2 8kV contact discharge
Clamping Voltage	V _C		40		V	IEC61000-4-2 8kV contact discharge
Leakage Current	I _L			10	nA	DC 5V shall be applied on component
Capacitance	C _J		0.05		pF	Measured at 10MHz

TPESD0201G08V

Parameter	Symbol	Min	Typ	Max	Unit	Test Condition
Continuous Operating Voltage	V_{DC}			8	V	
Trigger Voltage	V_T		450		V	IEC61000-4-2 8kV contact discharge
Clamping Voltage	V_C		40		V	IEC61000-4-2 8kV contact discharge
Leakage Current	I_L			10	nA	DC 8V shall be applied on component
Capacitance	C_J		0.05		pF	Measured at 10MHz

TPESD0201G12V

Parameter	Symbol	Min	Typ	Max	Unit	Test Condition
Continuous Operating Voltage	V_{DC}			12	V	
Trigger Voltage	V_T		450		V	IEC61000-4-2 8kV contact discharge
Clamping Voltage	V_C		40		V	IEC61000-4-2 8kV contact discharge
Leakage Current	I_L			10	nA	DC 12V shall be applied on component
Capacitance	C_J		0.05		pF	Measured at 10MHz

TPESD0201G15V

Parameter	Symbol	Min	Typ	Max	Unit	Test Condition
Continuous Operating Voltage	V_{DC}			15	V	
Trigger Voltage	V_T		450		V	IEC61000-4-2 8kV contact discharge
Clamping Voltage	V_C		40		V	IEC61000-4-2 8kV contact discharge
Leakage Current	I_L			10	nA	DC 15 V shall be applied on component
Capacitance	C_J		0.05		pF	Measured at 10MHz

TPESD0201G24V

Parameter	Symbol	Min	Typ	Max	Unit	Test Condition
Continuous Operating Voltage	V_{DC}			24	V	
Trigger Voltage	V_T		450		V	IEC61000-4-2 8kV contact discharge
Clamping Voltage	V_C		40		V	IEC61000-4-2 8kV contact discharge
Leakage Current	I_L			10	nA	DC 24V shall be applied on component
Capacitance	C_J		0.05		pF	Measured at 10MHz

TPESD0201G36V

Parameter	Symbol	Min	Typ	Max	Unit	Test Condition
Continuous Operating Voltage	V_{DC}			36	V	
Trigger Voltage	V_T		450		V	IEC61000-4-2 8kV contact discharge
Clamping Voltage	V_C		40		V	IEC61000-4-2 8kV contact discharge
Leakage Current	I_L			10	nA	DC 36V shall be applied on component
Capacitance	C_J		0.05		pF	Measured at 10MHz

PROTECTION PRODUCTS
Typical characteristics

HDMI Mask at 3.4 Gbps

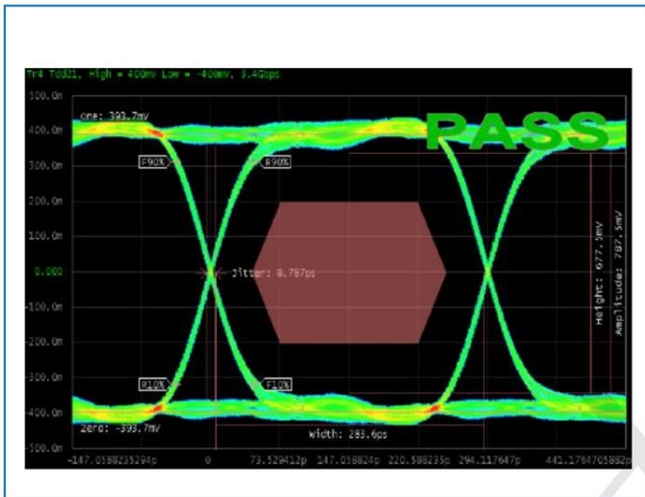

USB3.0 Mask at 5.0 Gbps

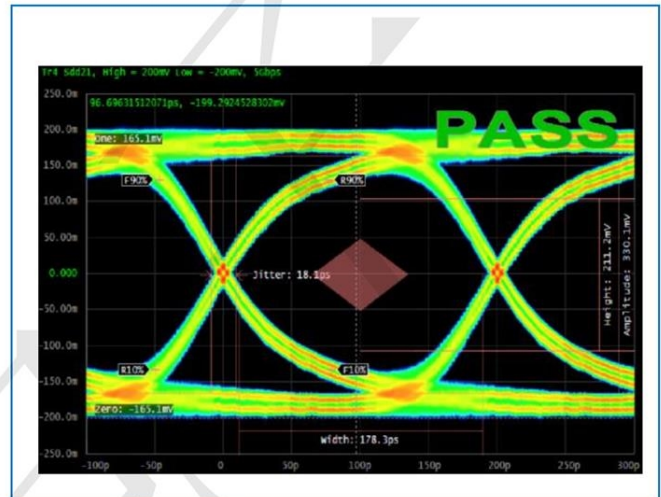

ESD Protection for Signal Line

The TPESD0201G is designed for the protection of one bidirectional data line from ESD damage.

- Place the TPESD0201G as close to the input terminal or connector as possible.
- Minimize the path length between the TPESD0201G and the protected signal line.
- Use ground planes whenever possible.

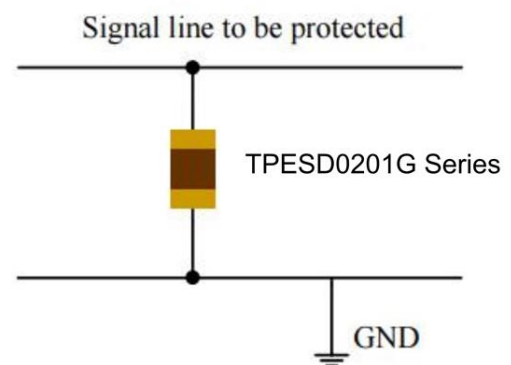
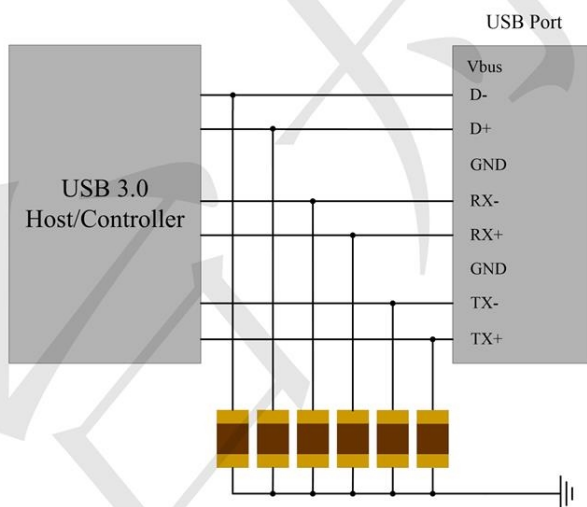

Package Dimension

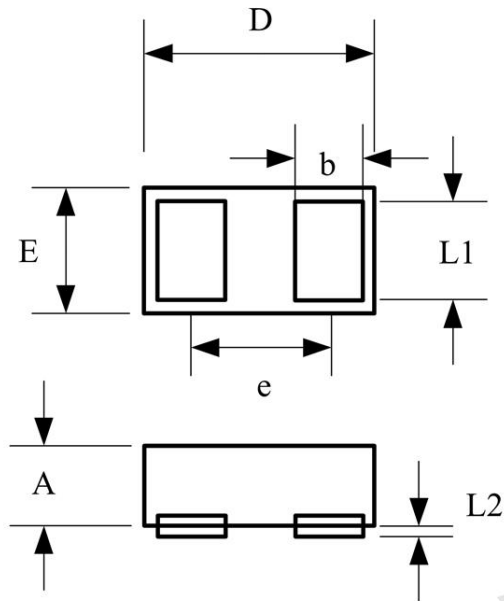

Recommended Solder Pad Footprint

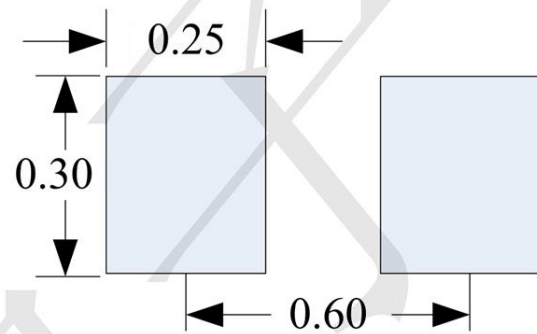

***Sizes in mm**

Notes:

This solder pad layout is for reference purposes only.

Dimension	Unit: Millimeters	
	Min.	Max.
A	0.25	0.40
b	0.15	0.20
D	0.50	0.70
E	0.25	0.35
e	0.45BSC	
L1	0.20	0.30
L2	0.00	0.05