

General Features

- $V_{DS}=30V$ $I_D=6A$
- $R_{DS(ON)} < 23m\Omega$, $V_{GS}@10V$,
- $R_{DS(ON)} < 32m\Omega$, $V_{GS}@4.5V$,

Application

- Load/Power Switching
- Interfacing Switching
- Battery Management for Ultra Small Portable Electronics
- Logic Level Shift

Package and Pin Configuration

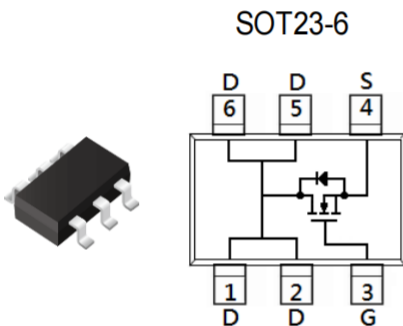

Block Diagram



Absolute Maximum Ratings ($T_A=25^\circ C$ unless otherwise noted)

PARAMETER	SYMBOL	LIMIT	UNITS
Drain-Source Voltage	V_{DS}	30	V
Gate-Source Voltage	V_{GS}	+20	
Continuous Drain Current (Note 4)	I_D	6	A
Pulsed Drain Current (Note 1)	I_{DM}	25	
Power Dissipation	$T_a=25^\circ C$	2	W
	Derate above $25^\circ C$	16	mW/ $^\circ C$
Operating Junction and Storage Temperature Range	T_J, T_{STG}	-55~150	$^\circ C$
Typical Thermal Resistance	$R_{\theta JA}$	62.5	$^\circ C/W$
- Junction to Ambient (Note 3)			

Parameter	Conditions	Symbol	Min	Typ	Max	Unit
Static						
Drain-Source Breakdown Voltage	$V_{GS} = 0V, I_D = 250\mu A$	BV_{DSS}	30	--	--	V
Drain-Source On-State Resistance	$V_{GS} = 10V, I_D = 6A$	$R_{DS(on)}$	--	18	23	mΩ
	$V_{GS} = 4.5V, I_D = 4A$		--	22	32	
Gate Threshold Voltage	$V_{DS} = V_{GS}, I_D = 250\mu A$	$V_{GS(TH)}$	1.0	1.5	2.5	V
Zero Gate Voltage Drain Current	$V_{DS} = 30V, V_{GS} = 0V$	I_{DSS}	--	--	1	μA
	$V_{DS} = 24V, T_J = 125^\circ C$		--	--	10	
Gate Body Leakage	$V_{GS} = \pm 20V, V_{DS} = 0V$	I_{GSS}	--	--	±100	μA
Forward Transconductance ^(Note 3)	$V_{DS} = 10V, I_D = 4A$	g_{fs}	--	6.5	--	S
Dynamic						
Total Gate Charge ^(Note 3,4)	$V_{DS} = 15V, I_D = 6A,$ $V_{GS} = 4.5V$	Q_g	--	4.1	--	nC
Gate-Source Charge ^(Note 3,4)		Q_{gs}	--	1	--	
Gate-Drain Charge ^(Note 3,4)		Q_{gd}	--	2.1	--	
Input Capacitance	$V_{DS} = 25V, V_{GS} = 0V,$ $f = 1.0MHz$	C_{iss}	--	345	--	pF
Output Capacitance		C_{oss}	--	55	--	
Reverse Transfer Capacitance		C_{rss}	--	32	--	
Switching						
Turn-On Delay Time ^(Note 3,4)	$V_{DD} = 15V, I_D = 1A,$ $V_{GS} = 10V, R_G = 6\Omega$	$t_{d(on)}$	--	2.8	--	ns
Turn-On Rise Time ^(Note 3,4)		t_r	--	7.2	--	
Turn-Off Delay Time ^(Note 3,4)		$t_{d(off)}$	--	15.8	--	
Turn-Off Fall Time ^(Note 3,4)		t_f	--	4.6	--	
Source-Drain Diode Ratings and Characteristic						
Maximum Continuous Drain-Source Diode Forward Current	Integral reverse diode in the MOSFET	I_S	--	--	6	A
Maximum Pulse Drain-Source Diode Forward Current		I_{SM}	--	--	25	A
Diode-Source Forward Voltage	$V_{GS} = 0V, I_S = 1A$	V_{SD}	--	--	1	V

Note:

1. Pulse width limited by safe operating area
2. $L = 1mH, I_{AS} = 8A, V_{DD} = 25V, R_G = 25\Omega, \text{Starting } T_J = 25^\circ C$
3. Pulse test: pulse width $\leq 300\mu s$, duty cycle $\leq 2\%$
4. Switching time is essentially independent of operating temperature.

Typical Electrical and Thermal Characteristics (Curves)

Continuous Drain Current vs. T_c

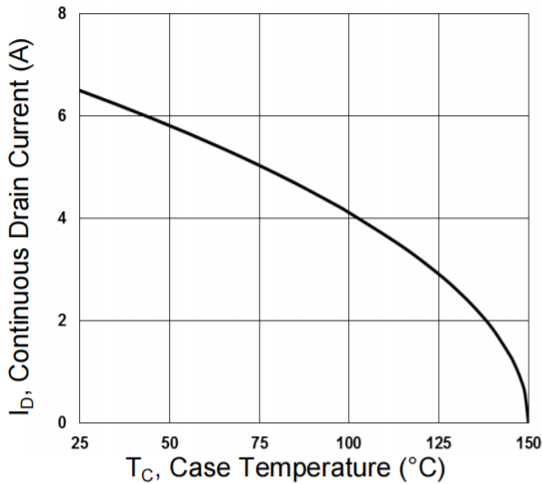

Gate Charge

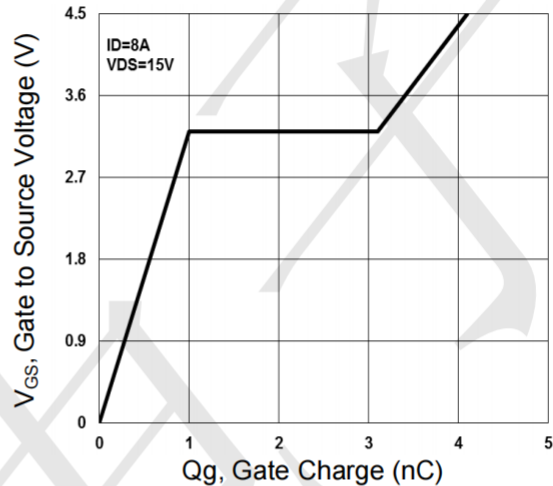

On-Resistance vs. Junction Temperature

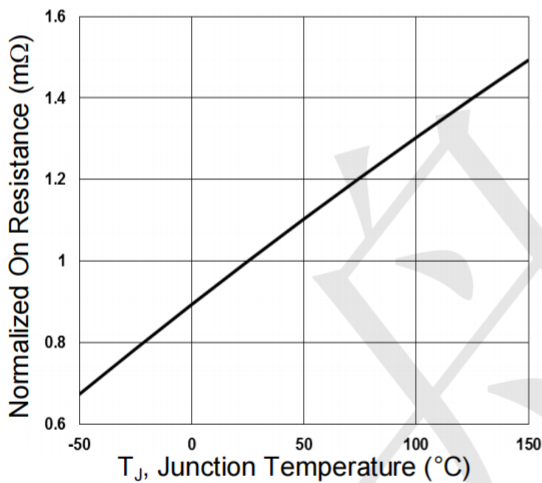

Threshold Voltage vs. Junction Temperature

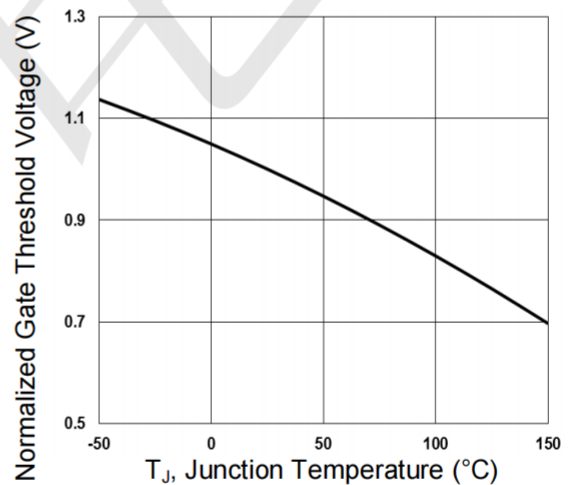

Maximum Safe Operating Area

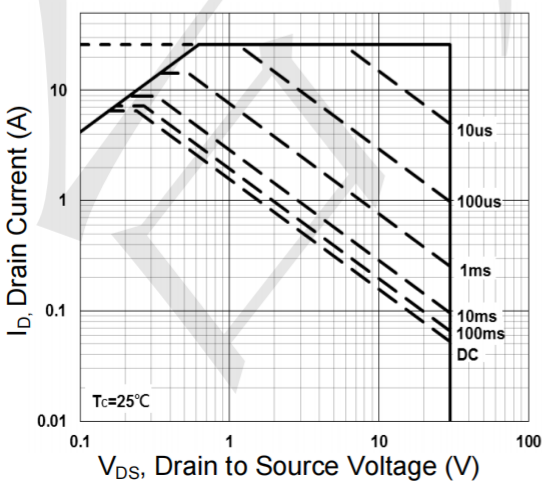

Normalized Thermal Transient Impedance Curve

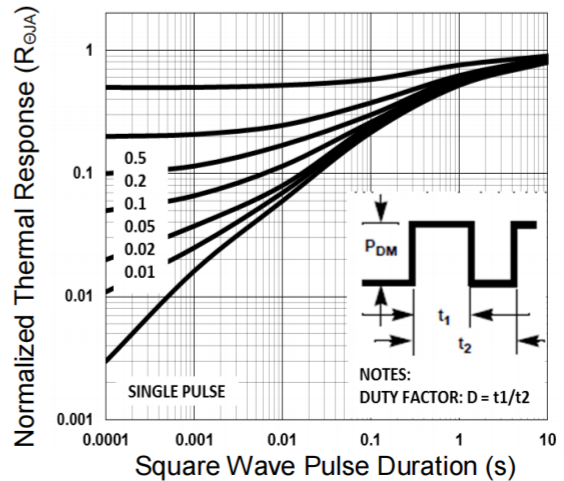

SOT23-6 Package Information

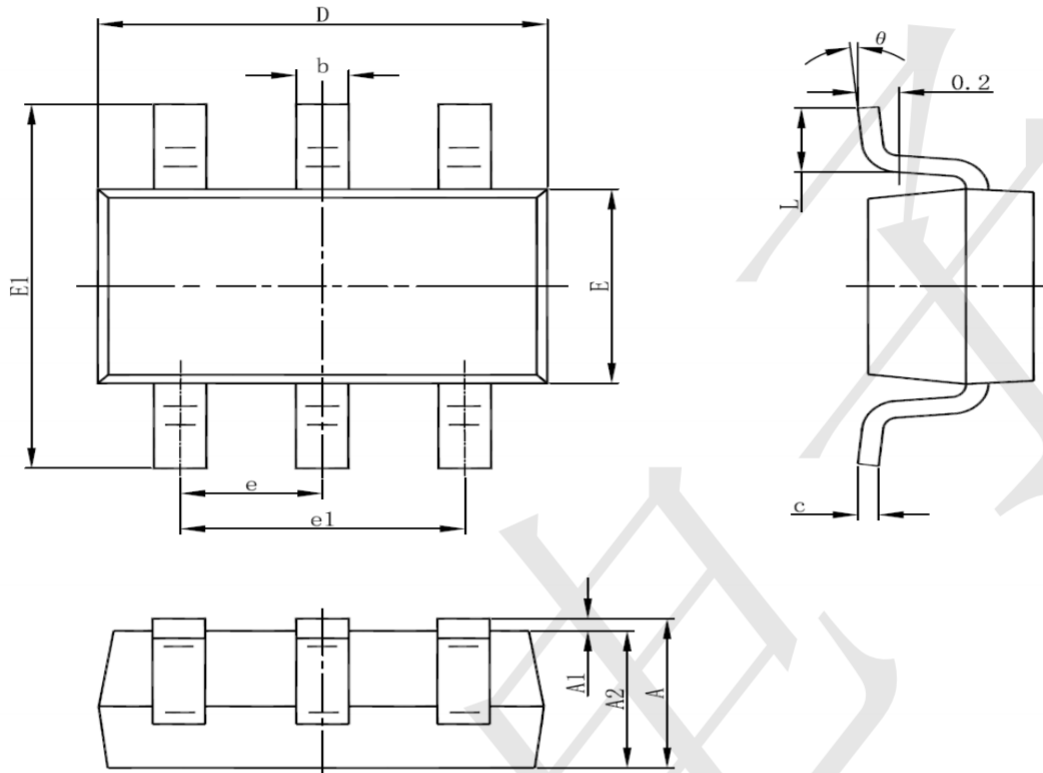

Symbol	Dimensions In Millimeters		Dimensions In Inches	
	Min	Max	Min	Max
A	1.050	1.250	0.041	0.049
A1	0.000	0.100	0.000	0.004
A2	1.050	1.150	0.041	0.045
b	0.300	0.500	0.012	0.020
c	0.100	0.200	0.004	0.008
D	2.820	3.020	0.111	0.119
E	1.500	1.700	0.059	0.067
E1	2.650	2.950	0.104	0.116
e	0.950(BSC)		0.037(BSC)	
e1	1.800	2.000	0.071	0.079
L	0.300	0.600	0.012	0.024
θ	0°	8°	0°	8°