

Product Summary

- $V_{DS} = 20V$, $I_D = 5.5A$
 $R_{DS(ON)} < 25m\Omega$ @ $V_{GS} = 4.5V$

Application

- Load Switch for Portable Devices
- DC/DC Converter

Package and Pin Configuration

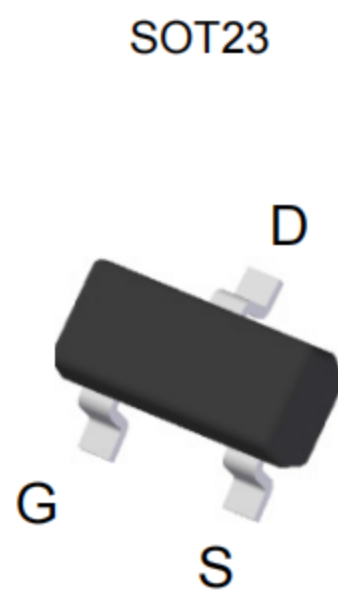

Circuit diagram

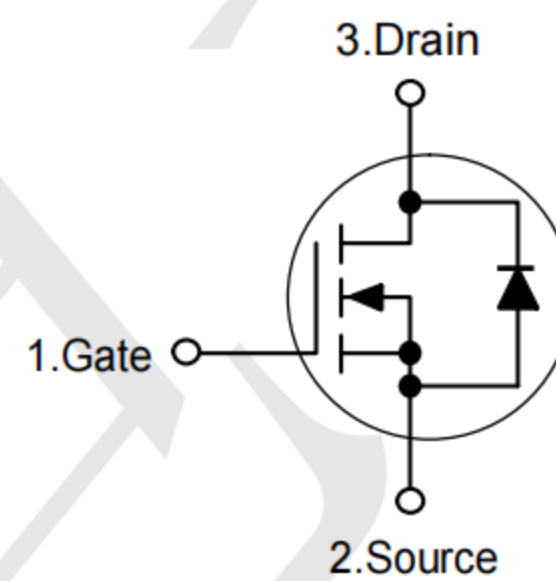

Marking: A0D

Absolute Maximum Ratings

Ratings at 25°C ambient temperature unless otherwise specified.

Parameter	Symbol	Value	Unit
Drain-Source Voltage	V_{DS}	20	V
Gate-Source Voltage	V_{GS}	±8	V
Drain Current-Continuous	I_D	5.5	A
Drain Current-Pulsed ^{Note1}	I_{DM}	18	A
Maximum Power Dissipation	P_D	1	W
Junction Temperature	T_J	150	°C
Storage Temperature Range	T_{STG}	-55 to +150	°C

Thermal Characteristics

Thermal Resistance, Junction-to-Ambient ^{Note2}	1	$R_{\theta JA}$	125	°C/W
--	---	-----------------	-----	------

ELECTRICAL CHARACTERISTICS ($T_A=25^\circ\text{C}$ unless otherwise noted)

Parameter	Symbol	Test Condition	Min.	Typ.	Max.	Unit
Static Characteristics						
Drain-Source Breakdown Voltage	$V_{(BR)DSS}$	$V_{GS}=0V, I_D=250\mu A$	20	--	--	V
Zero Gate Voltage Drain Current	I_{DSS}	$V_{DS}=20V, V_{GS}=0V$	--	--	1	μA
Gate-Body Leakage Current	I_{GSS}	$V_{GS}=\pm 8V, V_{DS}=0V$	--	--	± 100	nA
Gate Threshold Voltage ^{Note3}	$V_{GS(th)}$	$V_{DS}=V_{GS}, I_D=250\mu A$	0.45	--	1	V
Drain-Source On-Resistance ^{Note3}	$R_{DS(on)}$	$V_{GS}=4.5V, I_D=4A$			25	m Ω
		$V_{GS}=2.5V, I_D=3A$			35	m Ω
Forward Transconductance ^{Note3}	g_{FS}	$V_{DS}=5V, I_D=3A$	--	8	--	S
Dynamic Characteristics						
Input Capacitance	C_{iss}	$V_{DS}=10V, V_{GS}=0V, f=1MHz$	--	300	--	pF
Output Capacitance	C_{oss}		--	120	--	pF
Reverse Transfer Capacitance	C_{rss}		--	80	--	pF
Switching Characteristics						
Turn-on Delay Time	$t_{d(on)}$	$V_{DD}=10V, V_{GS}=4.5V$ $I_D=3A, R_{GEN}=6\Omega$	--	10	--	nS
Turn-on Rise Time	t_r		--	50	--	nS
Turn-off Delay Time	$t_{d(off)}$		--	17	--	nS
Turn-off Fall Time	t_f		--	10	--	nS
Total Gate Charge	Q_g	$V_{DS}=10V, V_{GS}=4.5V$ $I_D=4A$	--	4.0	--	nC
Gate-Source Charge	Q_{gs}		--	0.65	--	nC
Gate-Drain Charge	Q_{gd}		--	1.2	--	nC
Source-Drain Diode Characteristics						
Diode Forward Voltage ^{Note3}	V_{SD}	$V_{GS}=0V, I_S=5.5A$	--	--	1.2	V
Diode Forward Current ^{Note2}	I_S		--	--	5.5	A

TYPICAL ELECTRICAL AND THERMAL CHARACTERISTICS

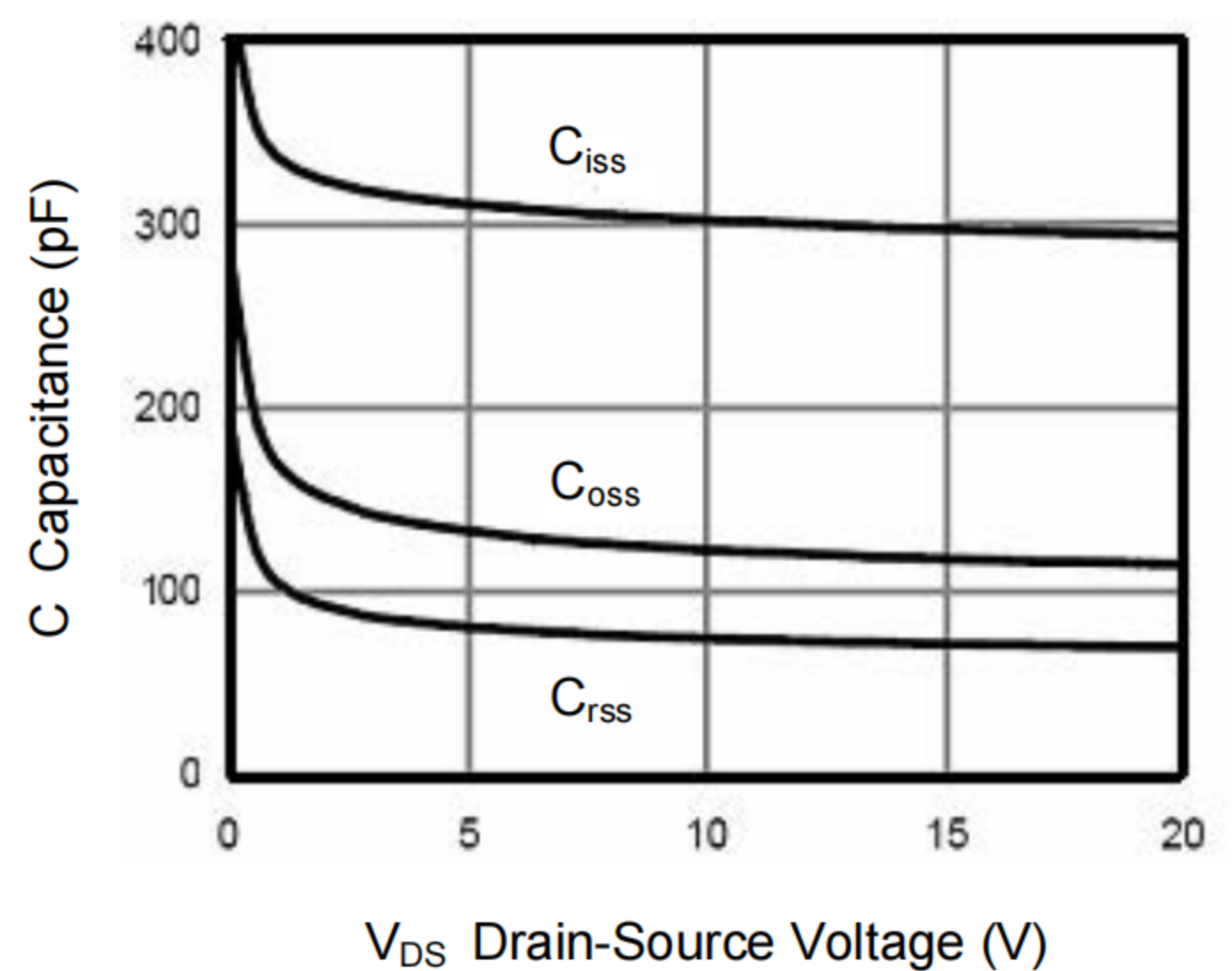
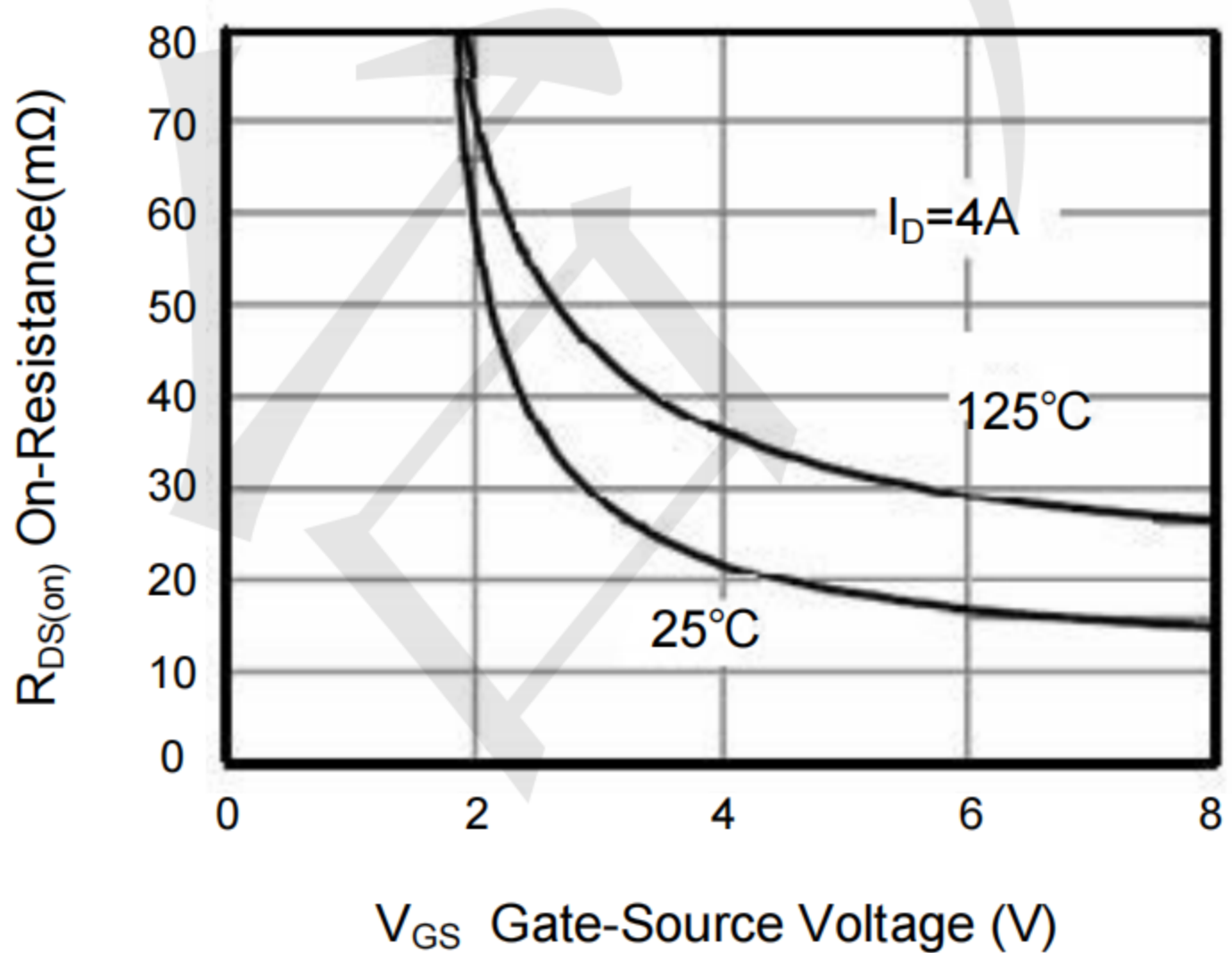
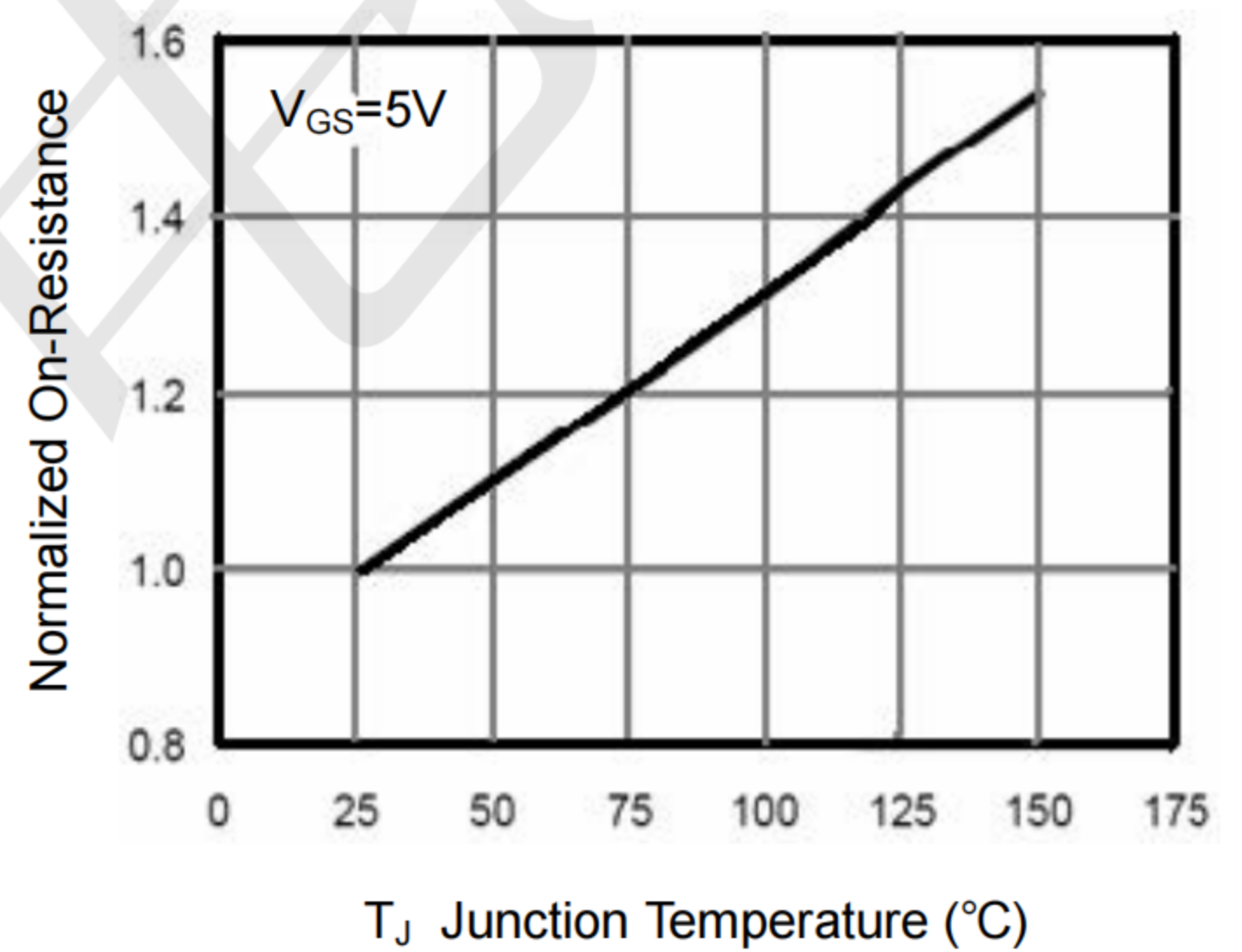
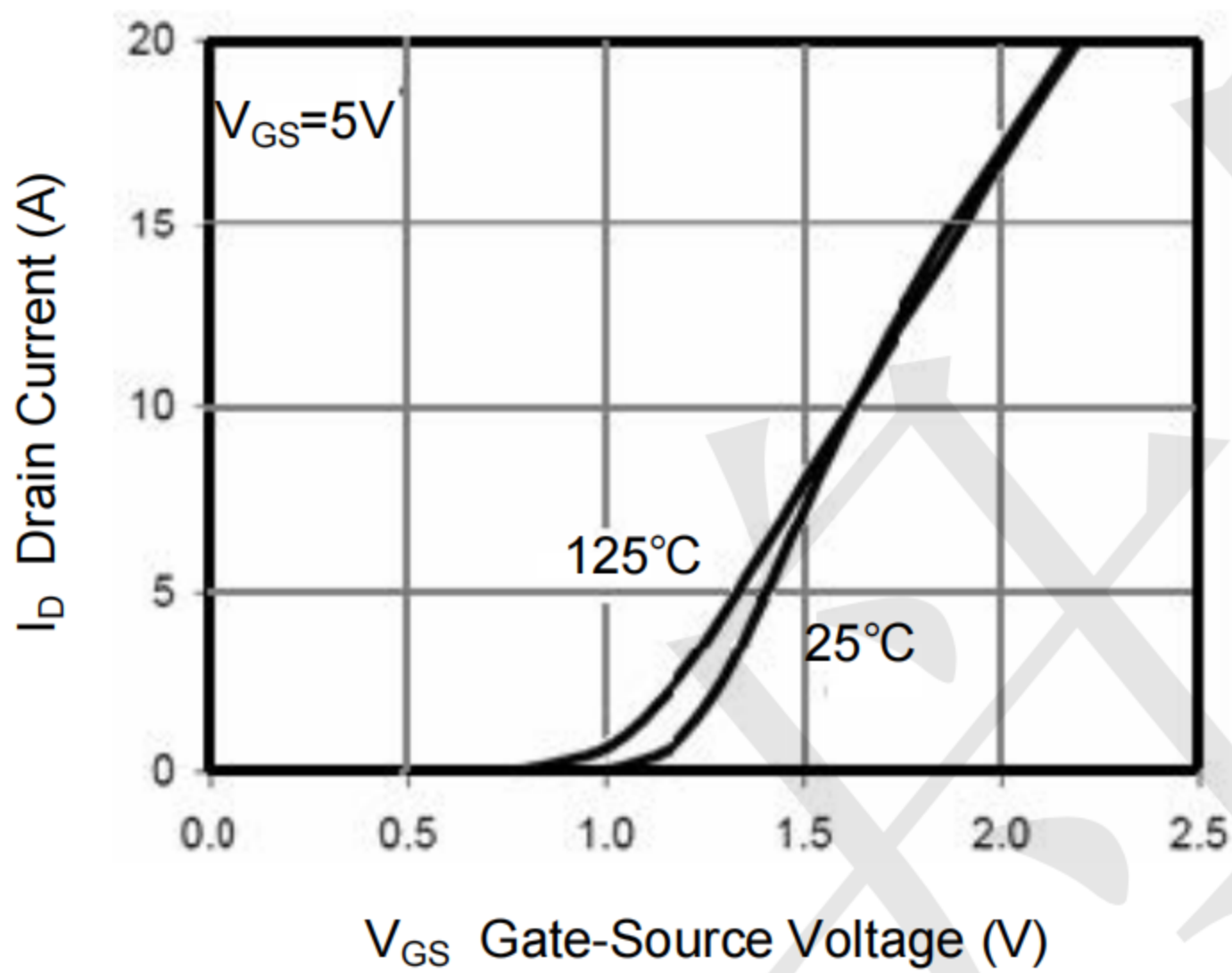
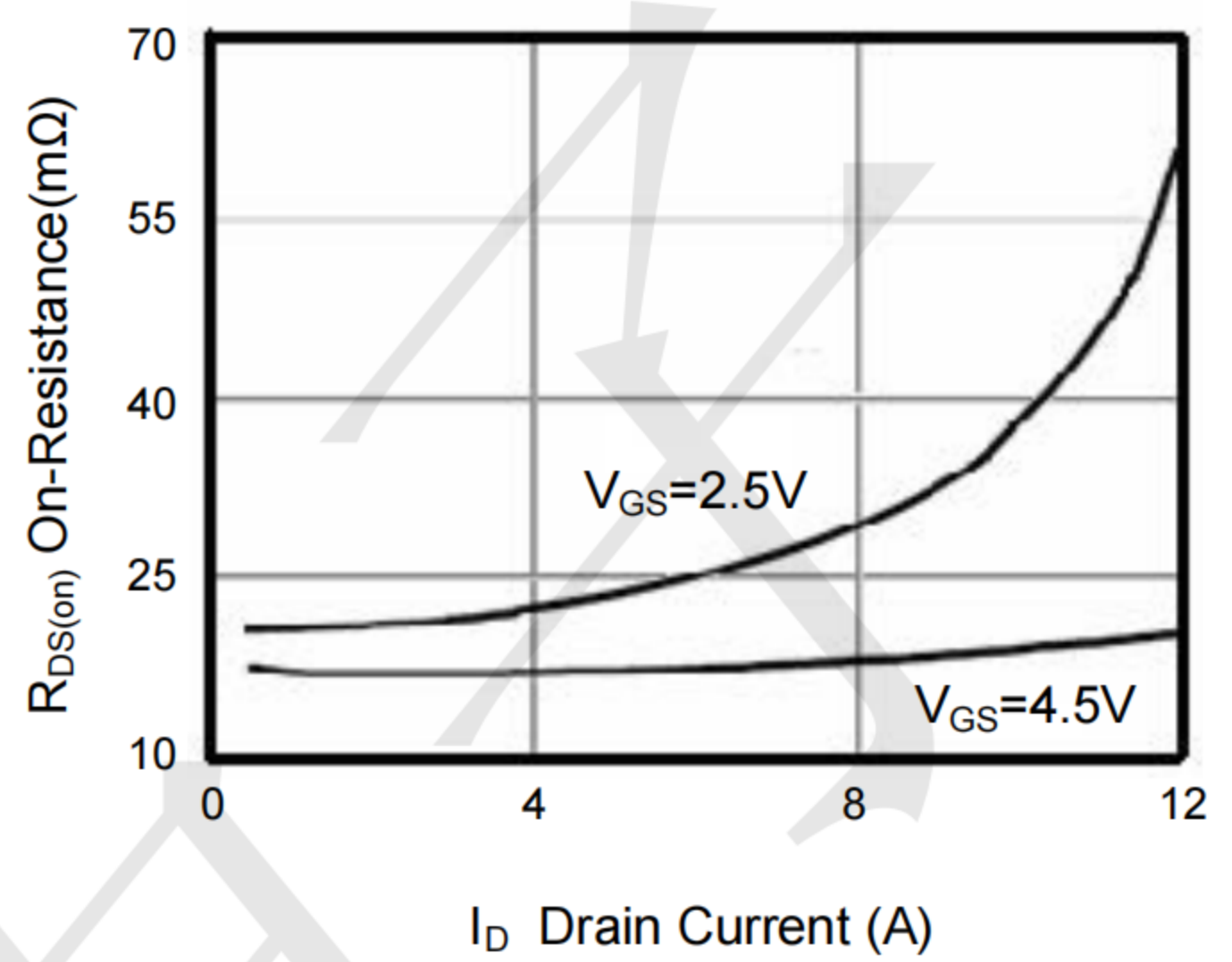
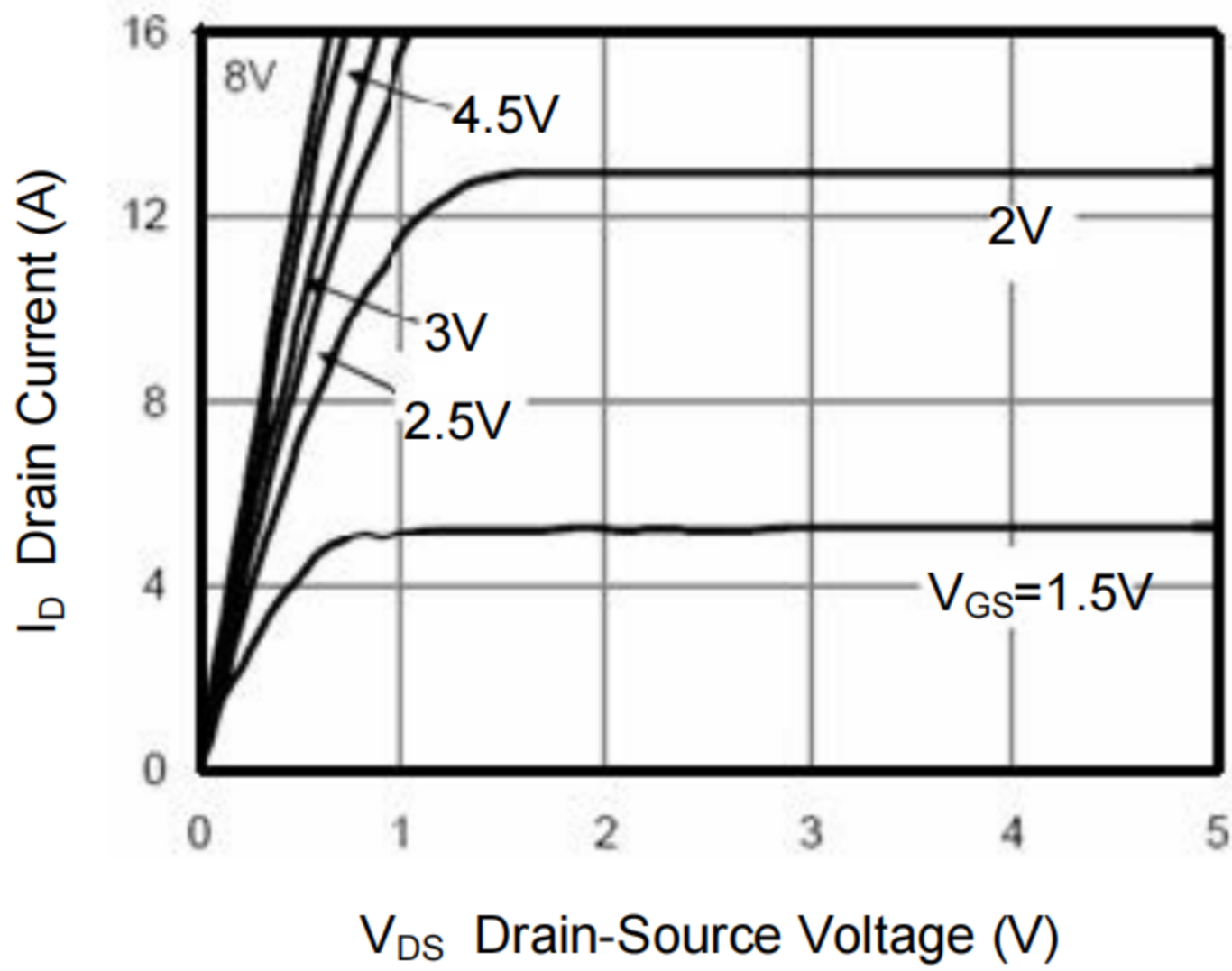

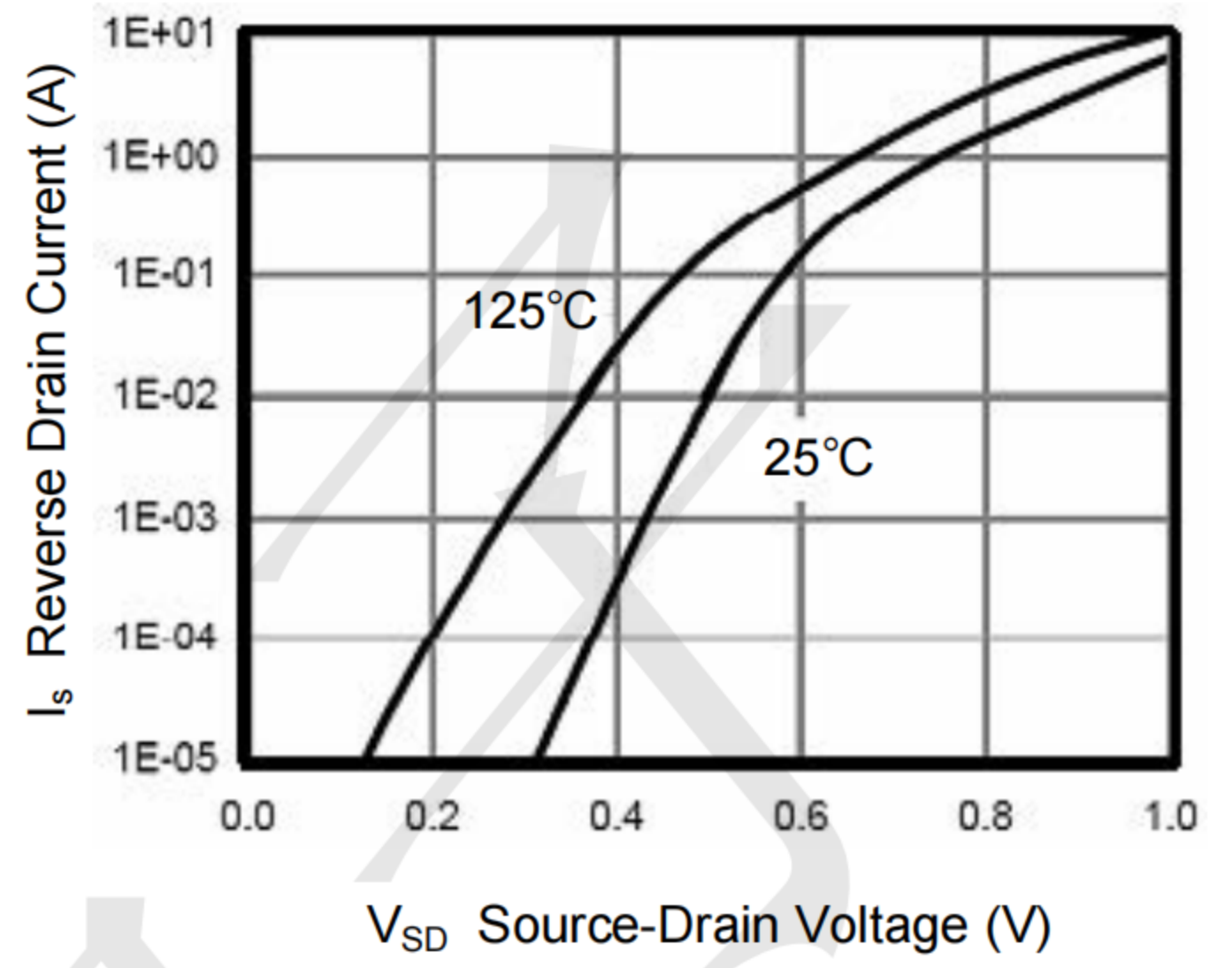
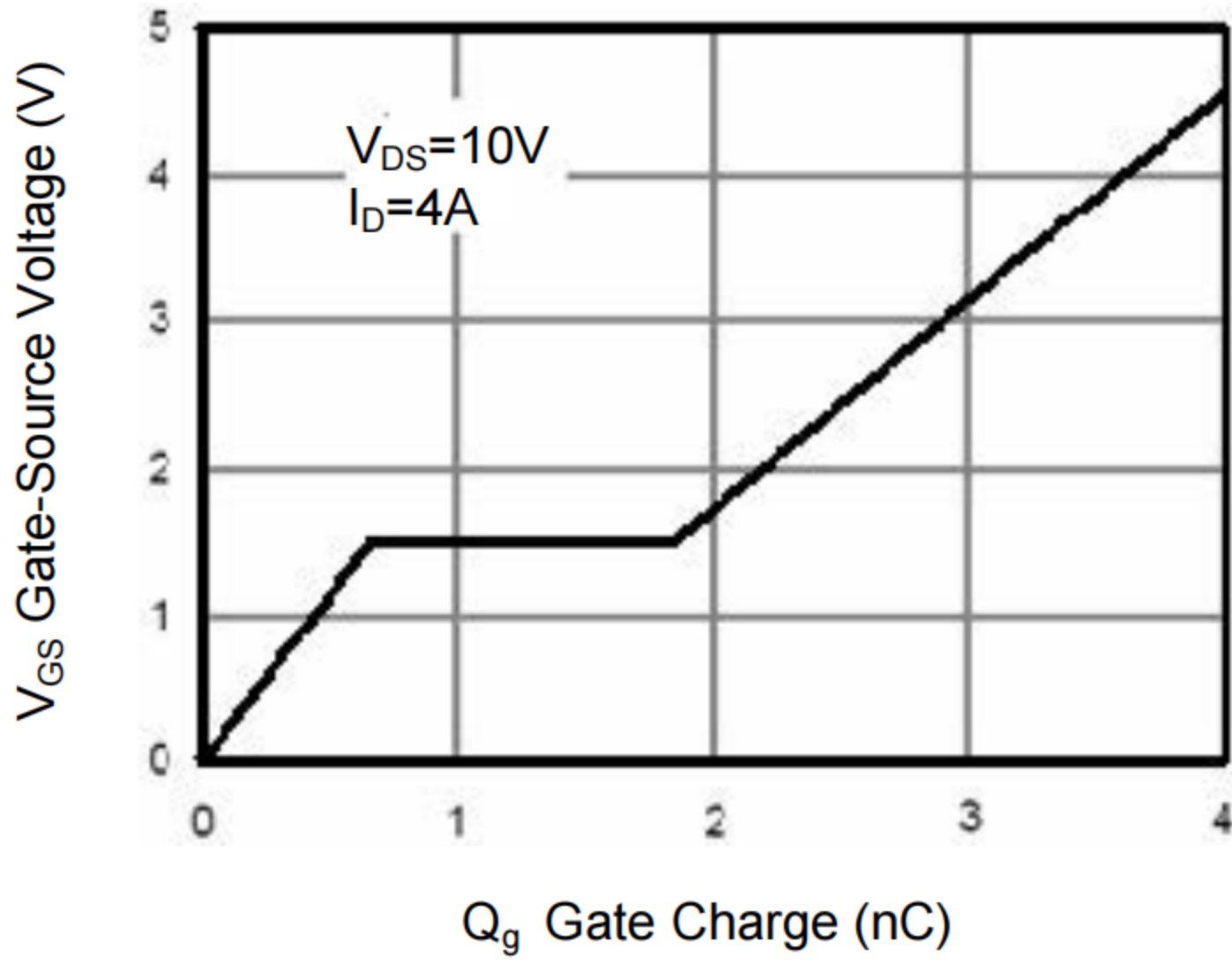

Package Outline Dimensions (SOT-23)

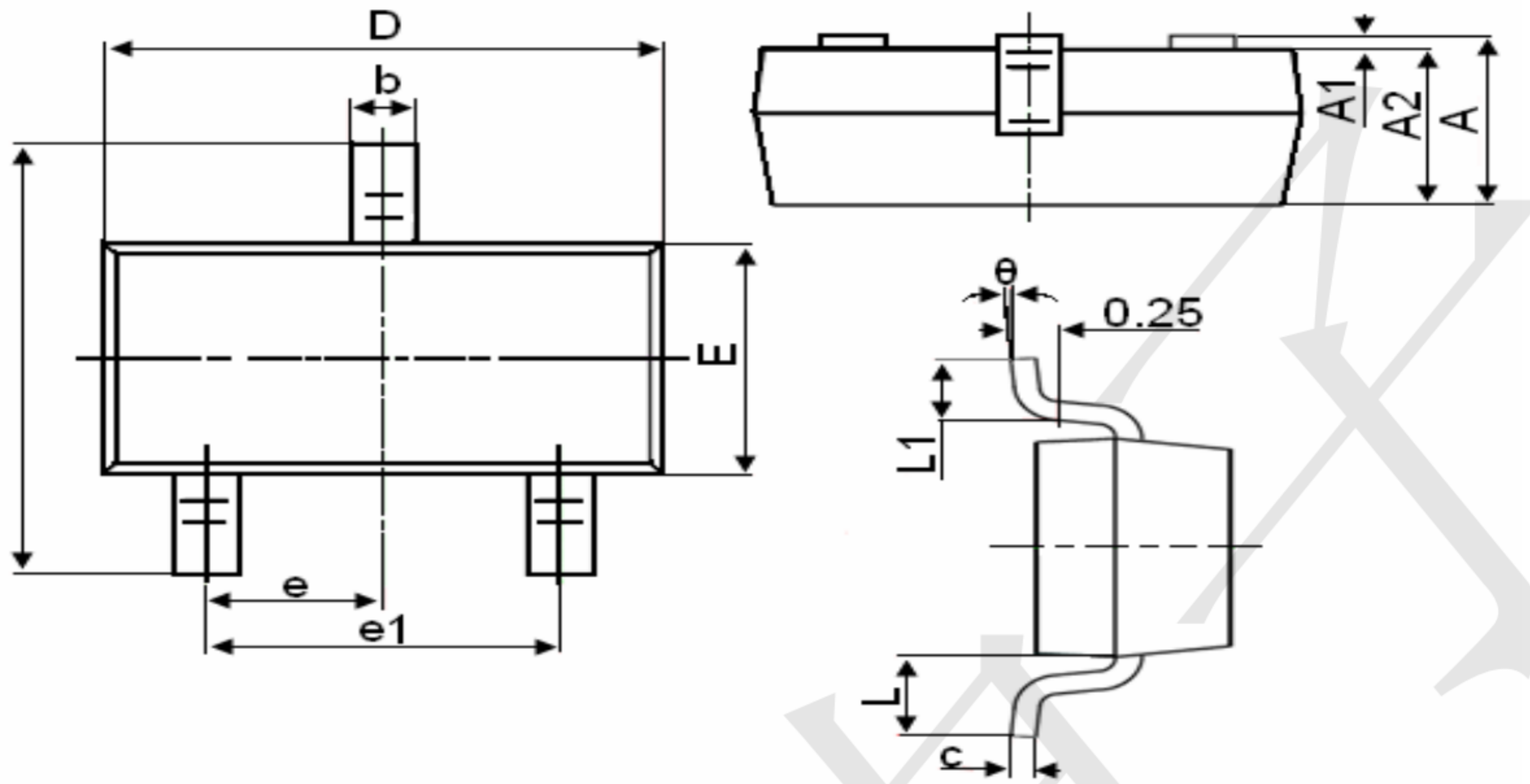

Symbol	Dimensions in Millimeters	
	MIN.	MAX.
A	0.900	1.150
A1	0.000	0.100
A2	0.900	1.050
b	0.300	0.500
c	0.080	0.150
D	2.800	3.000
E	1.200	1.400
E1	2.250	2.550
e	0.950TYP	
e1	1.800	2.000
L	0.550REF	
L1	0.300	0.500
θ	0°	8°