

### GENERAL FEATURES

N-CH	$BV_{DSS}$	30V
	$R_{DS(ON)}$	22m $\Omega$
	$I_D$	7A
P-CH	$BV_{DSS}$	-30V
	$R_{DS(ON)}$	30m $\Omega$
	$I_D$	-6.0A

### Application

- Battery protection
- Load switch

### Package and Pin Configuration

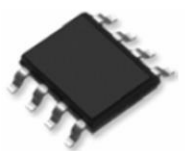

SOP-8 top view

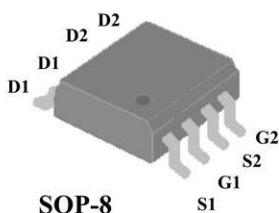

SOP-8

### Circuit diagram

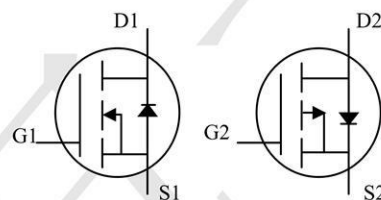

### Marking:

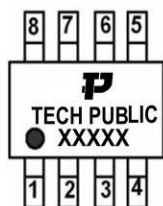

“P” is TECHPUBLIC LOGO

“XXXXX” Marking ID (Please see the last page for details )

### Absolute Maximum Ratings ( $T_A=25^\circ\text{C}$ unless otherwise noted)

PARAMETER	SYMBOL	N-CH LIMIT	P-CH LIMIT	UNITS	
Drain-Source Voltage	$V_{DS}$	30	-30	V	
Gate-Source Voltage	$V_{GS}$	+20			
Continuous Drain Current (Note 4)	$I_D$	$T_A=25^\circ\text{C}$	7	-6	A
		$T_A=70^\circ\text{C}$	5.6	-5	
Pulsed Drain Current (Note 1)	$I_{DM}$	$T_C=25^\circ\text{C}$	28	-24	
Power Dissipation	$P_D$	$T_A=25^\circ\text{C}$	1.7		W
		$T_A=70^\circ\text{C}$	1.1		
Operating Junction and Storage Temperature Range	$T_J, T_{STG}$	-55~150		$^\circ\text{C}$	
Typical Thermal Resistance Junction to Ambient (Note 4,5)	$R_{\theta JA}$	73.5		$^\circ\text{C/W}$	

### N-CH Electrical Characteristics ( $T_A=25^\circ\text{C}$ unless otherwise noted)

PARAMETER	SYMBOL	TEST CONDITION	MIN.	TYP.	MAX.	UNITS
<b>Static</b>						
Drain-Source Breakdown Voltage	$BV_{DSS}$	$V_{GS}=0V, I_D=250\mu A$	30	-	-	V
Gate Threshold Voltage	$V_{GS(th)}$	$V_{DS}=V_{GS}, I_D=250\mu A$	1	1.67	2.5	
Drain-Source On-State Resistance	$R_{DS(on)}$	$V_{GS}=10V, I_D=6A$	-	-	22	m $\Omega$
Drain-Source On-State Resistance	$R_{DS(on)}$	$V_{GS}=4.5V, I_D=3A$	-	-	28	
Zero Gate Voltage Drain Current	$I_{DSS}$	$V_{DS}=30V, V_{GS}=0V$	-	-	1	$\mu A$
Gate-Source Leakage Current	$I_{GSS}$	$V_{GS}=\pm 20V, V_{DS}=0V$	-	-	$\pm 100$	nA
<b>Dynamic</b> (Note 6)						
Total Gate Charge	$Q_g$	$V_{DS}=15V, I_D=8A,$ $V_{GS}=4.5V$ (Note 2,3)	-	4.8	-	nC
Gate-Source Charge	$Q_{gs}$		-	1.5	-	
Gate-Drain Charge	$Q_{gd}$		-	2	-	
Input Capacitance	$C_{iss}$	$V_{DS}=25V, V_{GS}=0V,$ $f=1\text{MHz}$	-	429	-	pF
Output Capacitance	$C_{oss}$		-	59	-	
Reverse Transfer Capacitance	$C_{rss}$		-	47	-	
Turn-On Delay Time	$t_{d(on)}$	$V_{DS}=15V, I_D=1A,$ $V_{GS}=10V, R_G=6\Omega$ (Note 2,3)	-	6.8	-	ns
Turn-On Rise Time	$t_r$		-	16	-	
Turn-Off Delay Time	$t_{d(off)}$		-	27	-	
Turn-Off Fall Time	$t_f$		-	7.1	-	
<b>Drain-Source Diode</b>						
Maximum Continuous Drain-Source Diode Forward Current	$I_S$	---	-	-	7	A
Diode Forward Voltage	$V_{SD}$	$I_S=1A, V_{GS}=0V$	-	0.74	1	V

PARAMETER	SYMBOL	TEST CONDITION	MIN.	TYP.	MAX.	UNITS
<b>Static</b>						
Drain-Source Breakdown Voltage	$BV_{DSS}$	$V_{GS}=0V, I_D=-250\mu A$	-30	-	-	V
Gate Threshold Voltage	$V_{GS(th)}$	$V_{DS}=V_{GS}, I_D=-250\mu A$	-1	-1.53	-2.5	
Drain-Source On-State Resistance	$R_{DS(on)}$	$V_{GS}=-10V, I_D=-4A$	-	-	30	mΩ
Drain-Source On-State Resistance	$R_{DS(on)}$	$V_{GS}=-4.5V, I_D=-2A$	-	-	45	
Zero Gate Voltage Drain Current	$I_{DSS}$	$V_{DS}=-30V, V_{GS}=0V$	-	-	-1	μA
Gate-Source Leakage Current	$I_{GSS}$	$V_{GS}=+20V, V_{DS}=0V$	-	-	±100	nA
<b>Dynamic</b> <small>(Note 6)</small>						
Total Gate Charge	$Q_g$	$V_{DS}=-15V, I_D=-4A,$ $V_{GS}=-4.5V$ <small>(Note 1,2)</small>	-	7.8	-	nC
Gate-Source Charge	$Q_{gs}$		-	2.7	-	
Gate-Drain Charge	$Q_{gd}$		-	2.8	-	
Input Capacitance	$C_{iss}$	$V_{DS}=-15V, V_{GS}=0V,$ $f=1MHz$	-	846	-	pF
Output Capacitance	$C_{oss}$		-	120	-	
Reverse Transfer Capacitance	$C_{rss}$		-	76	-	
Turn-On Delay Time	$t_{d(on)}$	$V_{DS}=-15V, I_D=-1A,$ $V_{GS}=-10V, R_G=6\Omega$ <small>(Note 1,2)</small>	-	3.6	-	ns
Turn-On Rise Time	$t_r$		-	23	-	
Turn-Off Delay Time	$t_{d(off)}$		-	90	-	
Turn-Off Fall Time	$t_f$		-	50	-	
<b>Drain-Source Diode</b>						
Maximum Continuous Drain-Source Diode Forward Current	$I_S$	---	-	-	-6	A
Diode Forward Voltage	$V_{SD}$	$I_S=-1A, V_{GS}=0V$	-	-0.75	-1	V

**Typical Electrical and Thermal Characteristics (Curves)**

**N-Channel Typical Operating Characteristics**

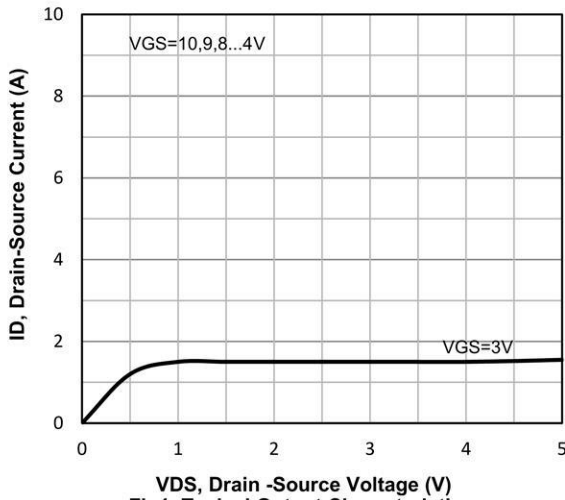

Fig1. Typical Output Characteristics

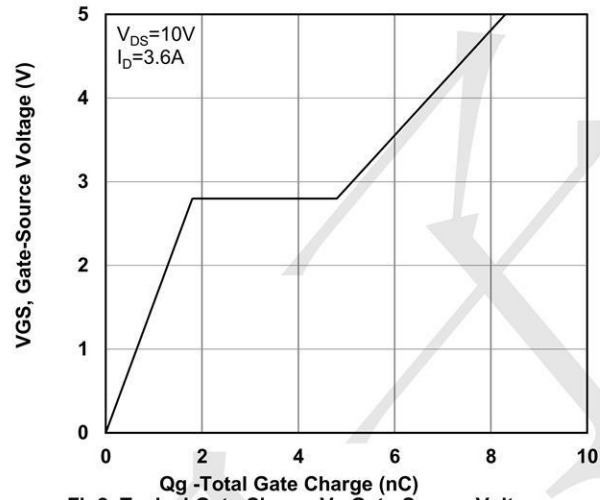

Fig2. Typical Gate Charge Vs. Gate-Source Voltage

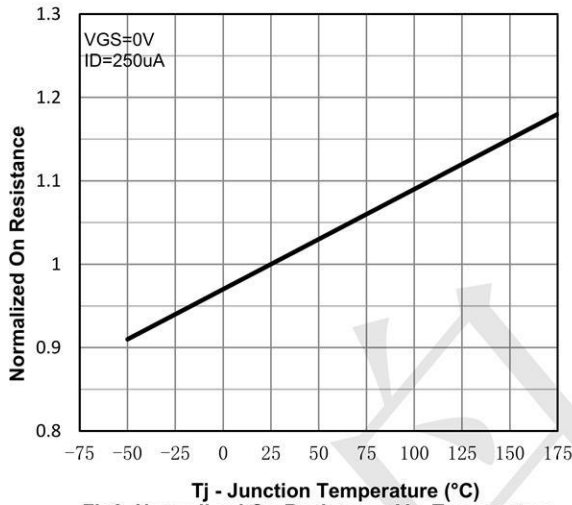

Fig3. Normalized On-Resistance Vs. Temperature

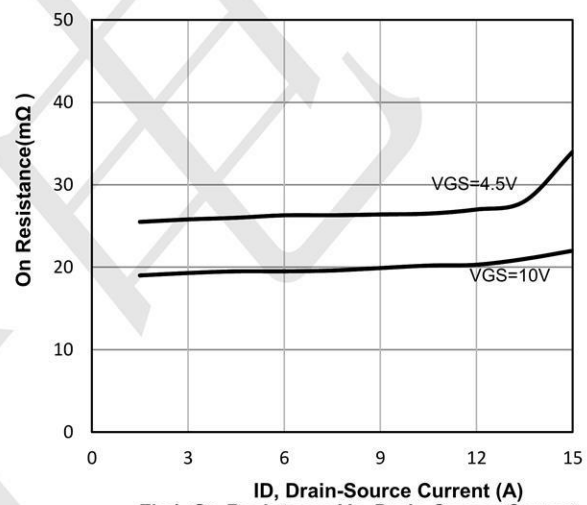

Fig4. On-Resistance Vs. Drain-Source Current

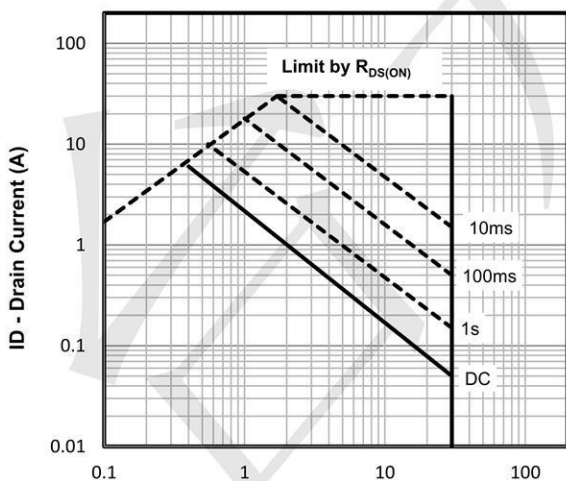

Fig7. Maximum Safe Operating Area

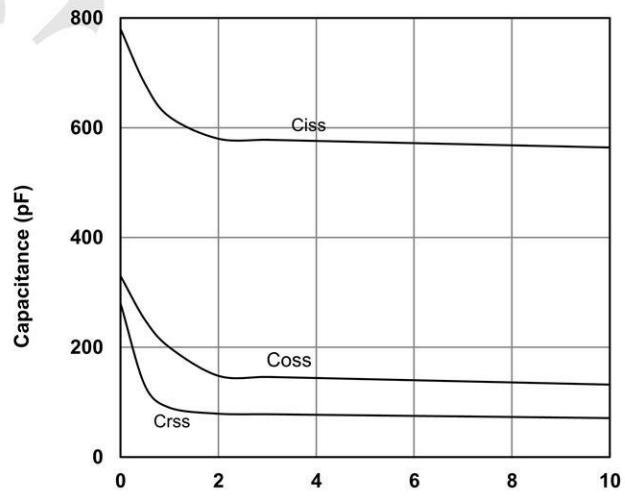
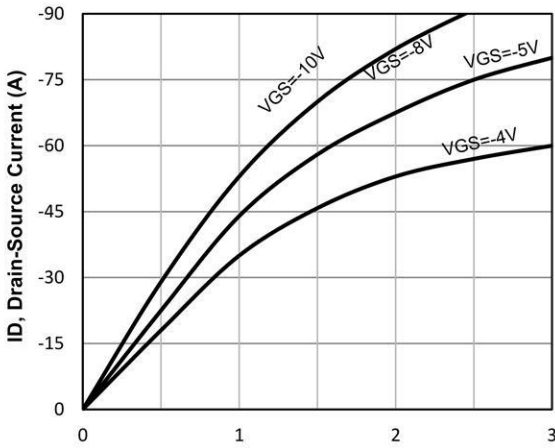

Fig6. Typical Capacitance Vs. Drain-Source Voltage



**P-Channel Typical Operating Characteristics**



VDS, Drain -Source Voltage (V)  
Fig1. Typical Output Characteristics

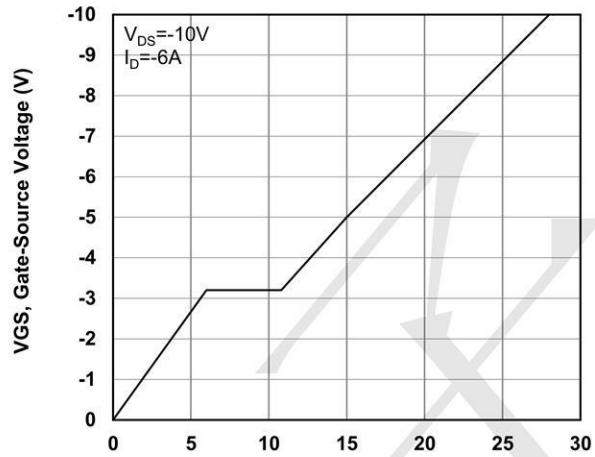

Qg -Total Gate Charge (nC)  
Fig2. Typical Gate Charge Vs. Gate-Source Voltage

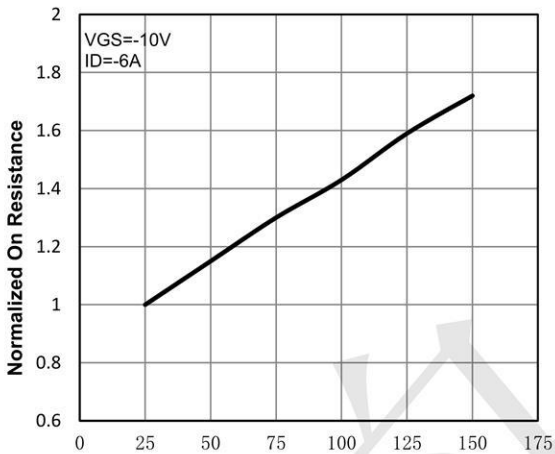

Tj - Junction Temperature (°C)  
Fig3. Normalized On-Resistance Vs. Temperature

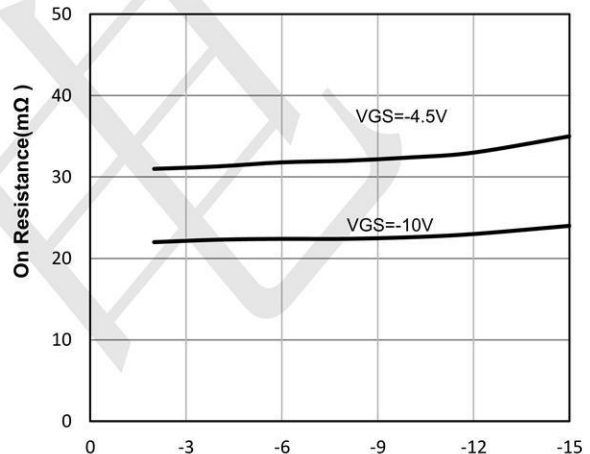

ID, Drain-Source Current (A)  
Fig4. On-Resistance Vs. Drain-Source Current

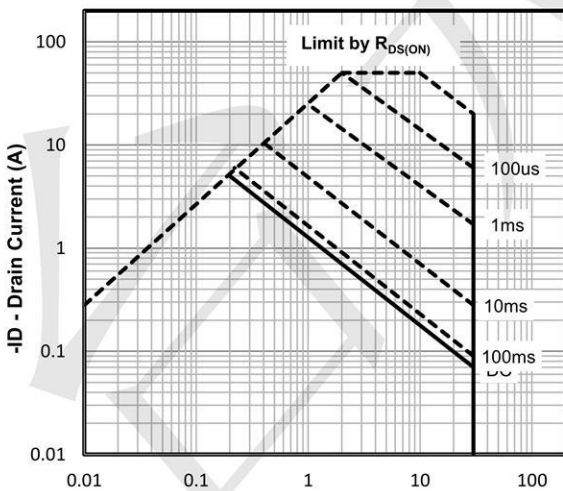

-VDS, Drain -Source Voltage (V)  
Fig7. Maximum Safe Operating Area

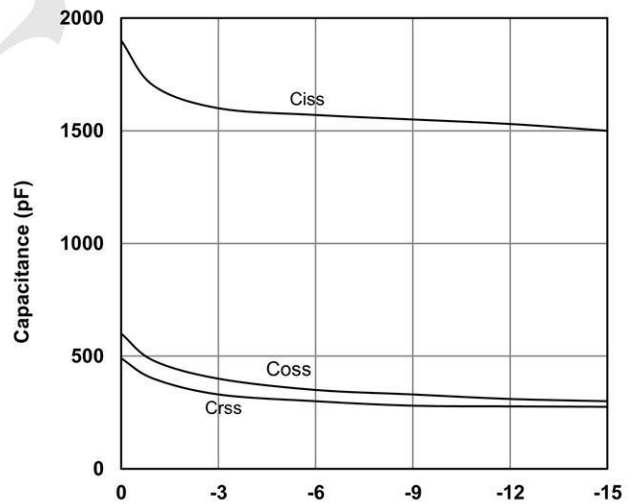

VDS, Drain-Source Voltage (V)  
Fig6. Typical Capacitance Vs. Drain-Source Voltage

## SOP-8 Package Information

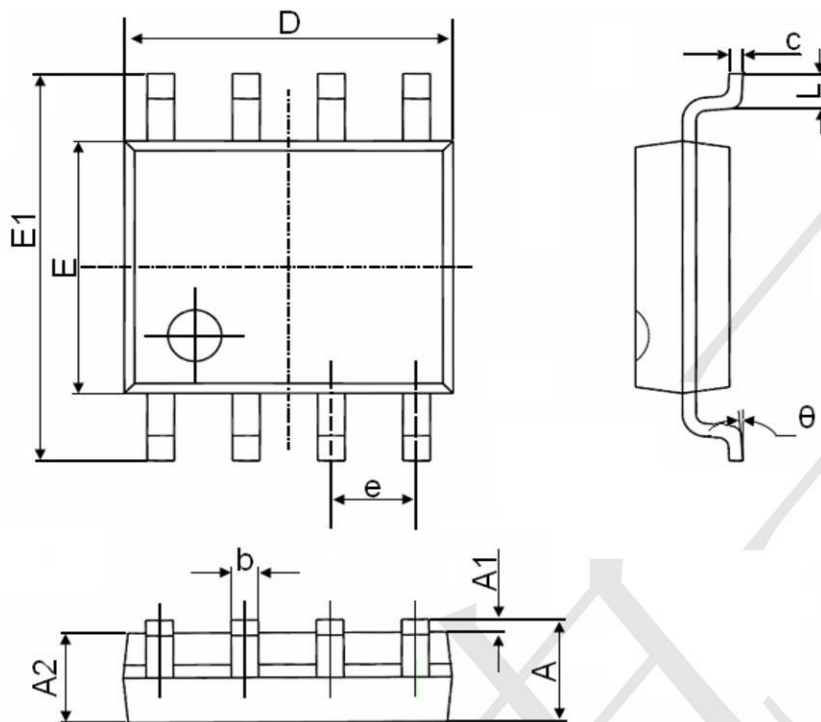

Symbol	Dimensions In Millimeters		Dimensions In Inches	
	Min.	Max.	Min.	Max.
A	1.350	1.750	0.053	0.069
A1	0.100	0.250	0.004	0.010
A2	1.350	1.550	0.053	0.061
b	0.330	0.510	0.013	0.020
c	0.170	0.250	0.006	0.010
D	4.700	5.100	0.185	0.200
E	3.800	4.000	0.150	0.157
E1	5.800	6.200	0.228	0.244
e	1.270(BSC)		0.050(BSC)	
L	0.400	1.270	0.016	0.050
θ	0°	8°	0°	8°

## Marking:

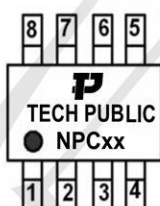

“P” is TECHPUBLIC LOGO  
 “NPC” is Part number, fixed  
 “xx” is internal code