

linear dimension(Tolerances Standard GB/T 14486-2008)								—		
variable range	to 6	over 6 to 10	over 10 to 30	over 30 to 60	over 60 to 100	over 100 to 160	over 160 to	to 10	over 10 to 100	over 100 to
tolerance	±0.20	±0.30	±0.50	±0.70	±1.00	±1.30	±1.60	0.10	0.30	0.60

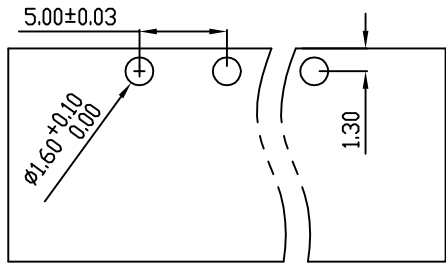

PCB LAYOUT

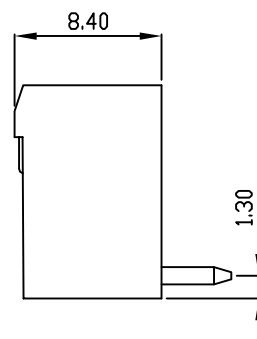
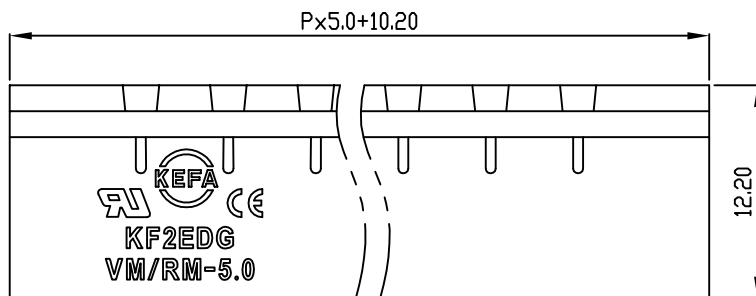
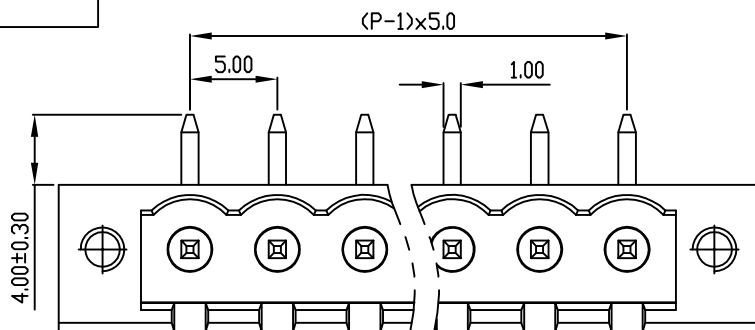

REVISION RECORD				
REV.	DESCRIPTION	ECN No.	APPROVED	DATE
A	新发行		CLF	21.03.15

UL/CUL 技术参数 UL/CUL Technical Data						
等级	Use Group	B	C	D		
额定电压	Rated Voltage [V]	300	-	300		
额定电流	Rated Current [A]	10	-	10		
接线范围	Wire Range					
单/多芯线	Solid/Stranded [AWG]	-				
耐电压	Withstanding Voltage	1600V/1Min				
IEC 技术参数 IEC Technical Data						
过电压类别	Overvoltage Category	III	III	II		
污染等级	Contamination Class	-	2	2		
额定电压	Rated Voltage [V]	-	320	630		
额定电流	Rated Current [A]	-	15	15		
额定冲击电压	Impulse withstand voltagea [KV]	-	4.0	4.0		
导线截面积	Conductor cross section					
硬质/柔性导线	Solid/flexible [mm²]	-				
材料 Material						
绝缘材料	Insulation Material	PA66				
阻燃等级	Imflammability	UL94V-0				
导体材料	Contactive Material	铜合金 Copper alloy				
导体表面镀层	Contactive Coating	镀锡 Tin Plated				
一般参数 Other Data						
间距	Pitch [mm]	5.0				
极数	Poles [P]	2-24				
剥线长度	Stripping Length [mm]	-				
螺丝	Screw/扭矩 Torque(Max) [N.m]	-				
工作温度	Operating temperatur [°C]	-40~+105				
引针尺寸	Pin Dimensions [mm]	4.0				
PCB板孔径	PCB Hole Diameter [mm]	1.6				

DES.	FZM	DATE	21.03.15	单位/UNITS	mm	尺寸/SIZE	A4	比例/SCALE	1:1	第三视角/THIRD ANGLE PROJECTION	版本/REV	A
CHK.	SY	DATE	21.03.15	慈溪市科发电子有限公司 CIXI KEFA ELECTRONIC CO., LTD				名称/TITLE	KF2EDGRM-5.0			
APP.	CLF	DATE	21.03.15									