



# 安徽富信半导体科技有限公司

ANHUI FOSAN SEMICONDUCTOR TECHNOLOGY CO., LTD.

F1A-F1M

## SOD-123FL Fast Recovery Diode 快恢复二极管

### ■ Features 特点

Built-in strain relief 内应力释放  
 Fast Recovery time 快恢复时间  
 Surface mount device 表面贴装器件  
 Case 封装:SOD-123FL



### ■ Maximum Rating 最大额定值

( $T_A=25^{\circ}\text{C}$  unless otherwise noted 如无特殊说明, 温度为  $25^{\circ}\text{C}$ )

Characteristic 特性参数	Symbol 符号	F1A	F1B	F1D	F1G	F1J	F1K	F1M	Unit 单位
Repetitive Peak Reverse Voltage 重复峰值反向电压	$V_{RRM}$	50	100	200	400	600	800	1000	V
DC Reverse Voltage 直流反向电压	$V_R$	50	100	200	400	600	800	1000	V
RMS Reverse Voltage 反向电压均方根值	$V_{R(RMS)}$	35	70	140	280	420	560	700	V
Forward Rectified Current 正向整流电流	$I_F$	1							A
Peak Surge Current 峰值浪涌电流	$I_{FSM}$	30							A
Thermal Resistance J-A 结到环境热阻	$R_{\theta JA}$	80							$^{\circ}\text{C}/\text{W}$
Junction/Storage Temperature 结温/储藏温度	$T_J, T_{stg}$	-50to+150 $^{\circ}\text{C}$							$^{\circ}\text{C}$

### ■ Electrical Characteristics 电特性

( $T_A=25^{\circ}\text{C}$  unless otherwise noted 如无特殊说明, 温度为  $25^{\circ}\text{C}$ )

Characteristic 特性参数	Symbol 符号	F1A-F1G	F1J	F1K-F1M	Unit 单位	Condition 条件
Forward Voltage 正向电压	$V_F$	1.3			V	$I_F=1\text{A}$
Reverse Current 反向电流	$I_R$	5( $T_A=25^{\circ}\text{C}$ ) 100( $T_A=100^{\circ}\text{C}$ )			$\mu\text{A}$	$V_R=V_{RRM}$
Reverse Recovery Time 反向恢复时间	$T_{rr}$	150	250	500	nS	$I_F=0.5\text{A}, I_R=1\text{A}$ $I_{rr}=0.25\text{A}$
Junction Capacitance 结电容	$C_J$	15			pF	$V_R=4\text{V}, f=1\text{MHz}$

## ■ Typical Characteristic Curve 典型特性曲线

FIG.1-TYPICAL FORWARD CHARACTERISTICS

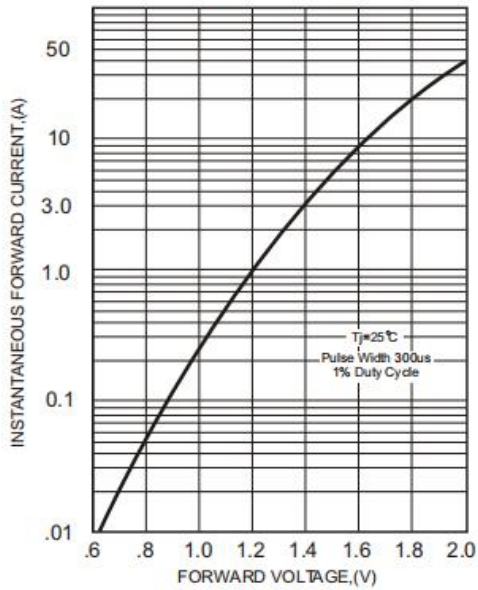

FIG.2-TYPICAL FORWARD CURRENT DERATING CURVE

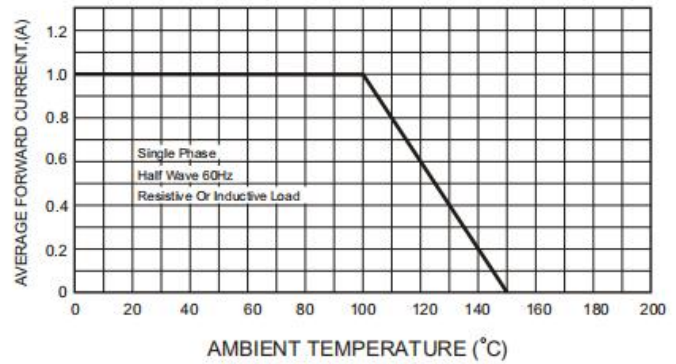

FIG.4-MAXIMUM NON-REPETITIVE FORWARD SURGE CURRENT

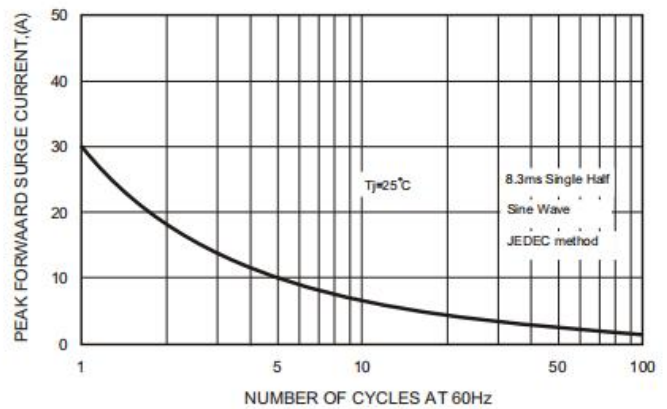
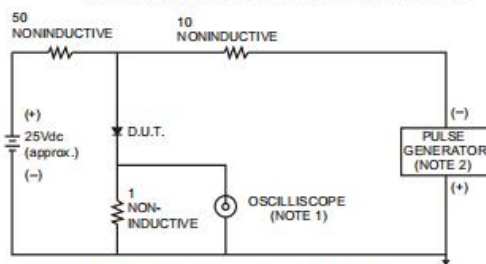

FIG.3- TEST CIRCUIT DIAGRAM AND REVERSE RECOVERY TIME CHARACTERISTICS



NOTES: 1. Rise Time= 7ns max., Input Impedance= 1 megohm, 22pF.

2. Rise Time= 10ns max., Source Impedance= 50 ohms.

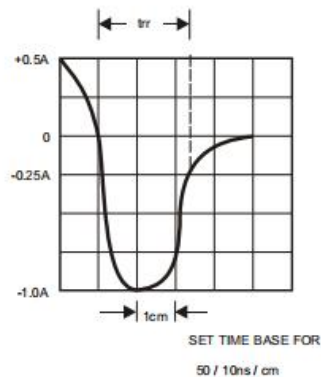
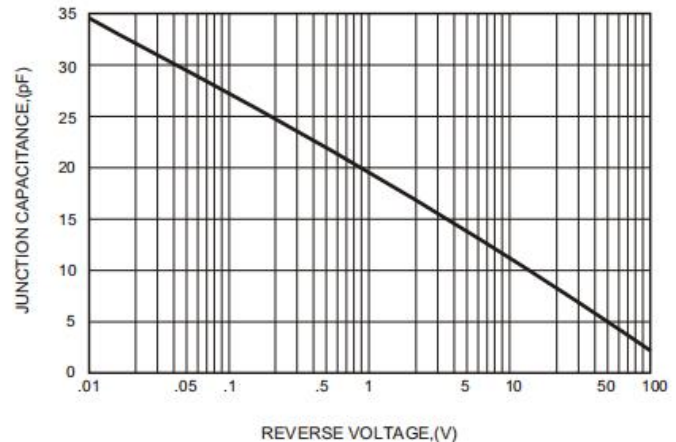
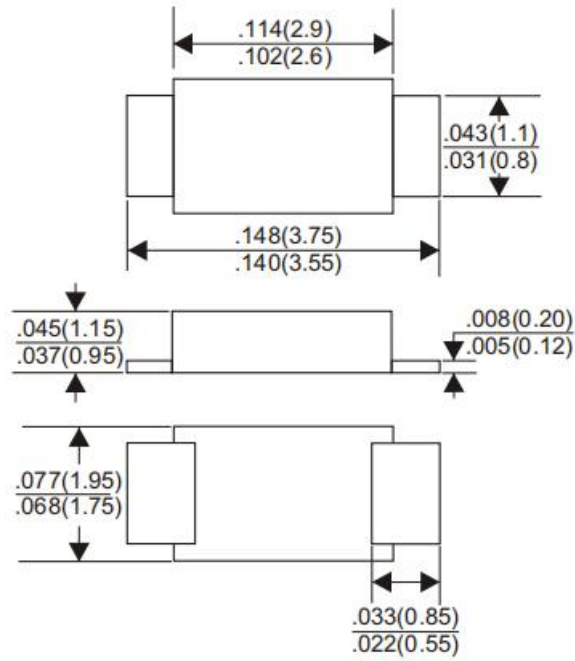

FIG.5-TYPICAL JUNCTION CAPACITANCE



## ■Dimension 外形封装尺寸

SOD-123FL



Dimensions in inches and (millimeters)