

90mΩ, 3.0A/2.5A/2.0A/1.5A/1A/0.6A High-Side Power Switches

General Description

The TP600X is a low voltage, single P-MOSFET high-side power switch, optimized for self-powered and bus-powered Universal Serial Bus (USB) applications. The TP600X equipped with a charge pump circuitry to drive the internal MOSFET switch; the switch's low $R_{DS(ON)}$ 80mΩ, meets USB voltage drop requirements; and a flag output is available to indicate fault conditions to the local USB controller.

Additional features include soft-start to limit inrush current during plug-in, thermal shutdown to prevent catastrophic switch failure from high-current loads, under-voltage lockout (UVLO) to ensure that the device remains off unless there is a valid input voltage present. lower quiescent current as 20uA making this device ideal for portable battery-operated equipment.

The TP600XA is available in SOT23-5L package requiring minimum board space and smallest components.

- Battery-Powered Equipment
- Hot-Plug Power Supplies
- Battery-Charger Circuits

Features

- Wide Input Voltage Ranges : 2.4V to 5.5V
- Compliant to USB Specifications
- Typical $R_{DS(ON)}$:80mΩ
- 1.9V Typical Under-Voltage Lockout (UVLO)
- Low Supply Current :
20uA Typical at Switch on State
1uA Typical at Switch off State
- Current Limiting Protection
- Thermal Shutdown Protection
- Output Can Be Forced Higher Than Input (Off-State)

Applications

- USB Bus/Self Powered Hubs
- USB Peripherals
- ACPI Power Distribution
- PC Card Hot Swap
- Notebook, Motherboard PCs

Package

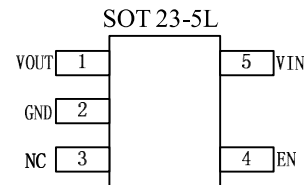

- TP600XA belongs to SOT23-5L

Typical Application Circuit

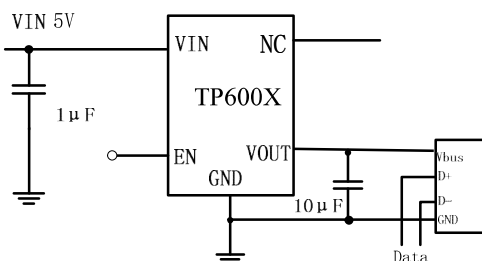
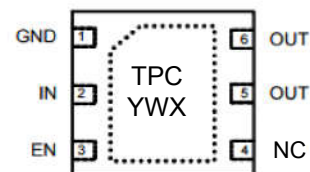

Figure 1. Basic Application Circuit with TP600X

(Top View)



DFN2018

- TP600XC belongs to DFN2018
- TP6001C, "T" indicate TITAN
"P" indicate power switch
"6001" indicate model name
"C" indicate package

Marking: TPC-----indicate TP6001C

YWX-----indicate YEAR,WEEK, CODE

Pin Description

Pin No.	Pin Name	Pin Function
1	VOUT	Output Voltage.
2	GND	Ground.
3	NC	
4	EN /	Chip Enable. one version is available, active-high
5	VIN	Power Input Voltage.

Functional Block Diagram

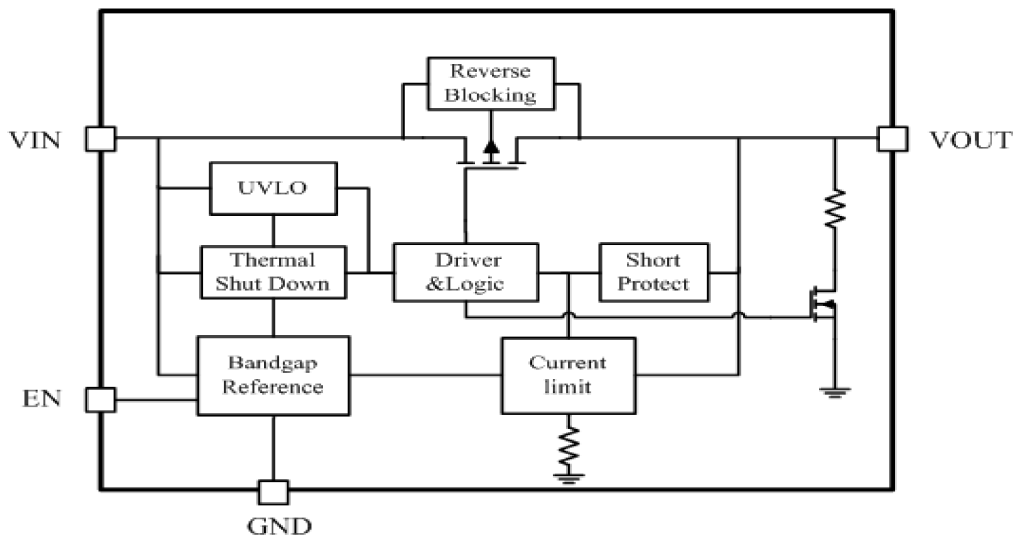

Figure 2. Block Diagram (Output discharge channel not suited for TP600X)

Absolute Maximum Ratings ^(Note 1)

Supply Voltage.....	6.0V
Chip Enable Input Voltage.....	-0.3V to 6.0V
Flag Voltage.....	6.0V
Power Dissipation, P_D @ $T_A = 25^\circ\text{C}$	
SOT 23-5L.....	0.4W
Package Thermal Resistance ^(Note 2)	
SOT 23-5L, θ_{JA}	250°C/W
Junction Temperature ^(Note 3)	125°C
Lead Temperature (Soldering, 10 sec.).....	260°C
Storage Temperature Range.....	-65°C to 150°C
Ambient Temperature Range.....	-40°C to 85°C
ESD Susceptibility	
HBM (Human Body Mode).....	4kV
MM (Machine Mode).....	200V

Electrical Characteristics ^(Note 4)

($V_{in}=5V, C_{in}=C_{out}=1\mu F, T_A=25^\circ\text{C}$, unless otherwise specified)

Parameter		Condition	Min	Typ	Max	Units
Supply Voltage			2.5		5.5	V
Switch On Resistance	TP6001	$V_{IN} = 5V, I_{OUT} = 0.6A$			100	mΩ
	TP6002	$V_{IN} = 5V, I_{OUT} = 1A$			100	mΩ
	TP6003	$V_{IN} = 5V, I_{OUT} = 1.5A$			100	mΩ
	TP6004	$V_{IN} = 5V, I_{OUT} = 2A$			100	mΩ
	TP6005	$V_{IN} = 5V, I_{OUT} = 2.5A$			100	mΩ
	TP6006	$V_{IN} = 5V, I_{OUT} = 3A$			100	mΩ
Supply Current		Switch on, $V_{OUT} = OPEN$		20	30	μA
		Switch off, $V_{OUT} = OPEN$		0.1	1	μA
EN / Threshold		Logic-Low Voltage, $V_{IN} = 2.5V$ to $5.5V$			0.8	V
		Logic-High Voltage, $V_{IN} = 2.5V$ to $5.5V$	2.0			V
EN/ Input Current		$V_{EN} = 0$ to $5.5V$		0.0 1		μA
Output Leakage Current		$V_{EN} = 0V, R_{LOAD} = 0Ω$		0.5	10	μA
Output Turn-On Rise Time		10% to 90% of V_{out} rising		400		us
Rated Current	TP6001			0.6		A
	TP6002			1.0		
	TP6003			1.5		
	TP6004			2.0		
	TP6005			2.5		
	TP6006			3.0		
Short Circuit Fold-back Current (Hysteresis)	TP6001	$V_{OUT} = 0V$, measured prior to thermal shutdown		0.15		A
	TP6002			0.2		
	TP6003			0.5		
	TP6004			0.7		
	TP6005			0.9		
	TP6006			1.2		
Current Limit	TP6001	Current Ramp ($<0.1A/ms$) on V_{OUT}	0.72	0.85	0.97	A
	TP6002		1.27	1.5	1.73	
	TP6003		1.78	2.1	2.42	
	TP6004		2.5	2.88	3.3	
	TP6005		3.35	3.85	4.4	
	TP6006		4.45	5.1	5.9	

Shutdown Pull-Low Resistance	$V_{EN}=0V$		75	150	Ω
Under-Voltage Lockout	V_{IN} increasing		2.0		V
Under-Voltage Hysteresis	V_{IN} decreasing		0.1		V
Thermal Shutdown Protection			130		$^{\circ}C$
Thermal Shutdown Hysteresis			20		$^{\circ}C$

Note 1: Absolute Maximum Ratings are those values beyond which the life of a device may be impaired.

Note 2: Thermal Resistance is specified with approximately 1 square of 1 oz copper.

Note 3: θ_{JA} is measured in the natural convection at $T_A = 25^{\circ}C$ on a low effective single layer thermal conductivity test board of JEDEC 51-3 thermal measurement standard.

Note 4: 100% production test at $+25^{\circ}C$. Specifications over the temperature range are guaranteed by design and characterization. The device is not guaranteed to function outside its operating conditions.

Typical Characteristics

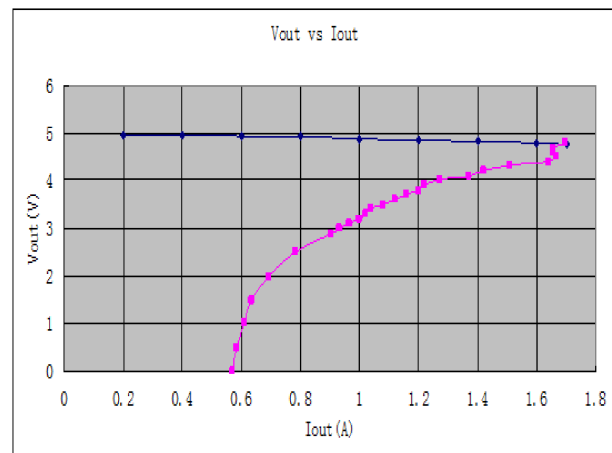
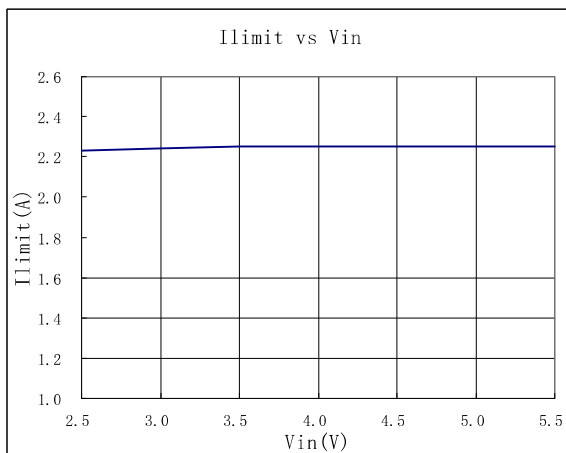
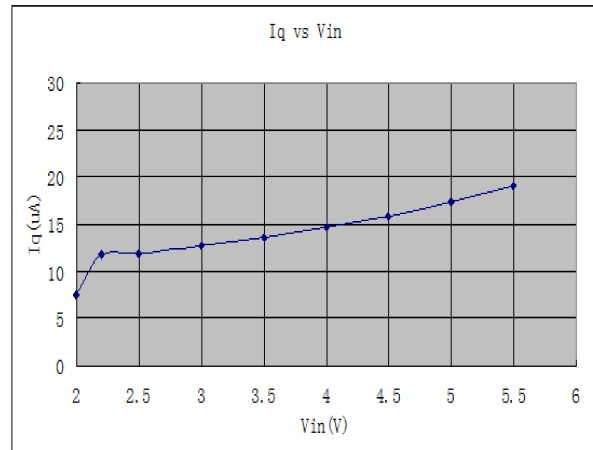
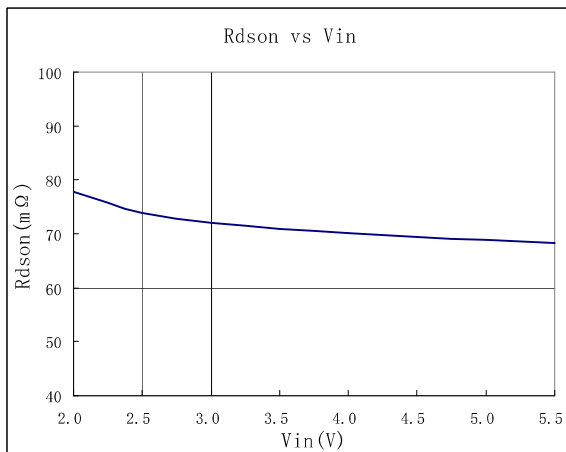

Short Circuit Fold-Back Current
CH2:VO, CH4:IO

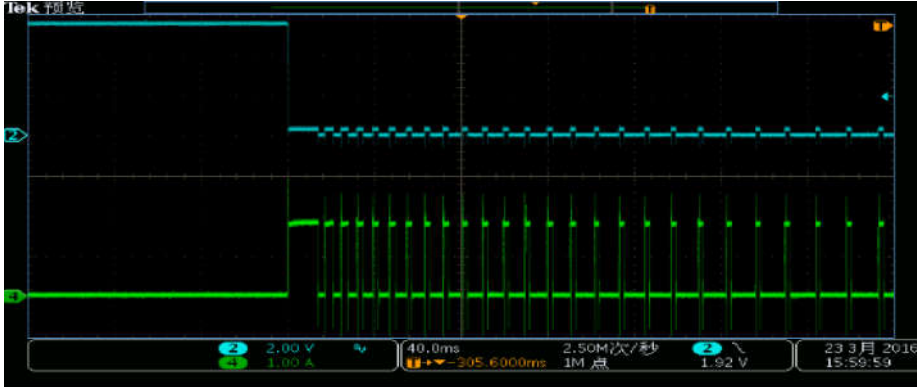

Turn On
CH1:EN, CH2:VO

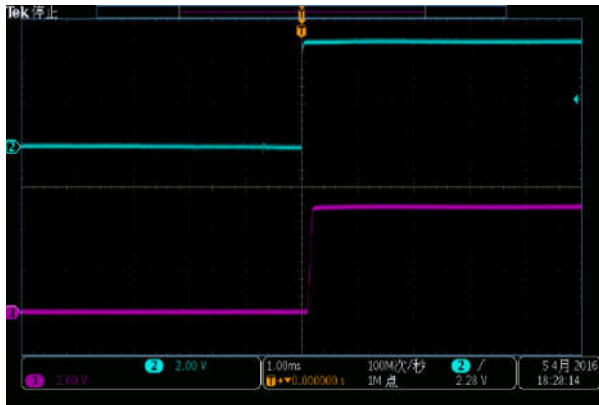

Turn Off
CH1:EN, CH2:VO

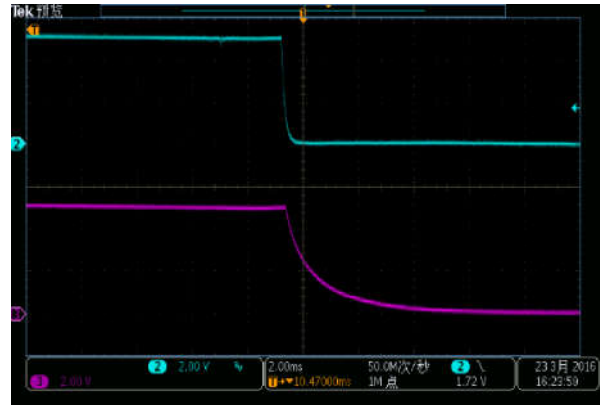

UVLO at Rising
CH2:VIN, CH3:VO

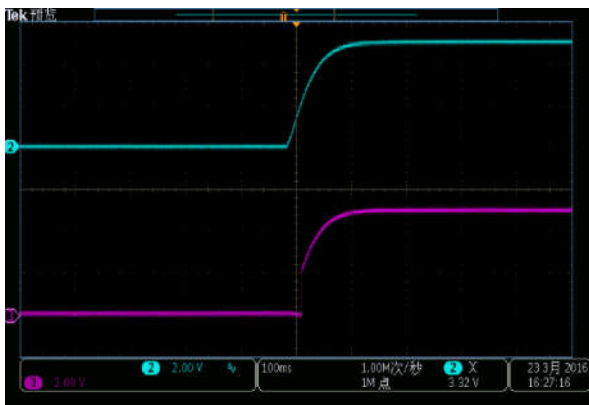

UVLO at Falling
CH2:VIN, CH3:VO

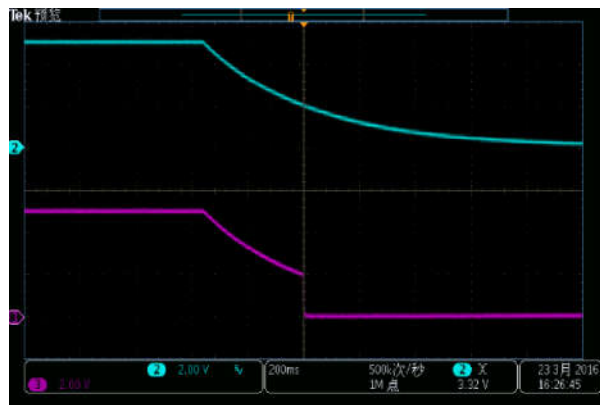

Ordering Information

Part Number	Mark	Package	Description	Quantity Per Reel
TP600XA	TP600X	SOT23-5L	Active High	3000
TP600XC	TPC YWX	DFN2018	Active High	3000

(1) X : 1-6

(2) Marking: TPC-----indicate TP6001C

YWX-----indicate YEAR,WEEK,CODE

Applications Information

The TP600X are single P-MOSFET high-side power switches with enable input, optimized for self-powered and bus-powered Universal Serial Bus (USB) applications. The TP600X series are equipped with a charge pump circuitry to drive the internal P-MOSFET switch; the switch's low $R_{DS(ON)}$, 80m Ω , meets USB voltage drop requirements; and a flag output is available to indicate fault conditions to the local USB controller.

Input and Output

VIN (input) is the power source connection to the internal circuitry and the drain of the MOSFET. VOUT (output) is the source of the MOSFET. In a typical application, current flows through the switch from VIN to VOUT toward the load. If VOUT is greater than VIN, current will flow from VOUT to VIN since the MOSFET is bidirectional when on.

Unlike a normal MOSFET, there is no a parasitic body diode between drain and source of the MOSFET, the TP600X prevents reverse current flow if VOUT being externally forced to a higher voltage than VIN when the output disabled ($V_{EN} < 0.8V$).

Enable

The switch will be disabled when the EN/ pin is in a logic low/high condition. During this condition, the internal circuitry and MOSFET are turned off, reducing the supply current to 0.1uA typical. Floating the EN/ may cause unpredictable operation. EN should not be allowed to go negative with respect to GND. The EN/ pin may be directly tied to VIN (GND) to keep the part on.

UVLO

Under-voltage lockout (UVLO) prevents the MOSFET switch from turning on until input voltage exceeds approximately 2.0V. If input voltage drops below approximately 1.9V, UVLO turns off the MOSFET switch

Current Limiting and Short-Circuit Protection

The current limit circuitry prevents damage to the MOSFET switch and the hub downstream port but can deliver load current up to the current limit threshold.

When a heavy load or short circuit is applied to an enabled switch, a large transient current may flow until the current limit circuitry responds. Once this current limit threshold is exceeded the device enters constant current mode until the thermal shutdown occurs or the fault is removed.

Thermal Shutdown

Thermal shutdown is employed to protect the device from damage if the die temperature exceeds approximately 130°C. If enabled, the switch automatically restarts when the die temperature falls 20°C. The output will continue to cycle on and off until the device is disabled or the fault is removed.

Input Capacitor

A 1 μ F low-ESR ceramic capacitor from VIN to GND, located at the device is strongly recommended to prevent the input voltage drooping during hot-plug events. However, higher capacitor values will further reduce the voltage droop on the input. Furthermore, without the bypass capacitor, an output short may cause sufficient ringing on the input (from source lead inductance) to destroy the internal control circuitry. The input transient must not exceed 6.0V of the absolute maximum supply voltage even for a short duration.

Output Capacitor

A low-ESR 150 μ F aluminum electrolytic or tantalum between VOUT and GND is strongly recommended to meet the 330mV maximum droop requirement in the hub V_{BUS} (Per USB 2.0, output ports must have a minimum 120 μ F of low-ESR bulk capacitance per hub). Standard bypass methods should be used to minimize inductance and resistance between the bypass capacitor and the downstream connector to reduce EMI and decouple voltage droop caused when downstream cables are hot-insertion transients. Ferrite beads in series with V_{BUS}, the ground line and the 0.1 μ F bypass capacitors at the power connector pins are recommended for EMI and ESD protection. The bypass capacitor itself should have a low dissipation factor to allow decoupling at higher frequencies.

Layout Considerations

For best performance of the TP600X series, the following guidelines must be strictly followed:

1. Input and output capacitors should be placed close to the IC and connected to ground plane to reduce noise coupling.
2. The GND should be connected to a strong ground plane for heat sink.
3. Keep the main current traces as possible as short and wide.

Package Information

SOT23-5L Package (Unit: mm)

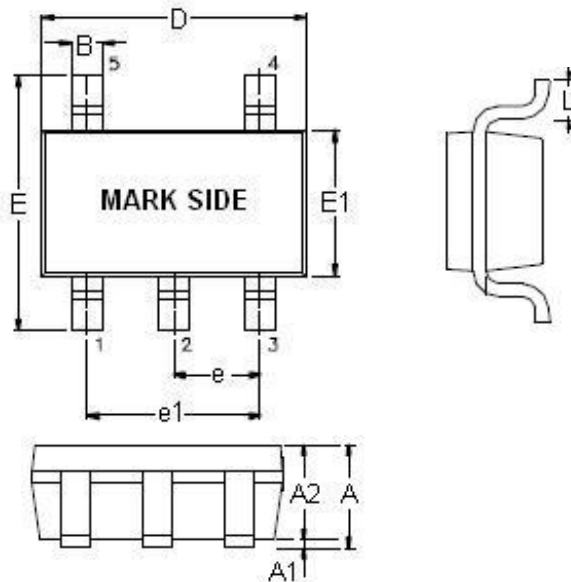

SYMBOLS UNIT	DIMENSION IN MILLIMETER	
	MIN	MAX
A	0.90	1.45
A1	0.00	0.15
A2	0.90	1.30
B	0.30	0.50
D	2.80	3.00
E	2.60	3.00
E1	1.50	1.70
e	0.90	1.00
e1	1.80	2.00
L	0.30	0.60

Note : Followed From JEDEC MO-178-C.

Carrier Dimensions

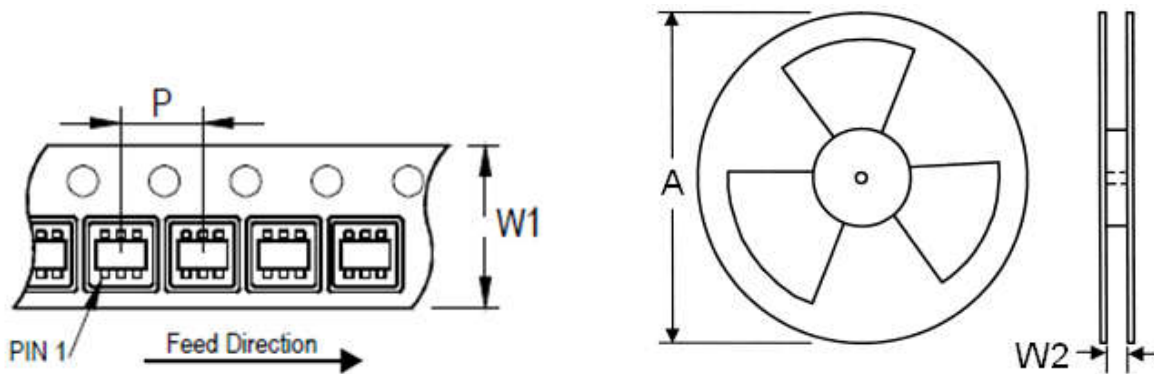

Tape Size (W1) mm	Pocket Pitch (P) mm	Reel Size (A)		Reel Width (W2) mm	Empty Cavity Length mm	Units per Reel
		in	mm			
8	4	7	180	8.4	300~1000	3,000

Package Information

SOT23-6L Package (Unit: mm)

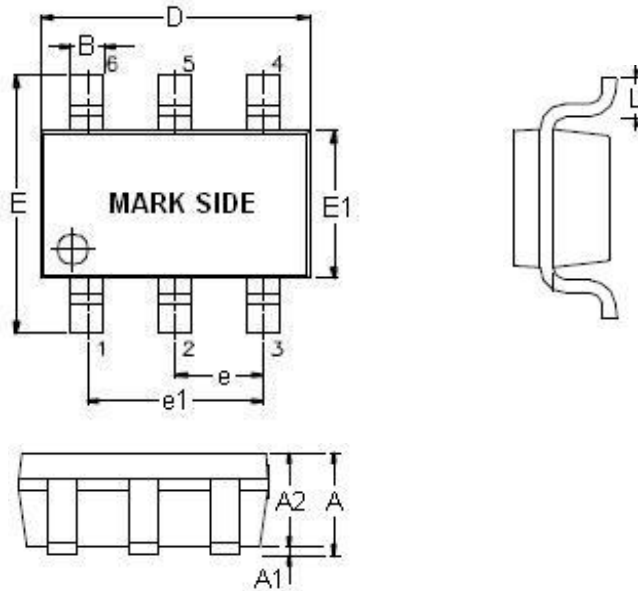

SYMBOLS UNIT	DIMENSION IN MILLIMETER	
	MIN	MAX
A	0.90	1.45
A1	0.00	0.15
A2	0.90	1.30
B	0.30	0.50
D	2.80	3.00
E	2.60	3.00
E1	1.50	1.70
e	0.90	1.00
e1	1.80	2.00
L	0.30	0.60

Note : Followed From JEDEC MO-178-C.

Carrier Dimensions

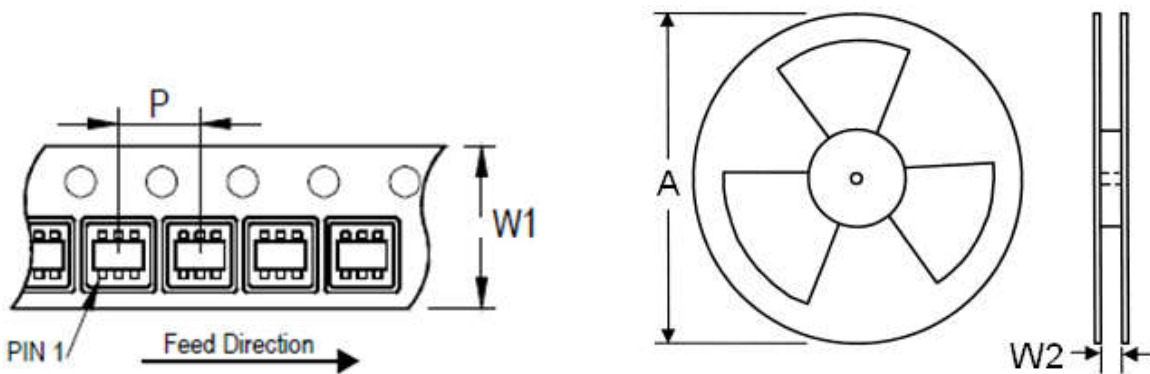

Tape Size (W1) mm	Pocket Pitch (P) mm	Reel Size (A)		Reel Width (W2) mm	Empty Cavity Length mm	Units per Reel
		in	mm			
8	4	7	180	8.4	300~1000	3,000

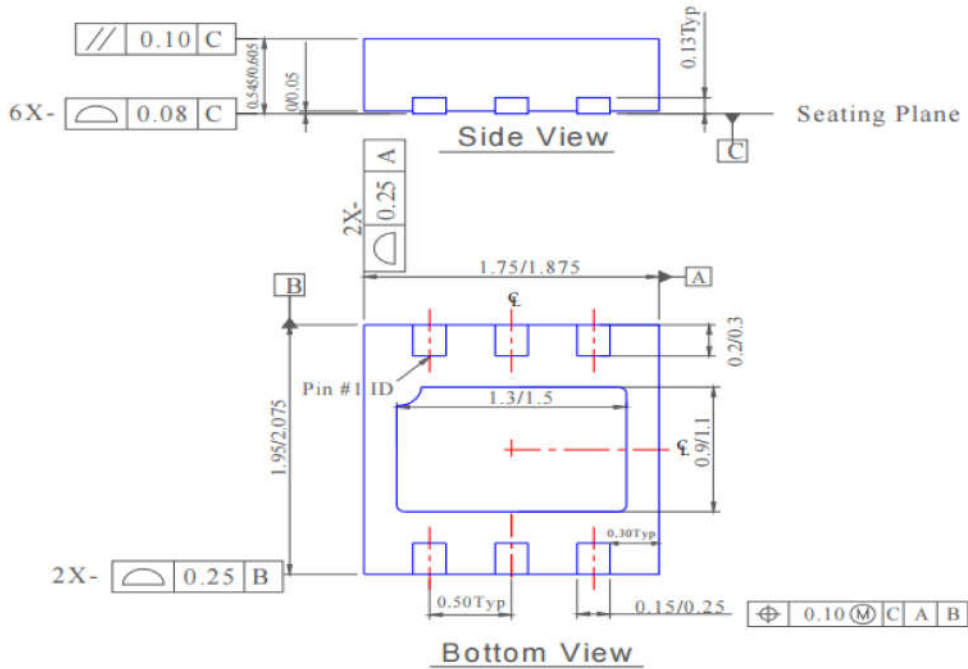
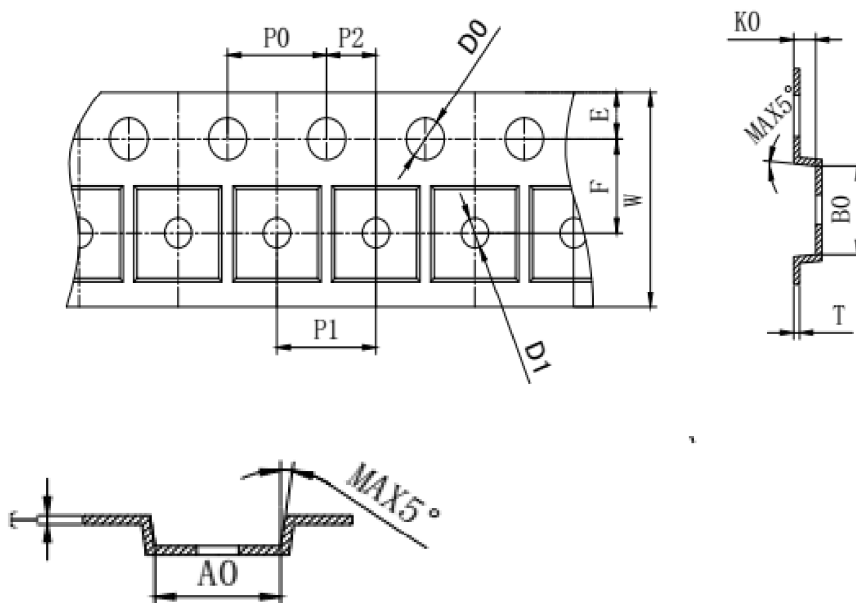
Package Type: DFN2018

Carrier Dimensions

SYMBOL	A0	B0	K0	P0	P1	P2
SPEC	2.20±0.05	2.20±0.05	0.75±0.05	4.00±0.10	4.00±0.10	2.00±0.05
SYMBOL	T	E	F	D0	D1	W
SPEC	0.20±0.02	1.75±0.10	3.50±0.05	1.55±0.05	1.00 ^{+0.10} ₋₀	8.00 ^{+0.30} _{-0.10}