

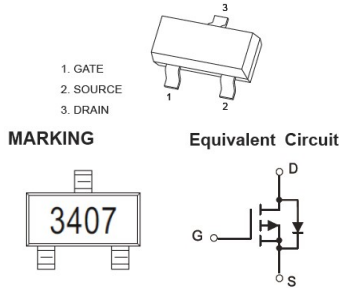

V(BR)DSS	RDS(ON)MAX	ID
-30V	60mΩ@-10V	-4.1A
	87mΩ@-4.5V	

SOT-23



特征 Features

- High dense cell design for extremely low RDS(on).
- Exceptional on-resistance and maximum DC current capability.
- Load/Power Switching.
- Interfacing Switching

机械数据 Mechanical Data

- 封装: SOT-23 封装 SOT-23 Small Outline Plastic Package.
- 环氧树脂 UL 易燃等级 Epoxy UL: 94V-0.
- 安装位置: 任意 Mounting Position: Any.

极限值和温度特性(TA = 25°C 除非另有规定)

Maximum Ratings & Thermal Characteristics (Ratings at 25°C ambient temperature unless otherwise specified.)

参数 Parameters	符号 Symbol	数值 Value	单位 Unit
Drain-Source Voltage	V _{DS}	-30	V
Gate-Source Voltage	V _{GS}	±20	V
Continuous Drain Current	I _D	-4.1	A
Power Dissipation	P _D	350	mW
Junction Temperature	T _j	150	°C
Storage Temperature	T _{stg}	-50-+150	°C
Thermal Resistance From Junction to Ambient (note 2)	R _{θJA}	357	°C/W

电特性 (TA = 25°C 除非另有规定)

Electrical Characteristics (Ratings at 25°C ambient temperature unless otherwise specified).

参数 Parameter	符号 Symbols	测试条件 Test Condition	界限 Limits			单位 Unit
			Min	Typ	Max	
Off characteristics						
Drain-Source Breakdown Voltage	V(BR)DSS	V _{GS} =0V, I _D =-250uA	-30			V
Zero Gate Voltage Drain current	I _{DSS}	V _{DS} =-24V, V _{GS} =0V			-1	uA
Gate-body Leakage	I _{GSS}	V _{DS} =±20V, V _{GS} =0V			±100	nA
On characteristics						
Drain-Source On-Resistance (note 1)	RDS(ON)	V _{GS} =-10V, I _D =-4.1A		50	60	mΩ
		V _{GS} =-4.5V, I _D =-3A		68	87	
Forward trans conductance	g _{fs}	V _{DS} =-5V, I _D =-4A	5.5			S
Gate-Threshold voltage*	V _{GS(th)}	V _{DS} =V _{GS} , I _D =-250uA	-1.0	-1.4	-3.0	V
Dynamic characteristics (note 2)						
Input capacitance	C _{iss}	V _{DS} =-15V, V _{GS} =0V, f=1MHz		700		pF
Output capacitance	C _{oss}			120		
Reverse Transfer capacitance	C _{rss}			75		
Switching characteristics (note 2)						
Turn-on Time	t _{d(on)}	V _{GS} =-10V, R _L =3.6Ω, V _{DS} =-15V, R _{GEN} =3Ω		8.6		ns
Rise time	t _r			5.0		
Turn-off Time	t _{d(off)}			28.2		
Fall time	t _f			13.5		
Drain-source diode characteristics and maximum ratings						
Diode forward voltage(note 1)	V _{SD}	I _S =-1A, V _{GS} =0V			-1.0	V

Notes: 1. Pulse Test: Pulse Width ≤300us, Duty Cycle≤2%.
2. These parameters have no way to verify.





Typical characteristics

Output Characteristics

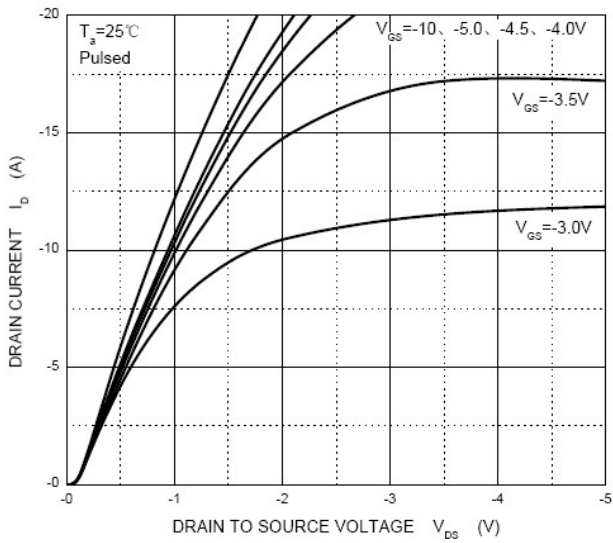

Transfer Characteristics

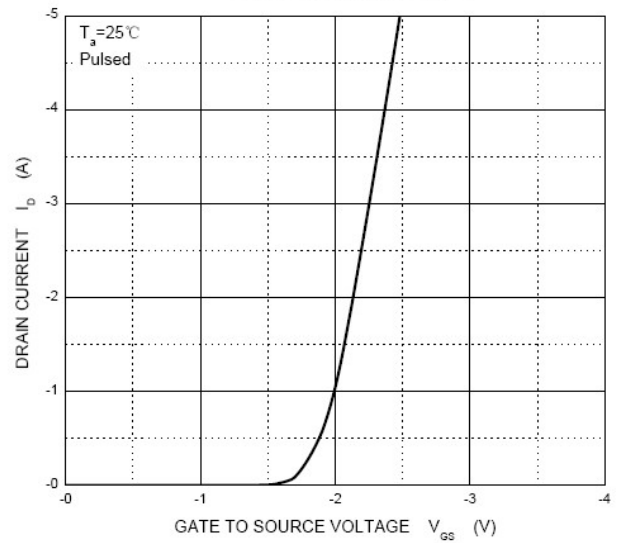

$R_{DS(ON)}$ — I_d

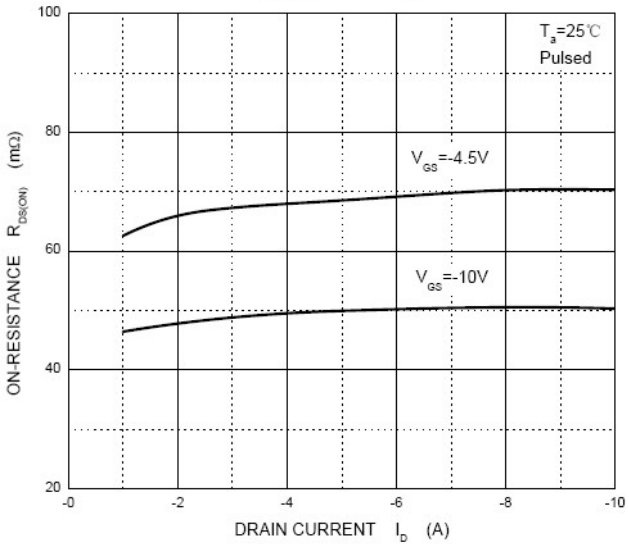

$R_{DS(ON)}$ — V_{GS}

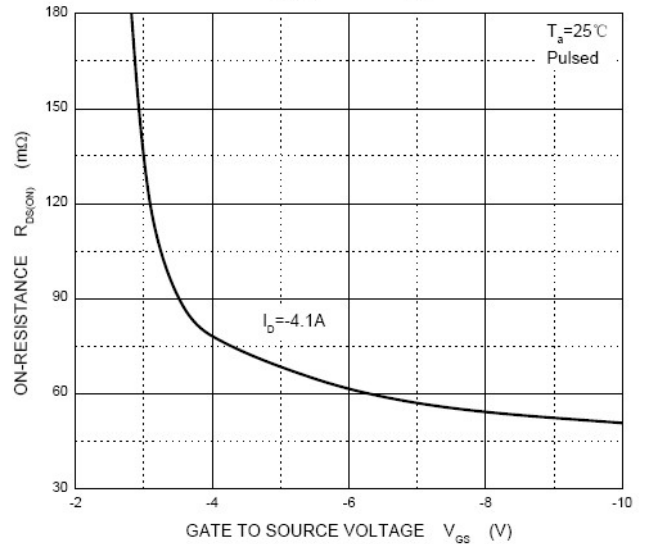

I_s — V_{SD}

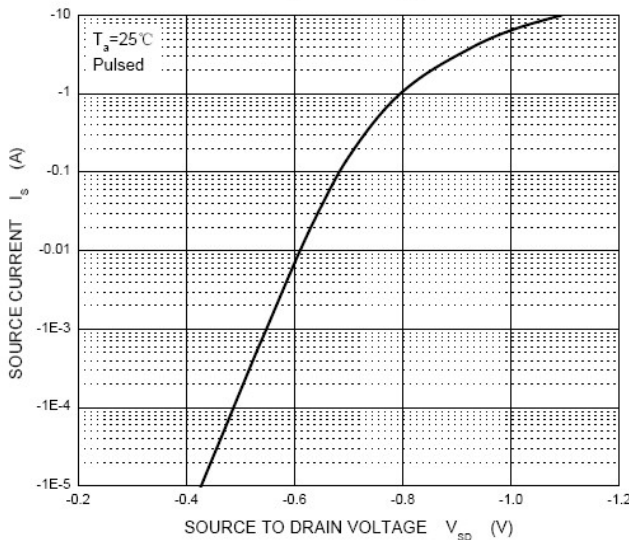



AO3407 P-CHANNEL ENHANCEMENT MOSFET

SOT-23 PACKAGE OUTLINE Plastic surface mounted package

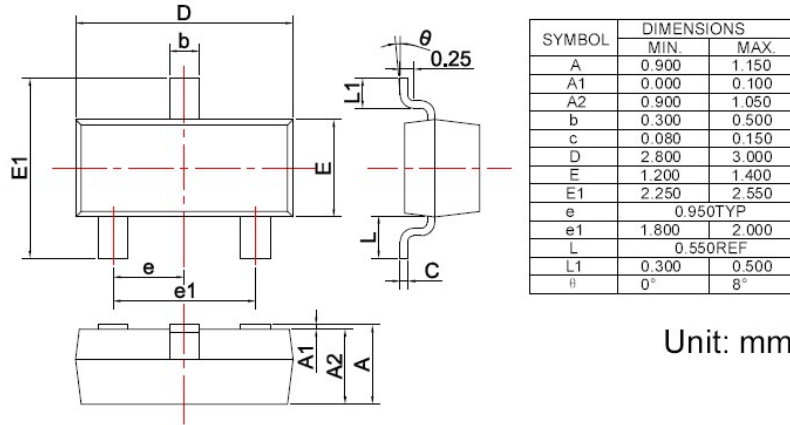

焊盘设计参考 Precautions: PCB Design

Recommended land dimensions for SOT-23 diode. Electrode patterns for PCBs

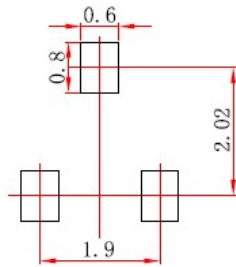

- Note:
1. Controlling dimension; in millimeters.
 2. General tolerance: ±0.05mm.
 3. The pad layout is for reference purposes only.