

修订 REV	标记 MARK	修改摘要 REVISION DESCRIPTION	签名 SIGNATURE	日期 DATE
AO		NEW RELEASE	黄艳兰	2013-06-11

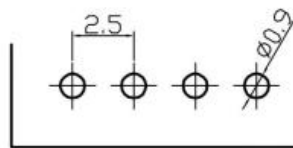

P. C. B LAYOUT

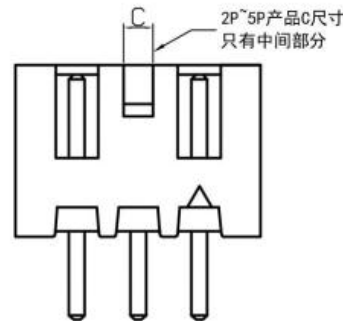
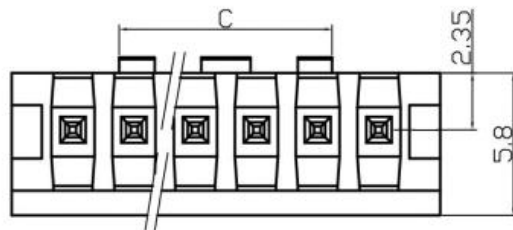
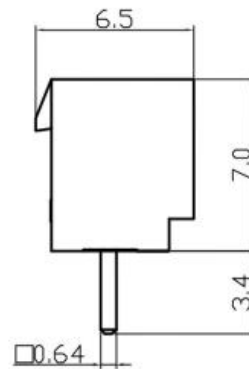
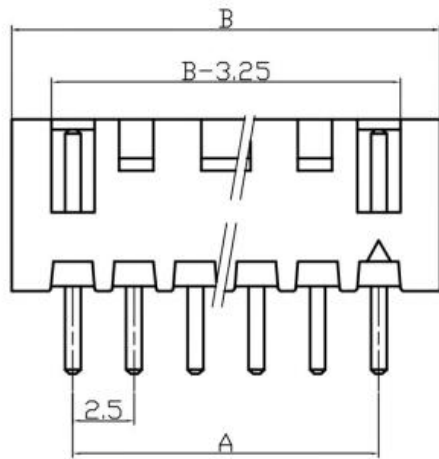
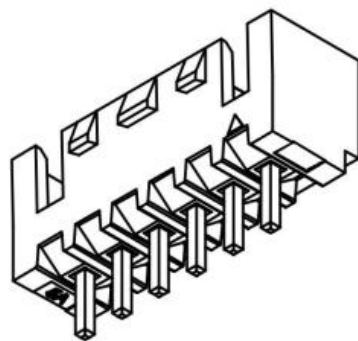

PIN	尺寸 (mm)		
	A	B	C
2P	2.50	7.50	2.3
3P	5.00	10.00	2.3
4P	7.50	12.50	2.3
5P	10.00	15.00	2.3
6P	12.50	17.50	9.6
7P	15.00	20.00	12.1
8P	17.50	22.50	14.6
9P	20.00	25.00	17.1
10P	22.50	27.50	19.6
11P	25.00	30.00	22.1
12P	27.50	32.50	24.6
13P	30.00	35.00	27.1
14P	32.50	37.50	29.6
15P	35.00	40.00	31.1
16P	37.50	42.50	33.6
17P	40.00	45.00	36.1
18P	42.50	47.50	38.6
19P	45.00	50.00	41.1
20P	47.50	52.50	43.6

2	Wafer 针	Brass Tin 黄铜镀锡	N	
1	Housing 基座	PA66 (UL94V-0)	1	White (白色)



深圳市华德共创科技有限公司

Shenzhen Huade co-create Technology Co., LTD

TEL : 0755-27111225 FAX : 0755-29940187

-TOLERANCES- UNLESS OTHERWISE SPECIFIED 公差参数表				 		TITLE: 产品名称: XHB2.5 带扣直针			
X.X	±0.30	X.X°	±3°	APPD: 核准:		PART NO: 产品编号: HDGC2512WV-XP			
X.XX	±0.30	X.XX°	±2°	CHECK: 校对: 王建业		DATE	SCALE	UNIT	CODE NUMBER
X.XXX	±0.10	X.XXX°	±1°	DRAW: 绘图: 黄艳兰		2013-06-11	1:1	mm	A126