

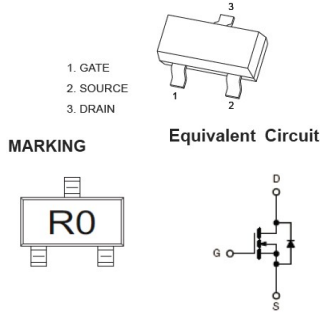

V(BR)DSS	RDS(ON)MAX	ID
30V	35mΩ@10V	5.8A
	40mΩ@4.5V	
	52mΩ@2.5V	

SOT-23



特征 Features

- High dense cell design for extremely low RDS(on).
- Exceptional on-resistance and maximum DC current capability.
- Load/Power Switching.
- Interfacing Switching

机械数据 Mechanical Data

- 封装: SOT-23 封装 SOT-23 Small Outline Plastic Package.
- 环氧树脂 UL 易燃等级 Epoxy UL: 94V-0.
- 安装位置: 任意 Mounting Position: Any.

极限值和温度特性(TA = 25°C 除非另有规定)

Maximum Ratings & Thermal Characteristics (Ratings at 25°C ambient temperature unless otherwise specified.)

参数 Parameters	符号 Symbol	数值 Value	单位 Unit
Drain-Source Voltage	V _{DS}	30	V
Gate-Source Voltage	V _{GS}	±12	V
Continuous Drain Current	I _D	5.8	A
Drain Current-Pulsed(note 1)	I _{DM}	30	
Power Dissipation	P _D	350	mW
Junction Temperature	T _j	150	°C
Storage Temperature	T _{stg}	-50-+150	°C
Thermal Resistance From Junction to Ambient (note 2)	R _{θJA}	357	°C/W

电特性 (TA = 25°C 除非另有规定)

Electrical Characteristics (Ratings at 25°C ambient temperature unless otherwise specified.)

参数 Parameter	符号 Symbols	测试条件 Test Condition	界限 Limits			单位 Unit
			Min	Typ	Max	
Off characteristics						
Drain-Source Breakdown Voltage	V(BR)DSS	V _{GS} =0V, I _D =250uA	30			V
Zero Gate Voltage Drain current	I _{DSS}	V _{DS} =24V, V _{GS} =0V			1	uA
Gate-body Leakage	I _{GSS}	V _{DS} =12V, V _{GS} =0V			±100	nA
On characteristics						
Drain-Source On-Resistance (note 3)	RDS(ON)	V _{GS} =10V, I _D =5.8A			35	mΩ
		V _{GS} =4.5V, I _D =5A			40	
		V _{GS} =2.5V, I _D =4A			52	
Forward trans conductance	g _{fs}	V _{DS} =5V, I _D =5A	8			S
Gate-Threshold voltage*	V _{GS(th)}	V _{DS} =V _{GS} , I _D =250uA	0.7		1.4	V
Dynamic characteristics (note 4,5)						
Input capacitance	C _{iss}	V _{DS} =15V, V _{GS} =0V, f=1MHz			1050	pF
Output capacitance	C _{oss}				99	
Reverse Transfer capacitance	C _{rss}				77	
Gate resistance	R _g	V _{DS} =0V, V _{GS} =0V, f=1MHz			3.6	Ω
Switching characteristics (note 4,5)						
Turn-on Time	td(on)	V _{GS} =10V, R _L =2.7Ω, V _{DS} =15V, R _{GEN} =3Ω			5	ns
Rise time	tr				7	
Turn-off Time	td(off)				40	
Fall time	tf				6	
Drain-source diode characteristics and maximum ratings						
Diode forward voltage	V _{SD}	I _S =1A, V _{GS} =0V			1.0	V

Notes: 1. Repetitive Rating: Pulse width limited by maximum junction temperature.

2. Surface Mounted on FR4 Board, t<5 sec.

3. Pulse Test: Pulse Width ≤300us, Duty Cycle≤2%.

4. Guaranteed by design, not subject to production testing.



JX3400 N-CHANNEL ENHANCEMENT MOSFET

Typical characteristics

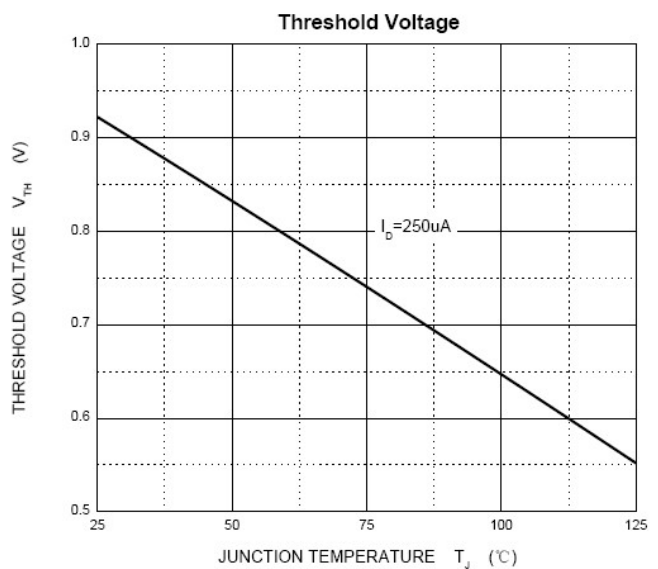
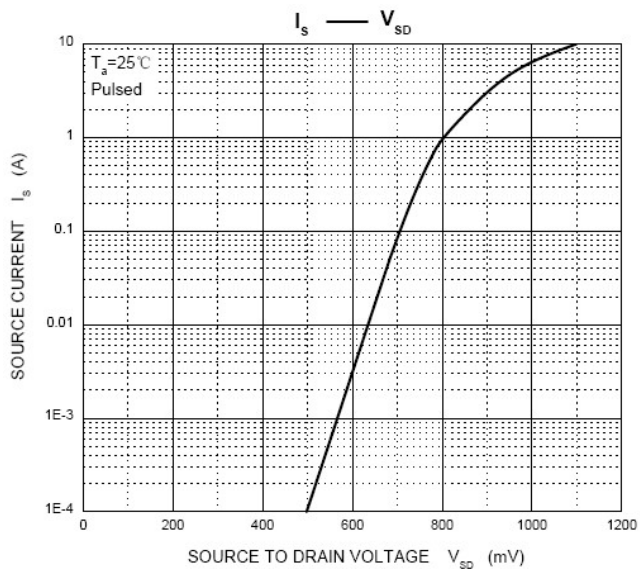
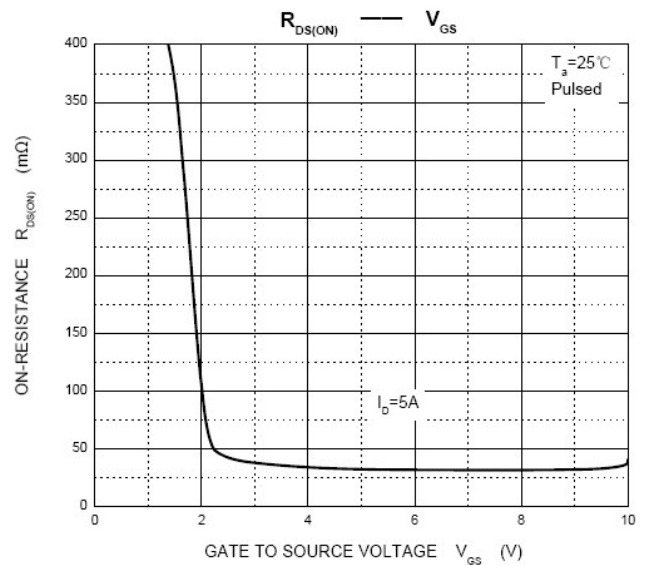
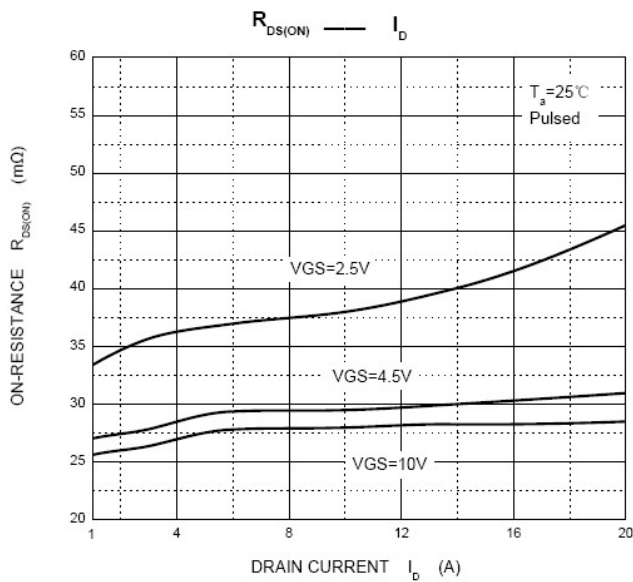
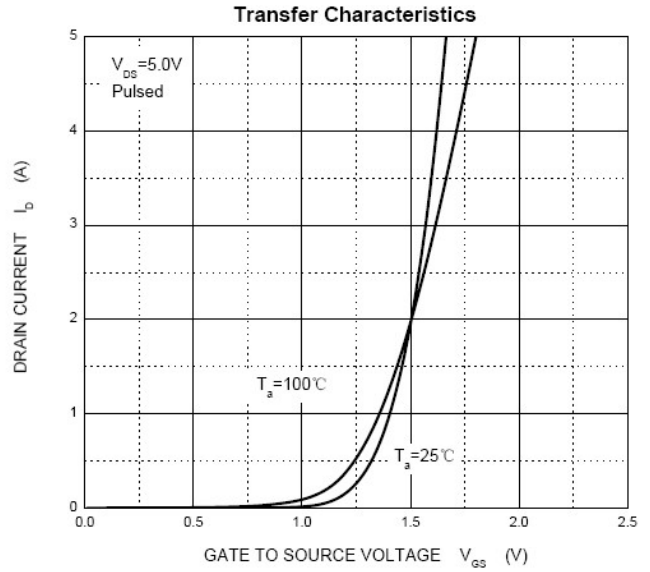
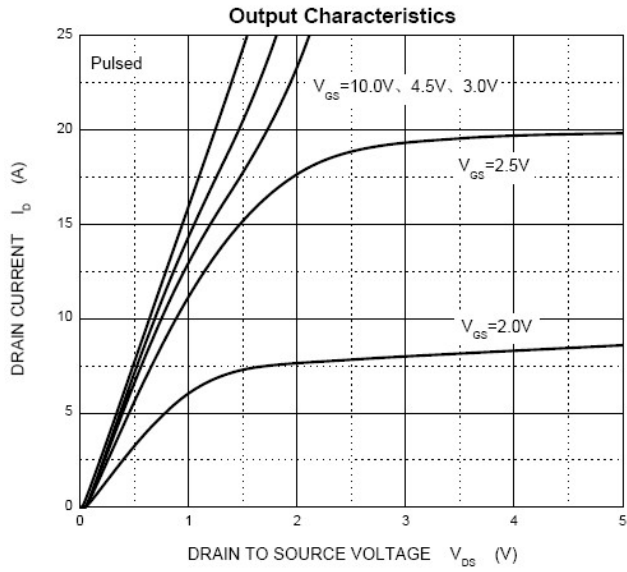



SOT-23 Package Information

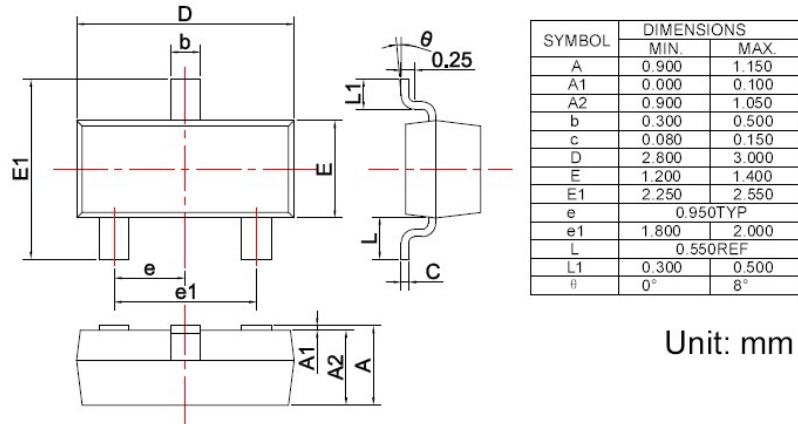

焊盘设计参考 Precautions: PCB Design

Recommended land dimensions for SOT-23 diode. Electrode patterns for PCBs

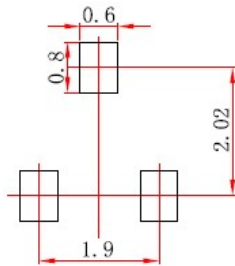

- Note:
1. Controlling dimension: in millimeters.
 2. General tolerance: $\pm 0.05\text{mm}$.
 3. The pad layout is for reference purposes only.