

CIRCUIT DIAGRAM
电路图

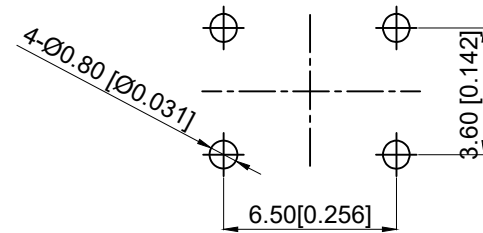

PCB LAND DIMENSION
PCB板焊盘尺寸

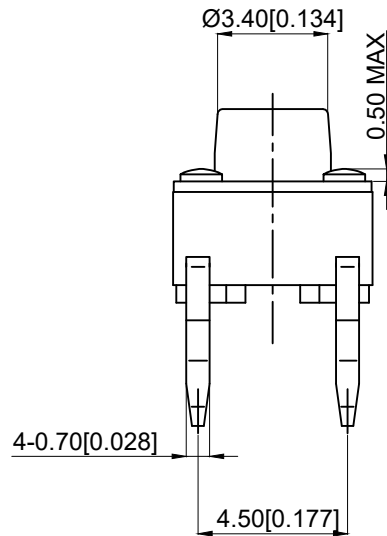
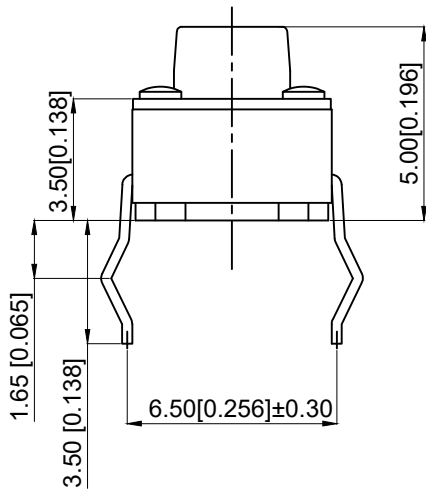

SPECIFICATION

规范
Rating: 50mA.12V DC
额定值: 50mA.12V DC
Insulation resistance: 100MΩ min.100V DC
绝缘电阻: 100MΩ min.100V DC
Dielectric strength: 250V AC for 1 min
介电强度: 250V AC 1分钟
Contact resistance:100mΩ max

Travel: 0.25±0.1mm
行程: 0.25±0.1mm
Lifetime:600000 times
寿命: 600000 times
Operating force:350±50gf
操作力: 350±50gf
Operating temperature rang:-30°Cto + 85°C
工作温度范围: -30°Cto + 85°C

5	Terminal 端子	PA66	1	Ag plating 镀银
4	Base 底座	LCP	1	Black 黑色
3	Contact 弹片	SUS	1	Ag plating 镀银
2	Stem 按钮	PA66	1	Yellow 黄色
1	Cover 盖板	Brass 黄铜	1	Ag plating 镀银
NO 序号	Part name 部件名	Material 材料	QTY 数量	Remark 备注

A4				
A3				
A2				
A1				
REV	DATE	REVISION	DESCRIPTION	ISSUE



COMMON TOLERANCE

X.XX	± 0.10
X.X	± 0.15
X	± 0.25

ANGULAR

UNIT	MM	PROJECTED		PRODUCT NAME:
DRAWN BY	FUYUAN	CHECKED BY	COCO	MODEL NO: TP10813550
DATE	2019	APPROVAL B	ALEN	Https: www.rocpcu.tw
ROCPCU TECHNOLOGY CO.,LTD				
Copies are issued in strict confidence and shall not be reproduced or copied, or used as the basic of manufacture or sale of apparatus without permission				