



CW78XX Series

3 TERMINAL 1.0A POSITIVE VOLTAGE REGULATORS

DESCRIPTION

The 78XX series of three-terminal positive regulators are available in TO-220 packages. Each type employs internal current limiting, thermal shut-down and safe area protection, making it essentially indestructible. If adequate heat sinking is provided, they can deliver over 1.0A output current. Although designed as fixed voltage regulators, these devices can be used with external components to obtain adjustable voltage and currents.

FEATURES

- *Output current up to 1.0A
- *Thermal overload protection
- *Short circuit protection
- *Output transistor SOA protection

1.IN
2.GND
3.OUT



1 2 3

TO-220

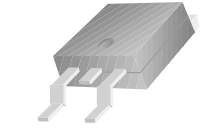

1 2 3

TO-252

BLOCK DIAGRAM

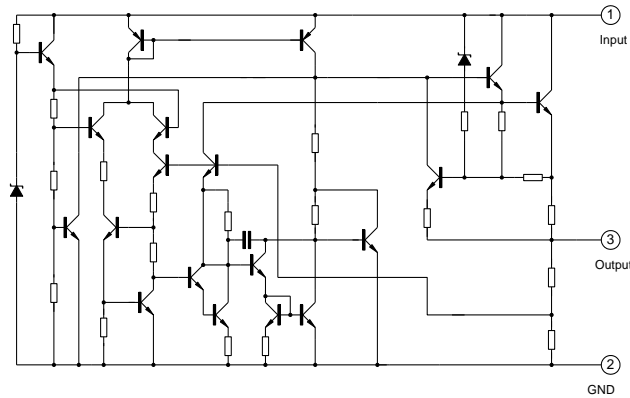



3 TERMINAL 1.0A POSITIVE VOLTAGE REGULATORS

ABSOLUTE MAXIMUM RATINGS (Ta = 25°C)

Characteristic	Symbol	Value	Unit
Input voltage	Vi	35	V
Thermal resistance junction-air	R(JA)	65	°C/W
Thermal resistance junction-cases	RθJC	5	°C/W
Operating Temperature	Topr	-20~+125	°C
Storage Temperature	Tstg	-65~+150	°C

7805 ELECTRICAL CHARACTERISTICS

(Refer to test circuits, 0<Tj<125°C, Io=500mA, Vi=10V, Ci=0.33μF, Co=0.1μF, unless otherwise specified)

Characteristic	Symbol	Test Conditions	Min	Typ	Max	Units
Output voltage	Vo	Tj=25°C	4.8	5.0	5.2	V
		5.0mA<Io<1.0A, Po<15W Vi=8V to 20V	4.75	5.00	5.25	V
Line regulation	ΔVo	Tj=25°C, Vi=7.5V to 20V		4	100	mV
		Tj=25°C, Vi=8V to 12V		2	50	mV
Load regulation	ΔVo	Tj=25°C, Io=5.0mA to 1.0A		9	100	mV
		Tj=25°C, Io=250mA to 750mA		4	50	mV
Quiescent current	Iq	Tj=25°C		4.2	8	mA
Quiescent current change	ΔIq	Io=5mA to 1.0A		0.03	0.5	mA
		Vi=8V to 25V, Io=500mA		0.3	0.8	mA
Output voltage drift	ΔVo/ΔT	Io=5mA		0.8		mV/°C
Output noise voltage	VN	f=10Hz to 100kHz, Ta=25°C		42		μV/Vo
Ripple rejection	RR	f=120Hz, Vi=8V to 18V	62	73		dB
Dropout voltage	Vo	Io=1.0A, Tj=25°C		2		V
Output resistance	Ro	f=1kHz		15		mΩ
Short circuit current	Isc	Vi=35V, Ta=25°C		200		mA

7806 ELECTRICAL CHARACTERISTICS

(Refer to test circuits, 0<Tj<125°C, Io=500mA, Vi=11V, Ci=0.33μF, Co=0.1μF, unless otherwise specified)

Characteristic	Symbol	Test Conditions	Min	Typ	Max	Units
Output voltage	Vo	Tj=25°C	5.75	6	6.25	V
		5.0mA<Io<1.0A, Po<15W Vi=9V to 21V	5.65	6	6.25	V
Line regulation	ΔVo	Tj=25°C, Vi=8.5V to 25V			120	mV
		Tj=25°C, Vi=9V to 13V			60	mV
Load regulation	ΔVo	Tj=25°C, Io=5.0mA to 1.0A			120	mV
		Tj=25°C, Io=250mA to 750mA			60	mV
Quiescent current	Iq	Tj=25°C		4.3	8	mA
Quiescent current change	ΔIq	Io=5mA to 1.0A			0.5	mA
		Vi=9V to 25V, Io=500mA			0.8	mA
Output voltage drift	ΔVo/ΔT	Io=5mA		0.8		mV/°C
Output noise voltage	VN	f=10Hz to 100kHz, Ta=25°C		42		μV/Vo
Ripple rejection	RR	f=120Hz, Vi=9V to 19V		68		dB
Dropout voltage	Vo	Io=1.0A, Tj=25°C		2		V
Output resistance	Ro	f=1kHz		17		mΩ
Short circuit current	Isc	Vi=35V, Ta=25°C		200		mA





3 TERMINAL 1.0A POSITIVE VOLTAGE REGULATORS

7808 ELECTRICAL CHARACTERISTICS

(Refer to test circuits, $0 < T_j < 125^\circ\text{C}$, $I_o = 500\text{mA}$, $V_i = 14\text{V}$, $C_i = 0.33\mu\text{F}$, $C_o = 0.1\mu\text{F}$, unless otherwise specified)

Characteristic	Symbol	Test Conditions	Min	Typ	Max	Units
Output voltage	V_o	$T_j = 25^\circ\text{C}$	7.84	8	8.16	V
		$5.0\text{mA} < I_o < 1.0\text{A}$, $P_o < 15\text{W}$ $V_i = 11.5\text{V}$ to 23V	7.7	8	8.3	V
Line regulation	ΔV_o	$T_j = 25^\circ\text{C}$, $V_i = 10.5\text{V}$ to 25V			160	mV
		$T_j = 25^\circ\text{C}$, $V_i = 11\text{V}$ to 17V			80	mV
Load regulation	ΔV_o	$T_j = 25^\circ\text{C}$, $I_o = 5.0\text{mA}$ to 1.0A			160	mV
		$T_j = 25^\circ\text{C}$, $I_o = 250\text{mA}$ to 750mA			80	mV
Quiescent current	I_q	$T_j = 25^\circ\text{C}$		4.3	8	mA
Quiescent current change	ΔI_q	$I_o = 5\text{mA}$ to 1.0A			0.5	mA
		$V_i = 11.5\text{V}$ to 25V , $I_o = 500\text{mA}$			0.8	mA
Output voltage drift	$\Delta V_o / \Delta T$	$I_o = 5\text{mA}$		1.0		mV/ $^\circ\text{C}$
Output noise voltage	V_N	$f = 10\text{Hz}$ to 100kHz , $T_a = 25^\circ\text{C}$		42		$\mu\text{V}/V_o$
Ripple rejection	RR	$f = 120\text{Hz}$, $V_i = 11.5\text{V}$ to 21.5V		62		dB
Dropout voltage	V_o	$I_o = 1.0\text{A}$, $T_j = 25^\circ\text{C}$		2		V
Output resistance	R_o	$f = 1\text{kHz}$		18		$\text{m}\Omega$
Short circuit current	Isc	$V_i = 35\text{V}$, $T_a = 25^\circ\text{C}$		200		mA

7809 ELECTRICAL CHARACTERISTICS

(Refer to test circuits, $0 < T_j < 125^\circ\text{C}$, $I_o = 500\text{mA}$, $V_i = 15\text{V}$, $C_i = 0.33\mu\text{F}$, $C_o = 0.1\mu\text{F}$, unless otherwise specified)

Characteristic	Symbol	Test Conditions	Min	Typ	Max	Units
Output voltage	V_o	$T_j = 25^\circ\text{C}$	8.82	9	9.18	V
		$5.0\text{mA} < I_o < 1.0\text{A}$, $P_o < 15\text{W}$ $V_i = 12.5\text{V}$ to 24V	8.65	9	9.35	V
Line regulation	ΔV_o	$T_j = 25^\circ\text{C}$, $V_i = 11.5\text{V}$ to 26V			180	mV
		$T_j = 25^\circ\text{C}$, $V_i = 12\text{V}$ to 18V			90	mV
Load regulation	ΔV_o	$T_j = 25^\circ\text{C}$, $I_o = 5.0\text{mA}$ to 1.0A			180	mV
		$T_j = 25^\circ\text{C}$, $I_o = 250\text{mA}$ to 750mA			90	mV
Quiescent current	I_q	$T_j = 25^\circ\text{C}$		4.3	8	mA
Quiescent current change	ΔI_q	$I_o = 5\text{mA}$ to 1.0A			0.5	mA
		$V_i = 12.5\text{V}$ to 25V , $I_o = 500\text{mA}$			0.8	mA
Output voltage drift	$\Delta V_o / \Delta T$	$I_o = 5\text{mA}$		1.2		mV/ $^\circ\text{C}$
Output noise voltage	V_N	$f = 10\text{Hz}$ to 100kHz , $T_a = 25^\circ\text{C}$		42		$\mu\text{V}/V_o$
Ripple rejection	RR	$f = 120\text{Hz}$, $V_i = 12.5\text{V}$ to 22.5V		61		dB
Dropout voltage	V_o	$I_o = 1.0\text{A}$, $T_j = 25^\circ\text{C}$		2		V
Output resistance	R_o	$f = 1\text{kHz}$		18		$\text{m}\Omega$
Short circuit current	Isc	$V_i = 35\text{V}$, $T_a = 25^\circ\text{C}$		200		mA

7810 ELECTRICAL CHARACTERISTICS

(Refer to test circuits, $0 < T_j < 125^\circ\text{C}$, $I_o = 500\text{mA}$, $V_i = 16\text{V}$, $C_i = 0.33\mu\text{F}$, $C_o = 0.1\mu\text{F}$, unless otherwise specified)

Characteristic	Symbol	Test Conditions	Min	Typ	Max	Units
Output voltage	V_o	$T_j = 25^\circ\text{C}$	9.7	10	10.3	V
		$5.0\text{mA} < I_o < 1.0\text{A}$, $P_o < 15\text{W}$ $V_i = 13.5\text{V}$ to 25V	9.6	10	10.4	V
Line regulation	ΔV_o	$T_j = 25^\circ\text{C}$, $V_i = 12.5\text{V}$ to 28V		8	200	mV
		$T_j = 25^\circ\text{C}$, $V_i = 14\text{V}$ to 20V		4	100	mV
Load regulation	ΔV_o	$T_j = 25^\circ\text{C}$, $I_o = 5.0\text{mA}$ to 1.0A		18	200	mV
		$T_j = 25^\circ\text{C}$, $I_o = 250\text{mA}$ to 750mA		8	100	mV
Quiescent current	I_q	$T_j = 25^\circ\text{C}$		4.3	8	mA
Quiescent current change	ΔI_q	$I_o = 5\text{mA}$ to 1.0A			0.5	mA
		$V_i = 13\text{V}$ to 28V , $I_o = 500\text{mA}$			0.8	mA
Output voltage drift	$\Delta V_o / \Delta T$	$I_o = 5\text{mA}$		1.3		mV/ $^\circ\text{C}$
Output noise voltage	V_N	$f = 10\text{Hz}$ to 100kHz , $T_a = 25^\circ\text{C}$		42		$\mu\text{V}/V_o$
Ripple rejection	RR	$f = 120\text{Hz}$, $V_i = 13\text{V}$ to 23V		61		dB
Dropout voltage	V_o	$I_o = 1.0\text{A}$, $T_j = 25^\circ\text{C}$		2		V
Output resistance	R_o	$f = 1\text{kHz}$		18		$\text{m}\Omega$
Short circuit current	Isc	$V_i = 35\text{V}$, $T_a = 25^\circ\text{C}$		200		mA





3 TERMINAL 1.0A POSITIVE VOLTAGE REGULATORS

7812 ELECTRICAL CHARACTERISTICS

(Refer to test circuits, $0 < T_j < 125^\circ\text{C}$, $I_o = 500\text{mA}$, $V_i = 19\text{V}$, $C_i = 0.33\mu\text{F}$, $C_o = 0.1\mu\text{F}$, unless otherwise specified)

Characteristic	Symbol	Test Conditions	Min	Typ	Max	Units
Output voltage	V_o	$T_j = 25^\circ\text{C}$	11.5	12	12.5	V
		$5.0\text{mA} < I_o < 1.0\text{A}$, $P_o < 15\text{W}$ $V_i = 15.5\text{V}$ to 27V	11.4	12	12.6	V
Line regulation	ΔV_o	$T_j = 25^\circ\text{C}$, $V_i = 14.5\text{V}$ to 30V			240	mV
		$T_j = 25^\circ\text{C}$, $V_i = 16\text{V}$ to 22V			120	mV
Load regulation	ΔV_o	$T_j = 25^\circ\text{C}$, $I_o = 5.0\text{mA}$ to 1.0A			240	mV
		$T_j = 25^\circ\text{C}$, $I_o = 250\text{mA}$ to 750mA			120	mV
Quiescent current	I_Q	$T_j = 25^\circ\text{C}$		4.4	8	mA
Quiescent current change	ΔI_Q	$I_o = 5\text{mA}$ to 1.0A			0.5	mA
		$V_i = 15\text{V}$ to 30V , $I_o = 500\text{mA}$			0.8	mA
Output voltage drift	$\Delta V_o / \Delta T$	$I_o = 5\text{mA}$		1.5		mV/ $^\circ\text{C}$
Output noise voltage	V_N	$f = 10\text{Hz}$ to 100kHz , $T_a = 25^\circ\text{C}$		42		$\mu\text{V}/V_o$
Ripple rejection	RR	$f = 120\text{Hz}$, $V_i = 15\text{V}$ to 25V		60		dB
Dropout voltage	V_o	$I_o = 1.0\text{A}$, $T_j = 25^\circ\text{C}$		2		V
Output resistance	R_o	$f = 1\text{kHz}$		18		$\text{m}\Omega$
Short circuit current	I_{sc}	$V_i = 35\text{V}$, $T_a = 25^\circ\text{C}$		200		mA

7815 ELECTRICAL CHARACTERISTICS

(Refer to test circuits, $0 < T_j < 125^\circ\text{C}$, $I_o = 500\text{mA}$, $V_i = 21\text{V}$, $C_i = 0.33\mu\text{F}$, $C_o = 0.1\mu\text{F}$, unless otherwise specified)

Characteristic	Symbol	Test Conditions	Min	Typ	Max	Units
Output voltage	V_o	$T_j = 25^\circ\text{C}$	14.4	15	15.6	V
		$5.0\text{mA} < I_o < 1.0\text{A}$, $P_o < 15\text{W}$ $V_i = 17.5\text{V}$ to 30V	14.25	15	15.75	V
Line regulation	ΔV_o	$T_j = 25^\circ\text{C}$, $V_i = 17.5\text{V}$ to 30V		15	300	mV
		$T_j = 25^\circ\text{C}$, $V_i = 20\text{V}$ to 26V		7	150	mV
Load regulation	ΔV_o	$T_j = 25^\circ\text{C}$, $I_o = 5.0\text{mA}$ to 1.0A		25	300	mV
		$T_j = 25^\circ\text{C}$, $I_o = 250\text{mA}$ to 750mA		10	150	mV
Quiescent current	I_Q	$T_j = 25^\circ\text{C}$		5	8	mA
Quiescent current change	ΔI_Q	$I_o = 5\text{mA}$ to 1.0A			0.5	mA
		$V_i = 18\text{V}$ to 30V , $I_o = 500\text{mA}$			0.8	mA
Output voltage drift	$\Delta V_o / \Delta T$	$I_o = 5\text{mA}$		1.8		mV/ $^\circ\text{C}$
Output noise voltage	V_N	$f = 10\text{Hz}$ to 100kHz , $T_a = 25^\circ\text{C}$		42		$\mu\text{V}/V_o$
Ripple rejection	RR	$f = 120\text{Hz}$, $V_i = 18\text{V}$ to 28V		60		dB
Dropout voltage	V_o	$I_o = 1.0\text{A}$, $T_j = 25^\circ\text{C}$		2		V
Output resistance	R_o	$f = 1\text{kHz}$		18		$\text{m}\Omega$
Short circuit current	I_{sc}	$V_i = 35\text{V}$, $T_a = 25^\circ\text{C}$		200		mA



TEST CIRCUITS

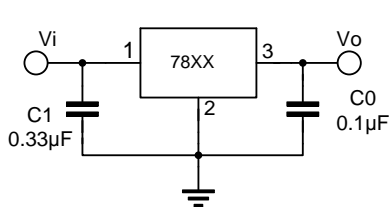

FIG.1 DC PARAMETERS

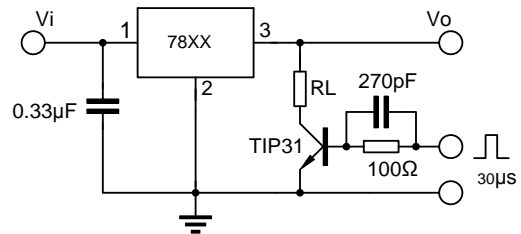

FIG.2 LOAD REGULATION

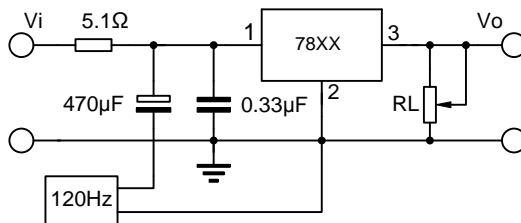

FIG.3 RIPPLE REJECTION



APPLICATION CIRCUITS

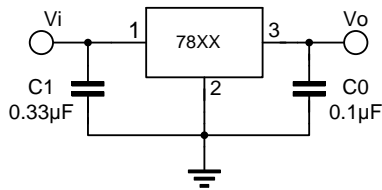

Fig.4 Fixed output regulator

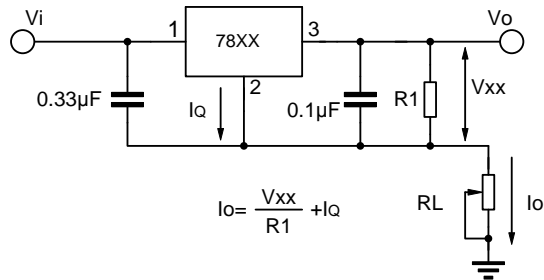

Fig.5 Constant current regulator

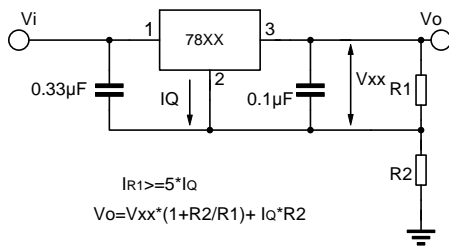

Fig.6 Circuit for increasing Regulator output voltage

$$I_{R1} \geq 5 \cdot I_Q$$

$$V_o = V_{xx} \cdot (1 + R_2/R_1) + I_Q \cdot R_2$$

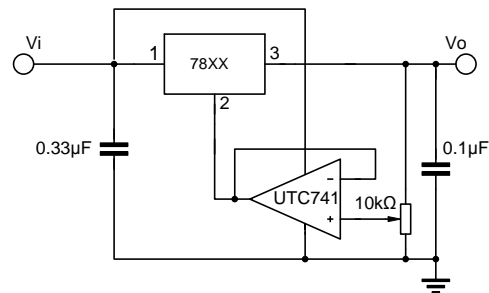

Fig.7 Adjustable output

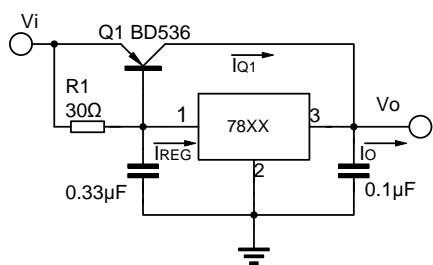

Fig.8 High current with voltage regulator

$$I_o = I_{REG} \cdot (I_{REG} - V_{BEQ1}/R_1)$$

$$R_1 = V_{BEQ1}/I_{REG} - I_Q \cdot R_1$$

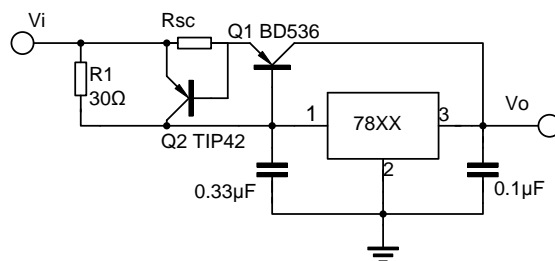

Fig.9 High output current short circuit protection

$$R_{sc} = V_{BEQ2}/I_{sc}$$





3 TERMINAL 1.0A POSITIVE VOLTAGE REGULATORS

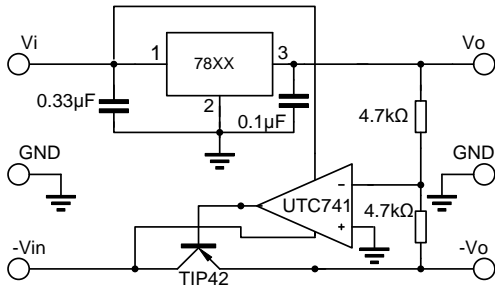

Fig.10 Tracking voltage regulator

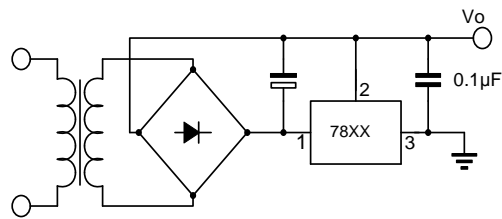

Fig.11 Negative output voltage circuit

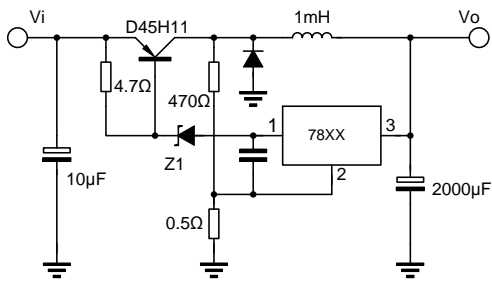

Fig.12 Switching regulator