

## WL2817DA

[Http://www.sh-willsemi.com](http://www.sh-willsemi.com)

### Ultra low dropout, 500mA/1A, CMOS LDO

#### Descriptions

The WL2817DA series are ultra low dropout, Low quiescent current, high PSRR CMOS LDO.

Using CMOS construction, the quiescent current consumed by the WL2817DA is typically 160uA over the entire input voltage range, making it attractive for consumer, networking applications that demand high output current. The WL2817DA series are available in wide output voltage range version from 1.0V to 3.3V.

The WL2817DA series offer thermal shutdown (OTP) and current limit functions, to assure the stability of chip and power system at wrong condition, and it uses trimming technique to guarantee output voltage accuracy within  $\pm 2\%$ .

The WL2817DA series can choose the output current limit between 1.0A or 500mA by alternating the LCON pin between "H" or "L". The WL2817DA regulators are available in DFN1612-8L packages. Standard products are Pb-free and Halogen-free.

#### Features

- Input voltage : 2.5V~5.5V
- Output voltage range : 1.0V 1.1V 1.2V 1.5V 1.8V 2.7V 2.8V 2.9V 3V 3.3V
- Output current : 500mA/1A
- PSRR : 60dB(@  $V_{OUT}=3V$ )
- Dropout voltage : 70mV @  $I_{OUT}=0.5A$
- Output noise : 50 $\mu$ V<sub>RMS</sub>
- Quiescent current : 160 $\mu$ A Typ.

#### Applications

- LCD TV
- STB
- Computer, Graphic card
- Network communication equipments
- Others portable electronics devices

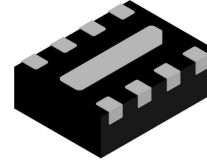

**DFN1612-8L**

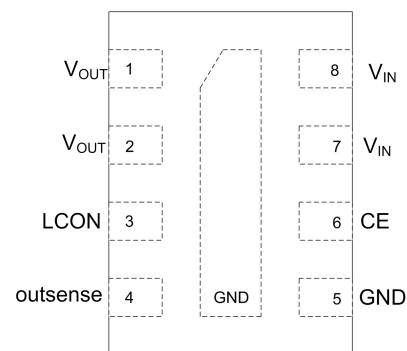

**Pin Configuration (Top View)**

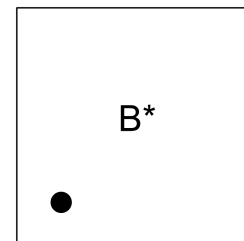

B = Device code (3.0V)  
 \* = Month code (N: 2015.01,  
 O:2015.02, and so on)

#### Marking

#### Order Information

For detail information, Please refer to page 15.

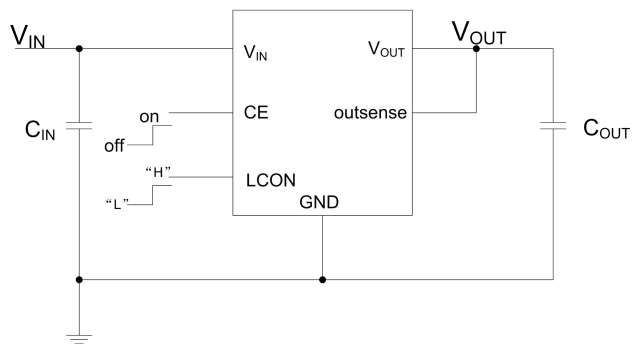
**Typical Application**

	Min.	Typ.	Max.
$C_{IN}$		4.7 $\mu$ F	
$C_{OUT}$		1 $\mu$ F	

**Pin Description**

PIN	Symbol	Description
1	$V_{OUT}$	Output
2	$V_{OUT}$	Output
3	LCON	Output Current Limit Alternate Pin ("H" =1A, "L" =500mA)
4	outsense	Feedback Pin
5	GND	Ground
6	CE	Enable, Active High
7	$V_{IN}$	Input
8	$V_{IN}$	Input

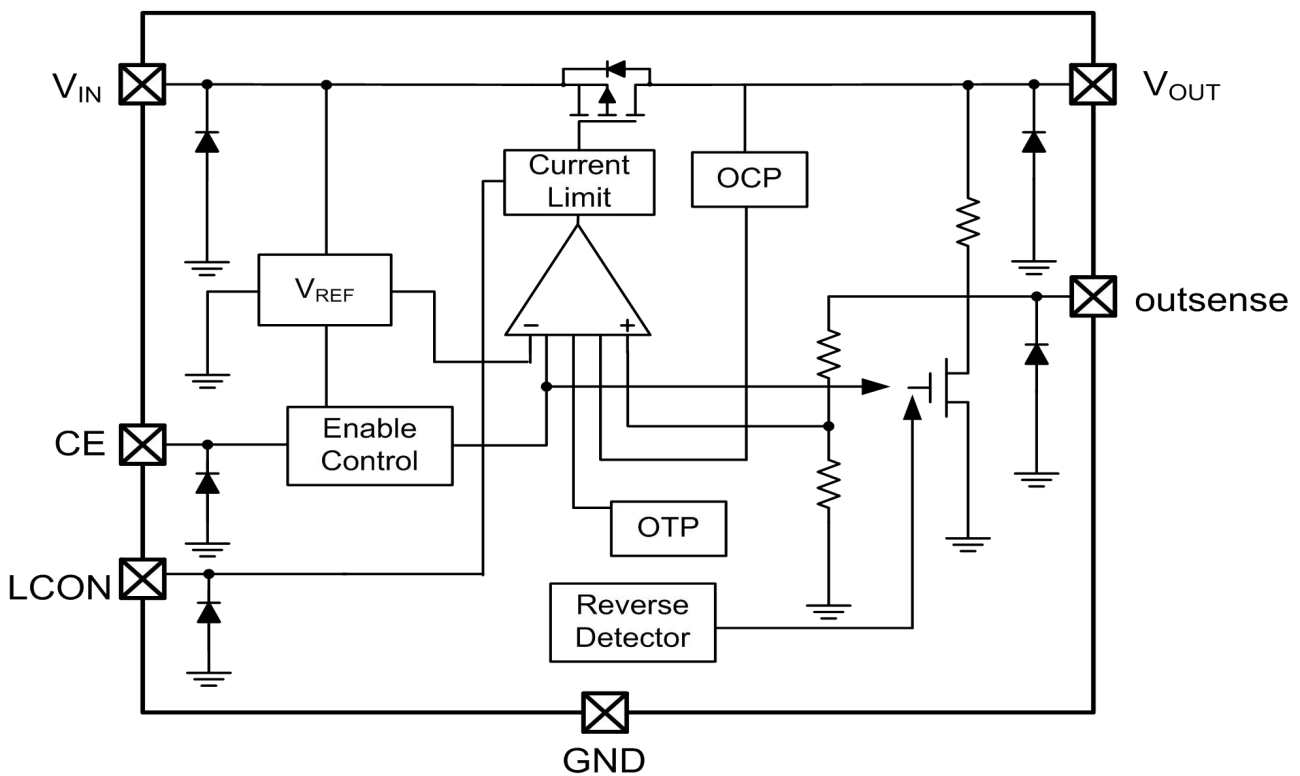
**Block Diagram**

**Absolute Maximum Ratings**

Parameter	Symbol	Value	Unit
Input voltage range	$V_{IN}$	-0.3~6.5	V
EN voltage range	$V_{EN}$	-0.3~ $V_{IN}$	V
LCON voltage range	$V_{LCON}$	-0.3~ $V_{IN}$	V
Output voltage range	$V_{OUT}$	-0.3~ $V_{IN}$	V
Power dissipation *1	$P_D$	625	mW
Thermal resistance	$R_{\theta JA}$	165	°C/W
Junction temperature	$T_J$	150	°C
Lead temperature(10s)	$T_L$	260	°C
Storage temperature	$T_{stg}$	-55 ~ 150	°C
ESD Ratings	HBM	2000	V
	MM	200	V

**Note:** These are stress ratings only. Stresses exceeding the range specified under “Absolute Maximum Ratings” may cause substantial damage to the device. Functional operation of this device at other conditions beyond those listed in the specification is not implied and prolonged exposure to extreme conditions may affect device reliability.

\*1: Power dissipation is calculate by  $P_D = (V_{IN} - V_{OUT}) \times I_{OUT}$

**Recommend Operating Ratings**

Parameter	Symbol	Value	Unit
Operating Supply voltage	$V_{IN}$	2.5~5.5	V
Operating Temperature Range	$T_{opr}$	-40~85	°C

**Electronics Characteristics (Ta=25°C, VIN=VOUT+1V, CIN=4.7uF, COUT=1uF, IOUT=1mA, LCON=EN=VIN, unless otherwise noted)**

Parameter	Symb ol	Condition		Min.	Typ.	Max.	Unit
Output Voltage	V <sub>OUT</sub>	T=25°C		V <sub>oset</sub> *0.98	V <sub>oset</sub>	V <sub>oset</sub> *1.02	V
		-40°C≤T≤85°C		V <sub>oset</sub> *0.97	V <sub>oset</sub>	V <sub>oset</sub> *1.03	
Current Limit	I <sub>LIM</sub>	V <sub>IN</sub> =V <sub>set</sub> +0.5V	LCON= "H"	1			A
			LCON= "L"	0.5			A
Dropout Voltage	V <sub>DROP</sub>	V <sub>OUT</sub> =V <sub>OUT</sub> *0.97	I <sub>OUT</sub> =0.5A		70		mV
Load Regulation	ΔV <sub>Load</sub>	V <sub>IN</sub> =V <sub>set</sub> +0.5V	LCON= "H" : 1mA≤I <sub>OUT</sub> ≤1A		3.5		mV
			LCON= "L" : 1mA≤I <sub>OUT</sub> ≤0.5A		1.5		mV
UVLO	V <sub>uvlo</sub>				2		V
Line Regulation	ΔV <sub>LINE</sub>	V <sub>set</sub> +0.5V≤V <sub>IN</sub> ≤5.5V (V <sub>IN</sub> ≥UVLO)			5	10	mV
Quiescent Current	I <sub>Q</sub>	I <sub>OUT</sub> =0			160	220	uA
Shut-down Current	I <sub>SHDN</sub>	V <sub>EN</sub> = 0V			1	3	uA
V <sub>OUT</sub> Temperature Coefficient	ΔV <sub>OUT</sub> /ΔT	-40°C≤T≤85°C			100		ppm/°C
Short Current Limit	I <sub>sc</sub>	V <sub>OUT</sub> =0V	LCON= "H"		160		mA
			LCON= "L"		80		mA
Inrush Current Limit	I <sub>rush</sub> <sup>*1</sup>	CC mode	LCON= "H"		500		mA
			LCON= "L"		250		mA
Reverse Current	I <sub>rev</sub> <sup>*2</sup>	V <sub>OUT</sub> =V <sub>oset</sub> +1V; EN=0; 0≤V <sub>IN</sub> ≤V <sub>rev_del</sub>			4.5	10	uA
Detector offset voltage in reverse current protection mode	V <sub>rev_det</sub> <sup>*3</sup>	V <sub>OUT</sub> =V <sub>oset</sub> +1V; EN=0			0.5		V
Release offset voltage in reverse current protection mode	V <sub>rev_rel</sub> <sup>*4</sup>	V <sub>OUT</sub> =V <sub>oset</sub> +1V; EN=0			0.35		V
Max reverse Current	I <sub>revmax</sub> <sup>*5</sup>	V <sub>OUT</sub> =V <sub>oset</sub> +1V; EN=0			70		uA
Discharge resistance	R <sub>dis</sub>	EN=0			60		Ω
Power Supply Ripple Rejection	PSRR	V <sub>IN</sub> =(V <sub>OUT</sub> +1V) <sub>DC</sub> +0.2V <sub>P-P</sub> F=1KHz, I <sub>OUT</sub> =10mA			60		dB
Output noise voltage (V <sub>OUT</sub> =3V)	e <sub>NO</sub>	BW=10Hz to 100KHz I <sub>OUT</sub> =0			40		μV <sub>RMS</sub>
		BW=10Hz to 100KHz I <sub>OUT</sub> =10mA			60		
Output noise voltage (V <sub>OUT</sub> =1.0V)	e <sub>NO</sub>	BW=10Hz to 100KHz I <sub>OUT</sub> =0			20		μV <sub>RMS</sub>
		BW=10Hz to 100KHz I <sub>OUT</sub> =10mA			35		
EN logic high voltage	V <sub>ENH</sub>	V <sub>IN</sub> =5.5V, I <sub>OUT</sub> =1mA		1.2			V

EN logic low voltage	$V_{ENL}$	$V_{IN}=5.5V, I_{OUT}=0mA$			0.4	V
EN pull-down current	$I_{en}$			0.2	1	$\mu A$
LCON pull-down current	$I_{LCON}$			0.2	1	$\mu A$
EN logic high voltage	$V_{ENH}$		1.2			V
EN logic low voltage	$V_{ENL}$				0.4	V
LCON logic high voltage	$V_{ENH}$		1.2			V
LCON logic low voltage	$V_{ENL}$				0.4	V
Thermal shutdown threshold	$T_{SD}$			165		$^{\circ}C$
Thermal shutdown hysteresis	$\Delta T_{SD}$			30		$^{\circ}C$

\*1: For CC (Constant Current) mode, please refer to Start-up Characteristics.

\*2 \*3 \*4 \*5: Please refer to reverse current protection mode

## Start-up Characteristics

Constant slope circuit is included in the WL2817DA to prevent the overshoot of the output voltage. If inrush current increases due to the large capacitance of  $C_{OUT}$ , the operation mode will be shift from Constant Slope (CS) mode to Constant Current (CC) mode. The CC mode maintains a constant inrush current. In the CC mode,  $t_{on}$  varies with the size of  $C_{OUT}$  and the load current.

## Reverse Current Protection Circuit

The WL2817DA include a Reverse Current Protection Circuit, which stop the reverse current from  $V_{OUT}$  pin to  $V_{IN}$  pin or GND pin when  $V_{OUT}$  becomes higher than  $V_{IN}$ .

Following figure shows the load characteristics of each mode. When giving the  $V_{OUT}$  pin a constant voltage and decreasing the  $V_{IN}$  voltage, the  $V_{IN}$  voltage will become lower than  $V_{OUT}-V_{rev\_det}$ , the reverse current protection starts to function to stop the load current. By increasing the  $V_{IN}$  voltage higher than  $V_{OUT}-V_{rev\_rel}$ , the protection mode will be released to let the load current to flow. When  $V_{IN}$  voltage is between  $V_{OUT}$  and  $V_{rev\_det}$ , the parasitic diode between  $V_{IN}$  pin and  $V_{OUT}$  pin becomes forward direction. As a result, the current flows from  $V_{OUT}$  pin to  $V_{IN}$  pin, and the maximum of the current is  $I_{revmax}$ .

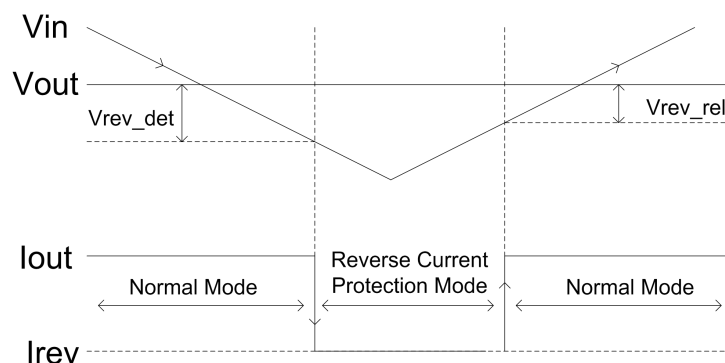
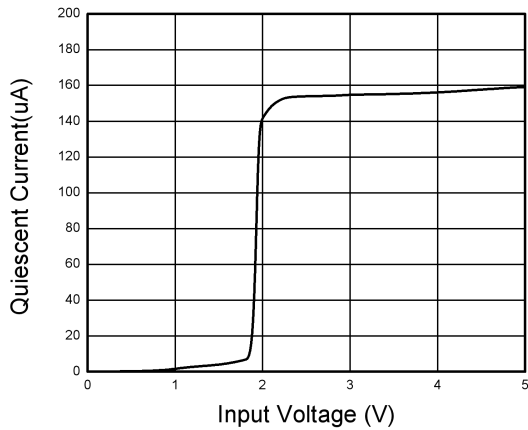
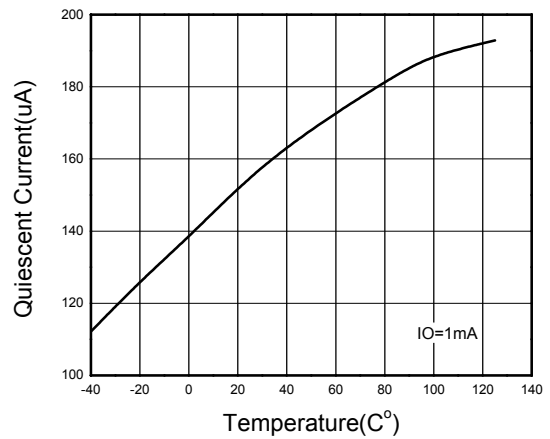

Figure1.Detection/Release Threshold value of Reverse Current Protection

Typical characteristics ( $T_a=25^{\circ}\text{C}$ ,  $V_{\text{IN}}=4\text{V}$ ,  $V_{\text{OUT}}=3\text{V}$ ,  $C_{\text{IN}}=4.7\mu\text{F}$ ,  $C_{\text{OUT}}=1\mu\text{F}$ , unless otherwise noted)



Quiescent current vs. Input voltage



Quiescent current vs. Temperature

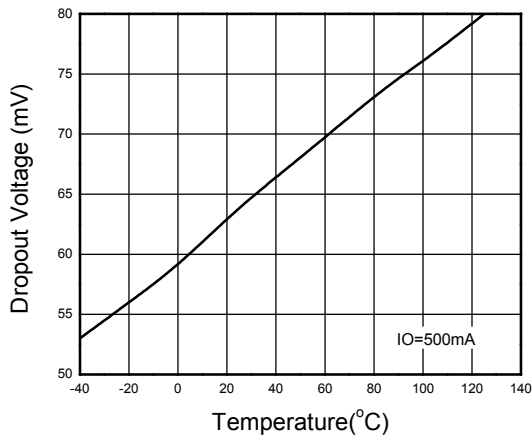

Dropout Voltage vs. Temperature

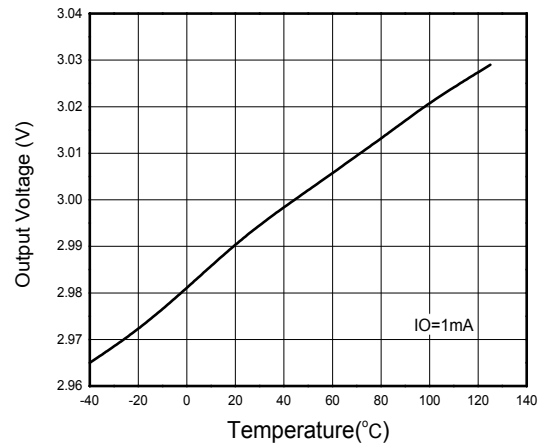

Output Voltage vs. Temperature

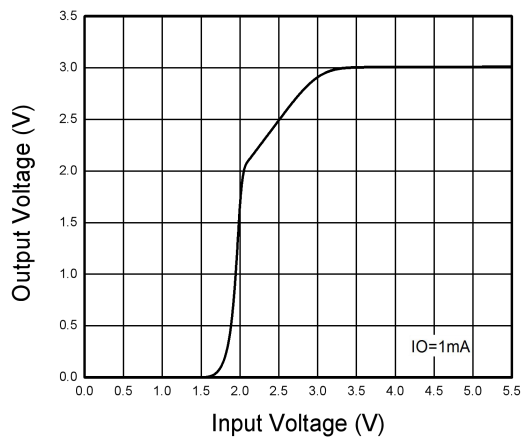

Output voltage vs. Input voltage

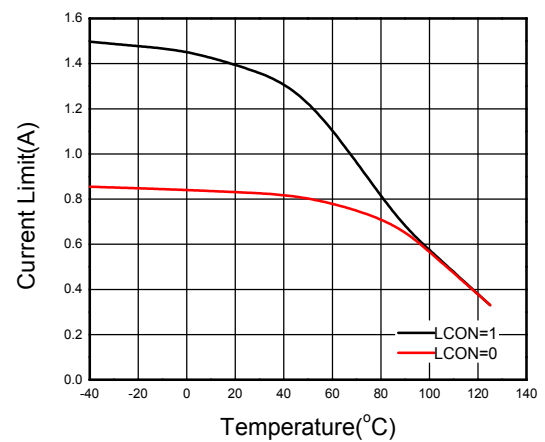

Current Limit vs. Temperature

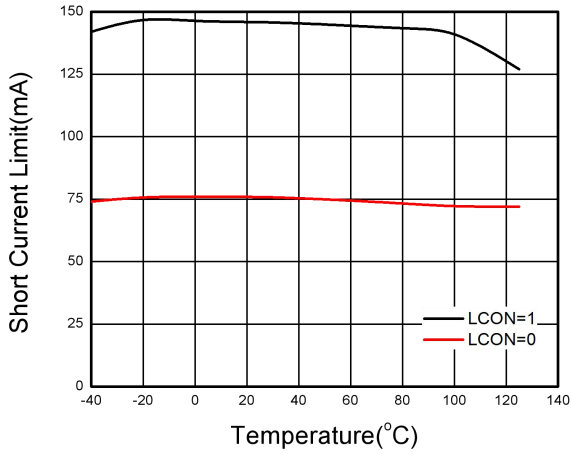
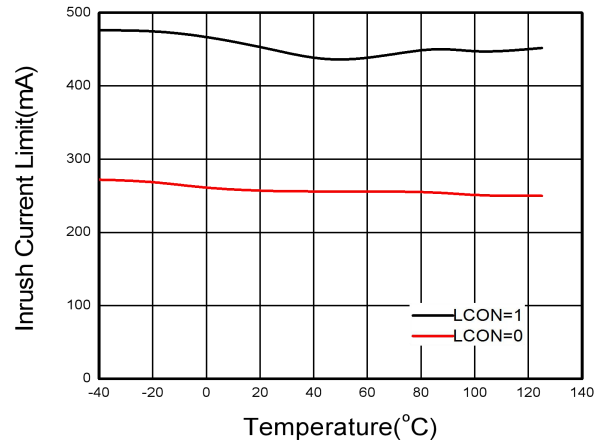
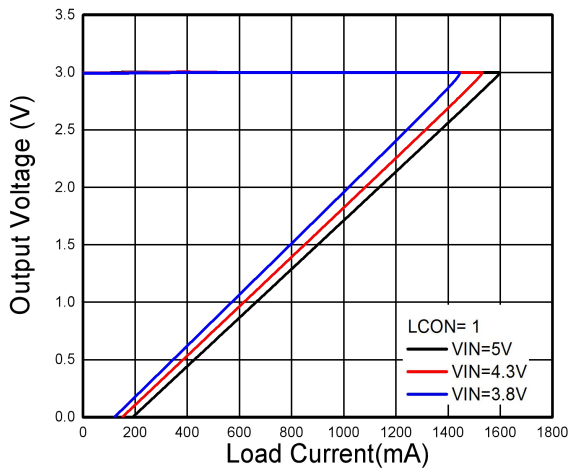
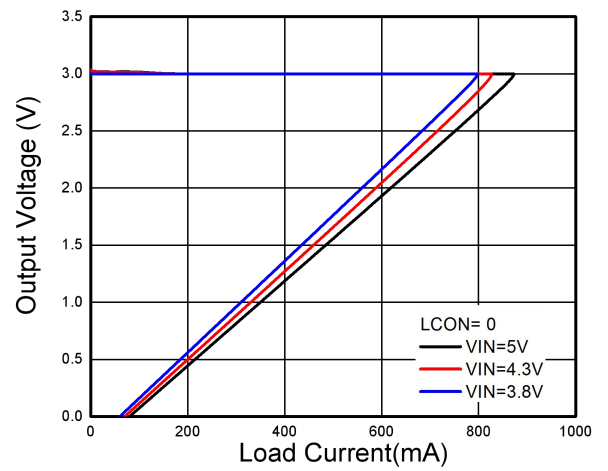

**Short Current Limit vs. Temperature**

**Inrush Current Limit vs. Temperature**

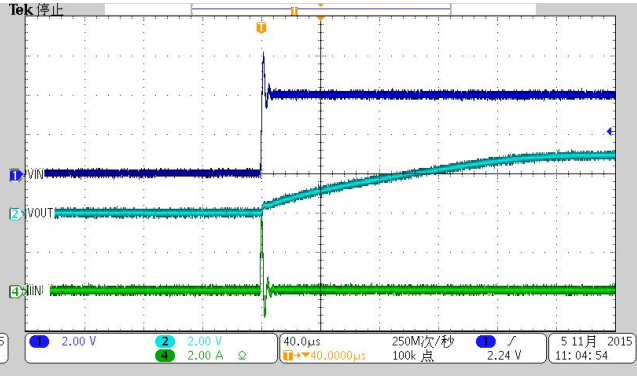
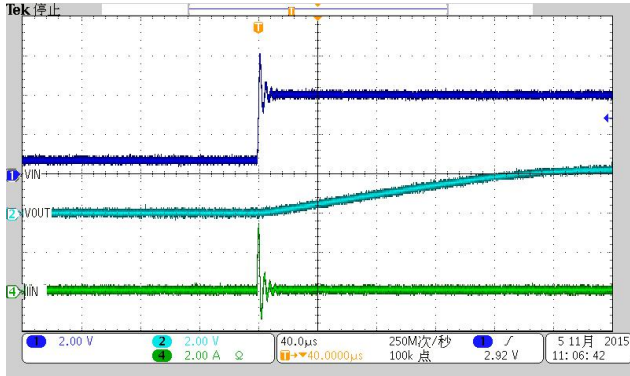
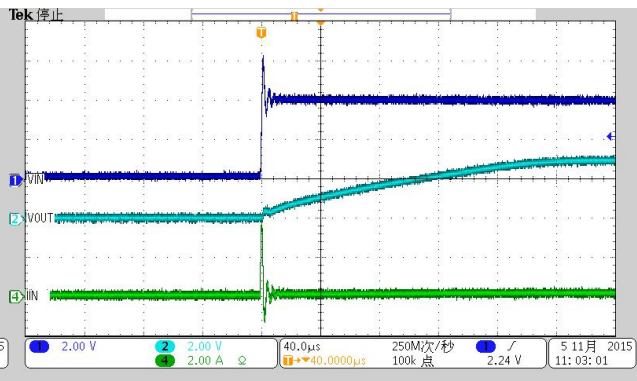
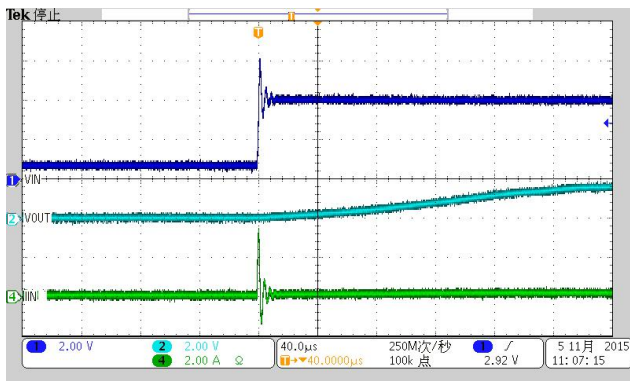
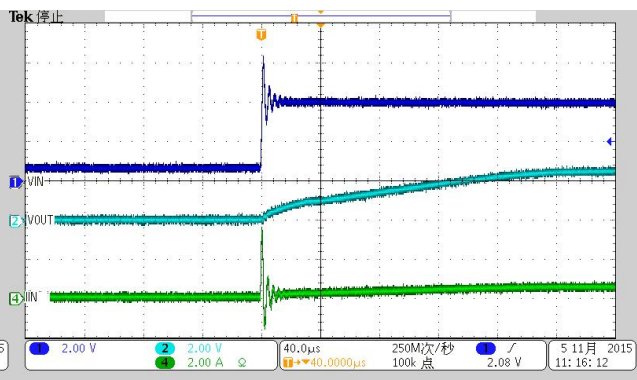
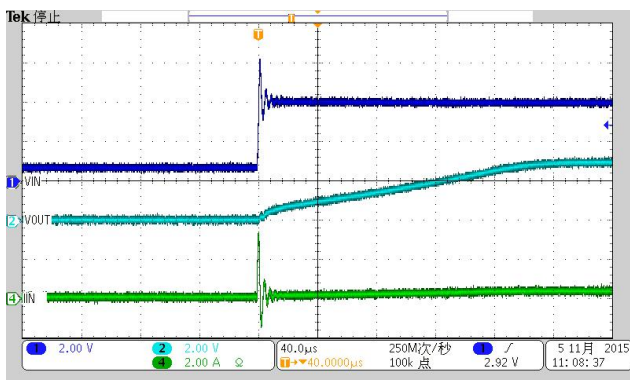
**Output Voltage vs. Load Current**

**Output Voltage vs. Load Current**

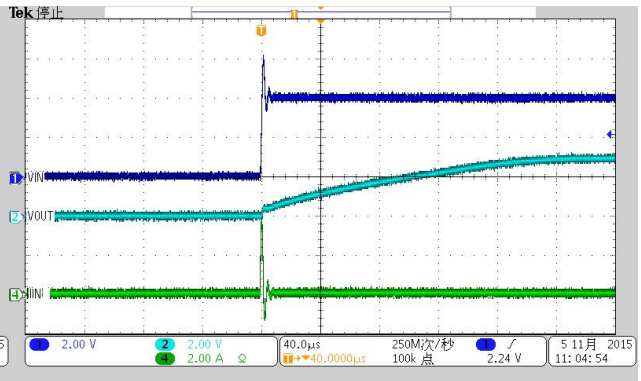
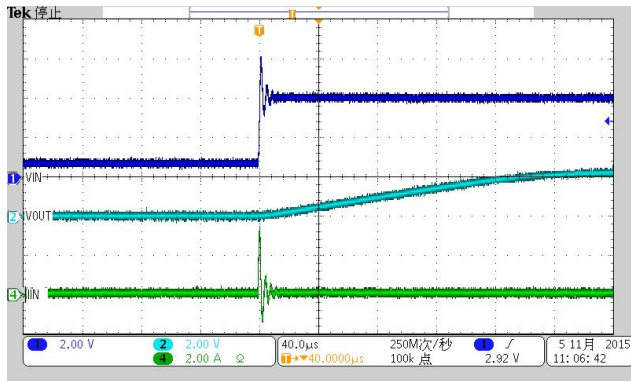
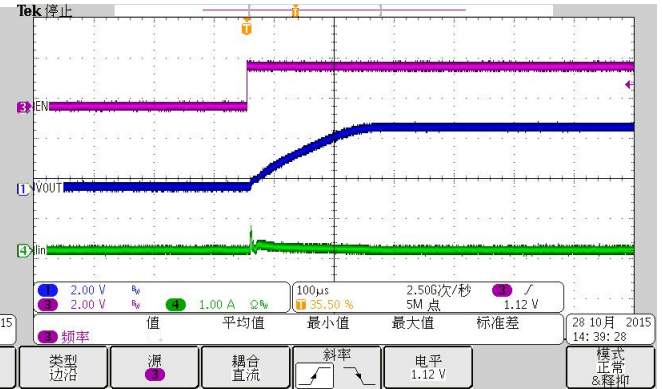
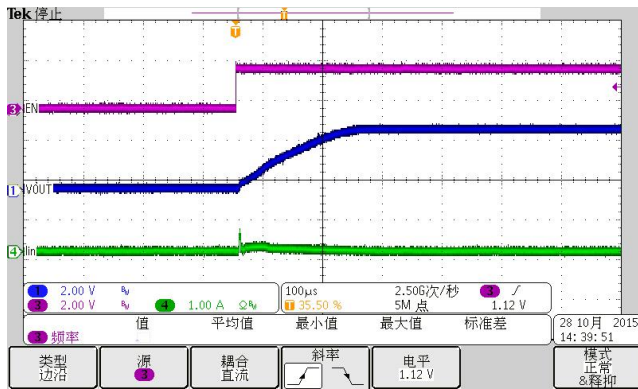
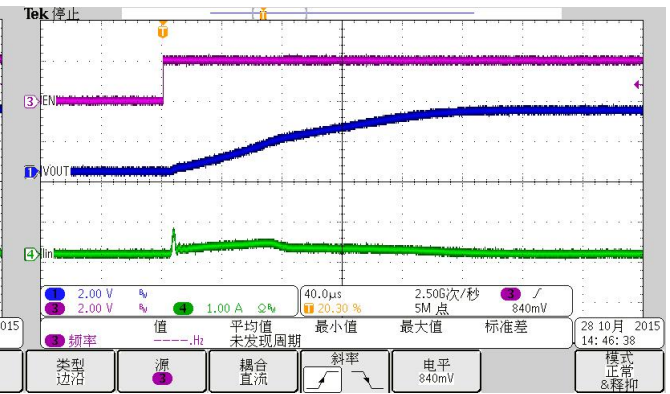
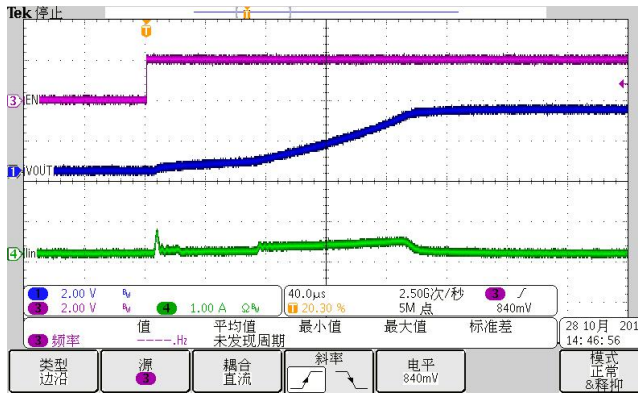
# 1.Start up

## A: Different Load

**LCON=0**
**LCON=1**
 $V_{IN}=4V, I_{OUT}=0mA$ 
 $V_{IN}=4V, I_{OUT}=0mA$ 

 $V_{IN}=4V, I_{OUT}=100mA$ 
 $V_{IN}=4V, I_{OUT}=100mA$ 

 $V_{IN}=4V, I_{OUT}=300mA$ 
 $V_{IN}=4V, I_{OUT}=600mA$ 

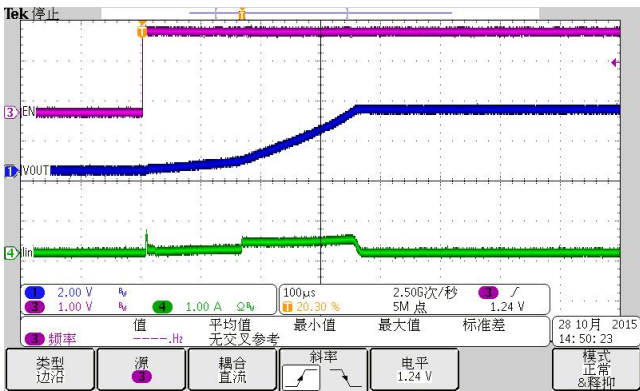
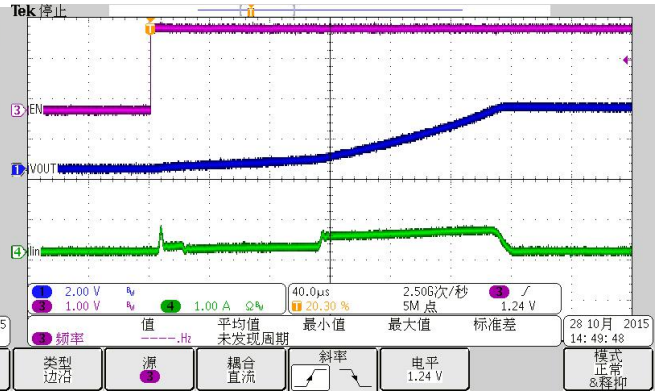
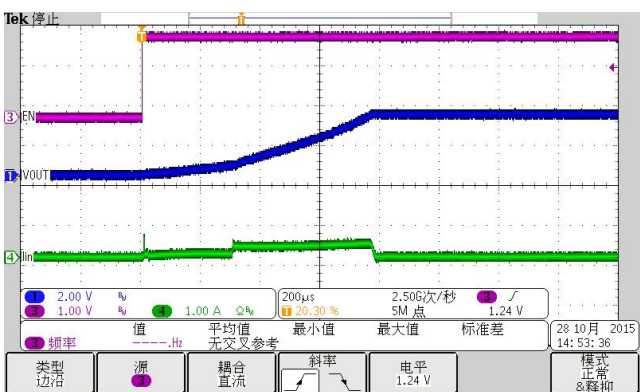
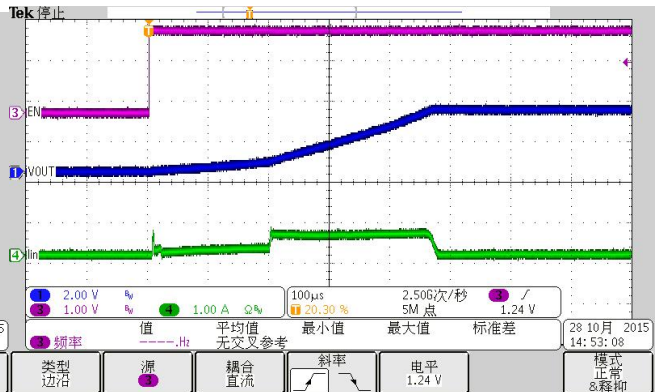
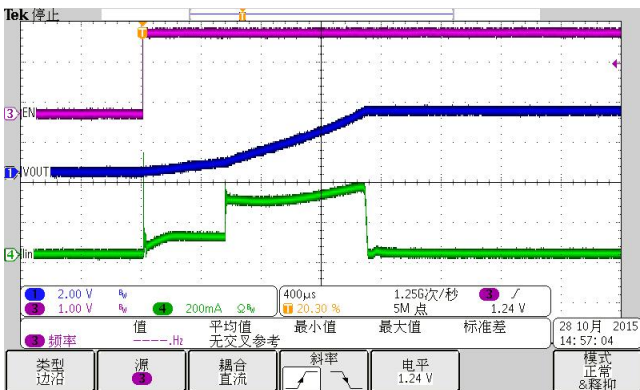
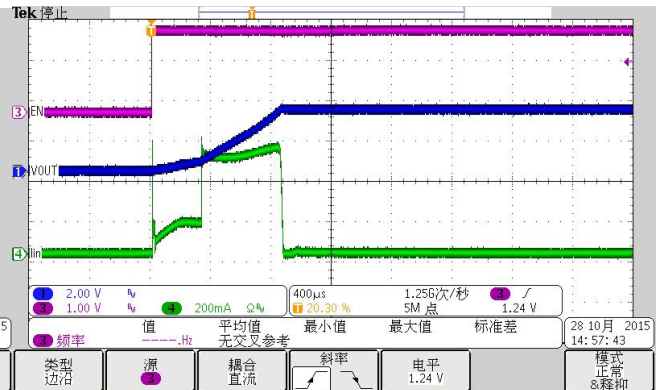

**B: Different Cout**
**LCON=0**
**LCON=1**
 $V_{IN}=4V, C_{OUT}=1\mu F$ 
 $V_{IN}=4V, C_{OUT}=1\mu F$ 

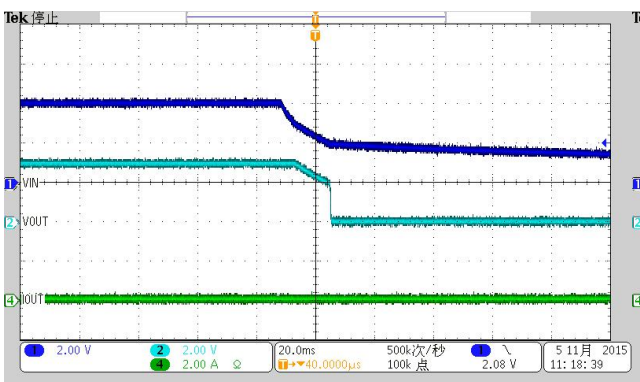
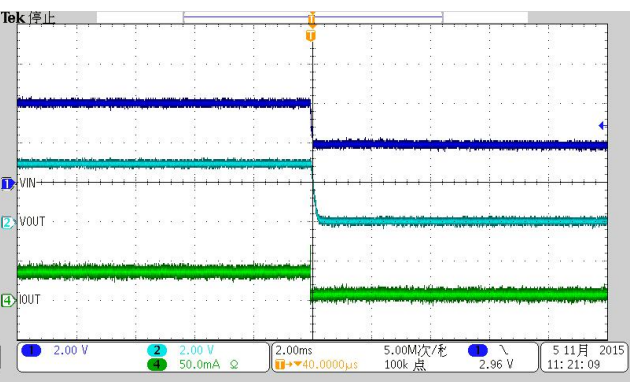
 $V_{IN}=4V, C_{OUT}=4.7\mu F$ 
 $V_{IN}=4V, C_{OUT}=4.7\mu F$ 

 $V_{IN}=4V, C_{OUT}=10\mu F$ 
 $V_{IN}=4V, C_{OUT}=10\mu F$ 

$V_{IN}=4V, C_{OUT}=22\mu F$ 

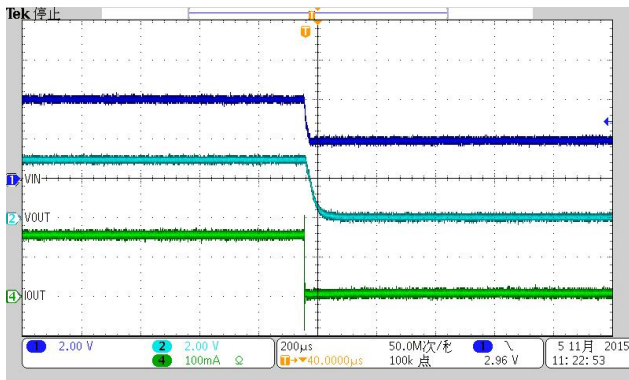
 $V_{IN}=4V, C_{OUT}=22\mu F$ 

 $V_{IN}=4V, C_{OUT}=47\mu F$ 

 $V_{IN}=4V, C_{OUT}=47\mu F$ 

 $V_{IN}=4V, C_{OUT}=100\mu F$ 

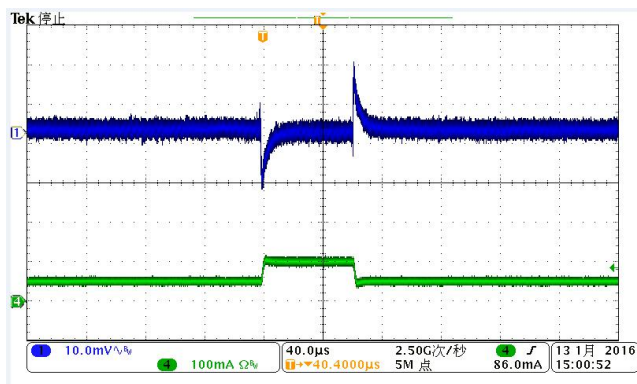
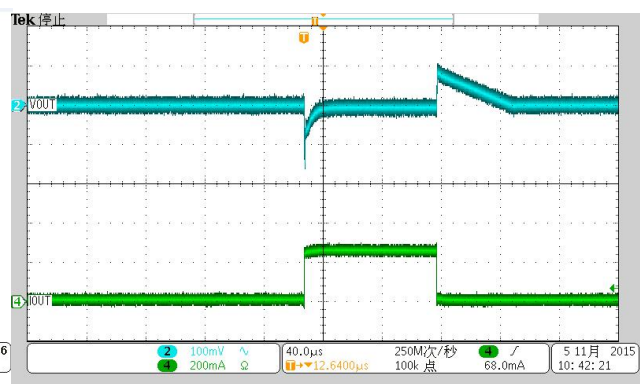
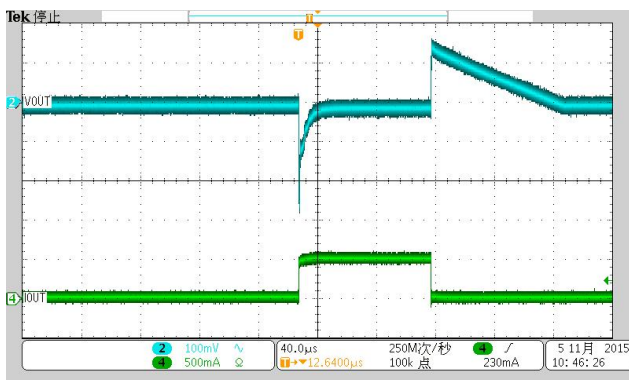
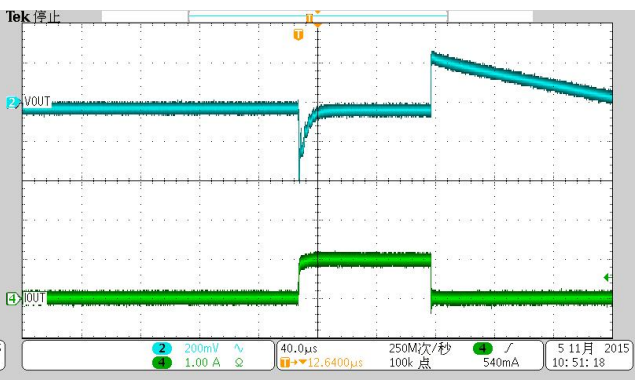
 $V_{IN}=4V, C_{OUT}=100\mu F$ 

## 2. Shut down

 $V_{IN}=4V, I_{OUT}=0mA$ 

 $V_{IN}=4V, I_{OUT}=30mA$ 

$V_{IN}=4V, I_{OUT}=150mA$ 

### 3. Load Step

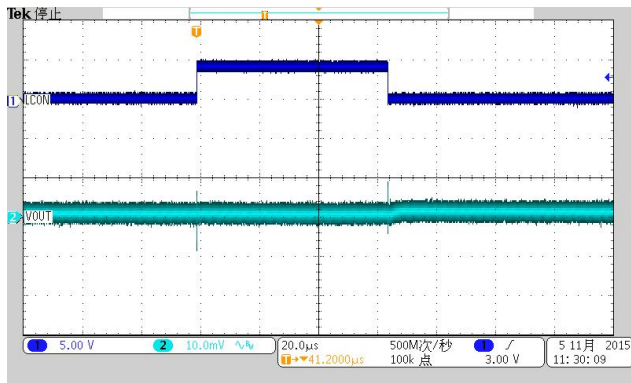
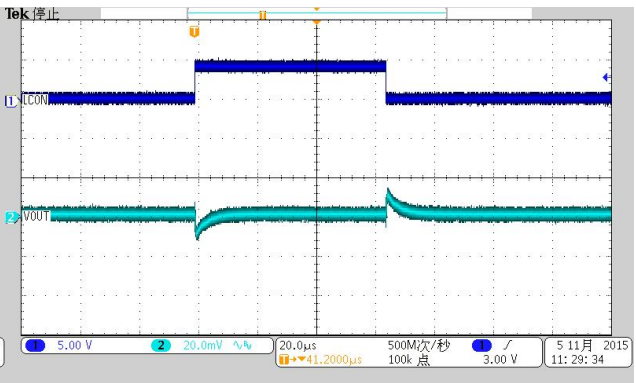
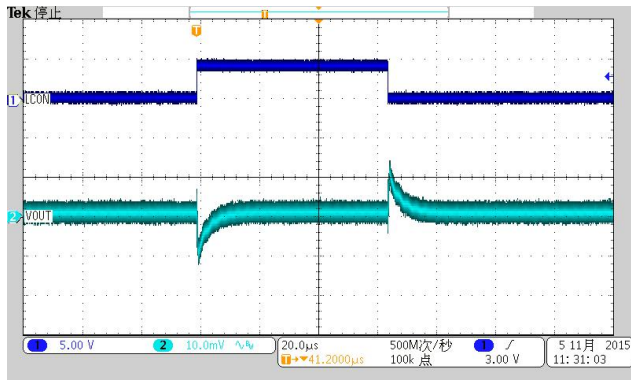
 $V_{IN}=4V, I_{OUT}=50mA-100mA$ 

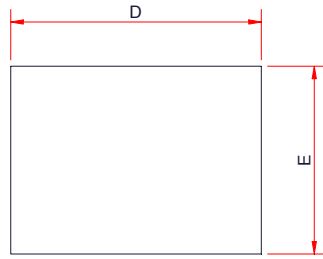
 $V_{IN}=4V, I_{OUT}=1mA-250mA$ 

 $V_{IN}=4V, I_{OUT}=1mA-500mA$ 

 $V_{IN}=4V, I_{OUT}=1mA-1A$ 

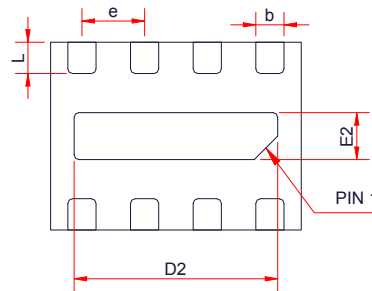
**4.LCON Line Step**
 $V_{IN}=4V, I_{OUT}=0mA$ 

 $V_{IN}=4V, I_{OUT}=150mA$ 

 $V_{IN}=4V, I_{OUT}=500mA$ 

**PACKAGE OUTLINE DIMENSIONS**
**DFN1612-8L**

TOP VIEW

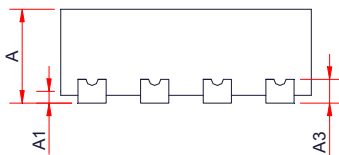

BOTTOM VIEW



SIDE VIEW

Symbol	Dimensions in Millimeters		
	Min.	Typ.	Max.
A	0.50	0.55	0.60
A1	-	-	0.05
A3	0.15 Ref.		
D	1.55	1.60	1.65
E	1.15	1.20	1.25
D2	1.25	1.30	1.35
E2	0.25	0.30	0.35
b	0.13	0.18	0.23
e	0.40 BSC		
L	0.15	0.20	0.25

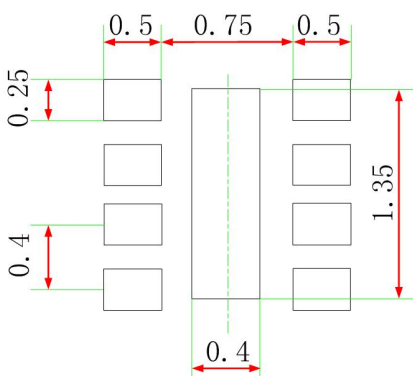
**Recommend PCB Layout (Unit: mm)**

**Notes:**

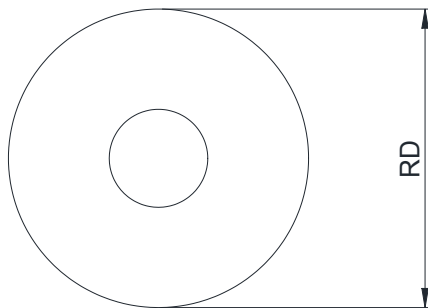
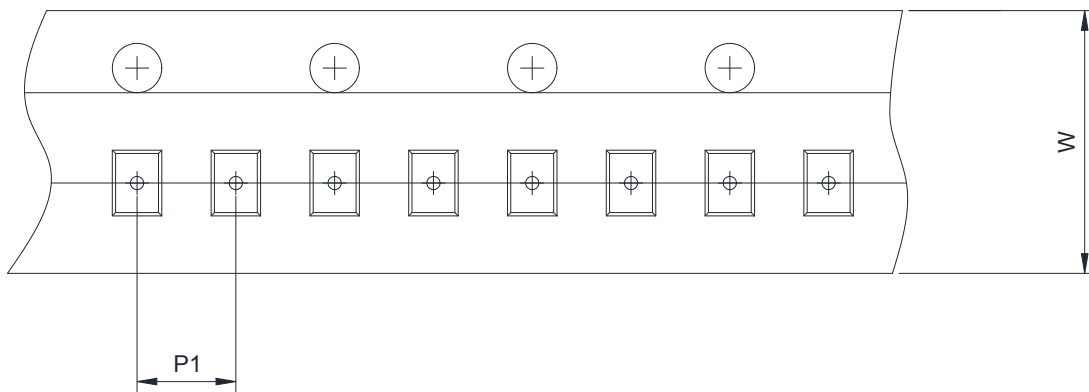
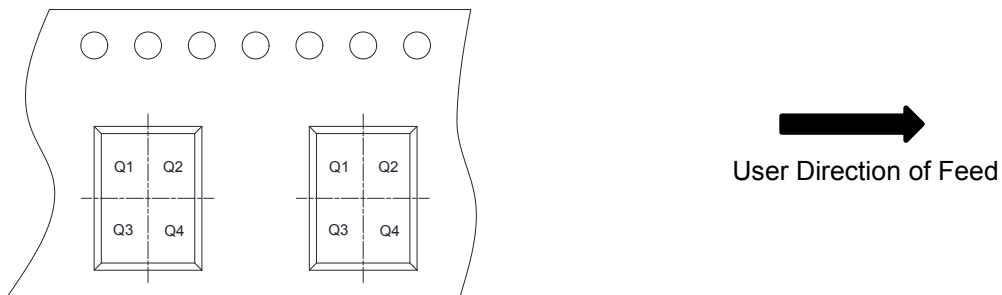
This recommended land pattern is for reference purposes only. Please consult your manufacturing group to ensure your PCB design guidelines are met.

**TAPE AND REEL INFORMATION**
**Reel Dimensions**

**Tape Dimensions**

**Quadrant Assignments For PIN1 Orientation In Tape**

RD	Reel Dimension	<input checked="" type="checkbox"/> 7inch	<input type="checkbox"/> 13inch
W	Overall width of the carrier tape	<input checked="" type="checkbox"/> 8mm	<input type="checkbox"/> 12mm <input type="checkbox"/> 16mm
P1	Pitch between successive cavity centers	<input type="checkbox"/> 2mm	<input checked="" type="checkbox"/> 4mm <input type="checkbox"/> 8mm
Pin1	Pin1 Quadrant	<input checked="" type="checkbox"/> Q1	<input type="checkbox"/> Q2 <input type="checkbox"/> Q3 <input type="checkbox"/> Q4

**ORDER INFORMATION**

Ordering No.	V <sub>OUT</sub> (V)	Package	Marking	Operating Temperature	Shipping
WL2817DA10-8/TR	1.0	DFN1612-8L	C*	-40 ~ +85°C	3000/Tape and Reel
WL2817DA11-8/TR	1.1	DFN1612-8L	J*	-40 ~ +85°C	3000/Tape and Reel
WL2817DA12-8/TR	1.2	DFN1612-8L	K*	-40 ~ +85°C	3000/Tape and Reel
WL2817DA15-8/TR	1.5	DFN1612-8L	L*	-40 ~ +85°C	3000/Tape and Reel
WL2817DA18-8/TR	1.8	DFN1612-8L	D*	-40 ~ +85°C	3000/Tape and Reel
WL2817DA27-8/TR	2.7	DFN1612-8L	M*	-40 ~ +85°C	3000/Tape and Reel
WL2817DA28-8/TR	2.8	DFN1612-8L	E*	-40 ~ +85°C	3000/Tape and Reel
WL2817DA29-8/TR	2.9	DFN1612-8L	N*	-40 ~ +85°C	3000/Tape and Reel
WL2817DA30-8/TR	3.0	DFN1612-8L	B*	-40 ~ +85°C	3000/Tape and Reel
WL2817DA33-8/TR	3.3	DFN1612-8L	I*	-40 ~ +85°C	3000/Tape and Reel