

N-Channel Trench Power MOSFET

General Description

The RS30N100D uses advanced trench technology to provide excellent $R_{DS(ON)}$, low gate charge and operation with gate voltages as low as 5V. This device is suitable for use as a wide variety of applications.

Features

- $V_{DS} = 30V, I_D = 100A$
 $R_{DS(ON)} < 4m\Omega @ V_{GS} = 10V$
 $R_{DS(ON)} < 7m\Omega @ V_{GS} = 5V$
- High Power and current handing capability
- Lead free product is acquired
- Surface Mount Package

Application

- PWM applications
- Load switch
- Power management

100% UIS TESTED!
100% ΔV_{ds} TESTED!

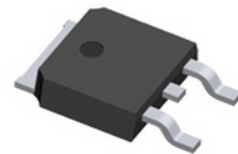
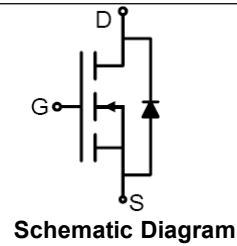

TO-252(DPAK) top view

Package Marking and Ordering Information

Device Marking	Device	Device Package	Reel Size	Tape width	Quantity
RS30N100D	RS30N100D	TO-252	325mm	16mm	2500

Table 1. Absolute Maximum Ratings ($T_A=25^\circ C$)

Symbol	Parameter	Value	Unit
V_{DS}	Drain-Source Voltage ($V_{GS}=0V$)	30	V
V_{GS}	Gate-Source Voltage ($V_{DS}=0V$)	± 20	V
I_D	Drain Current-Continuous($T_c=25^\circ C$)	100	A
	Drain Current-Continuous($T_c=100^\circ C$)	70	A
$I_{DM (pluse)}$	Drain Current-Continuous@ Current-Pulsed (Note 1)	400	A
P_D	Maximum Power Dissipation($T_c=25^\circ C$)	88	W
	Maximum Power Dissipation($T_c=100^\circ C$)	44	W
E_{AS}	Avalanche energy (Note 2)	320	mJ
T_J, T_{STG}	Operating Junction and Storage Temperature Range	-55 To 175	$^\circ C$

Notes 1.Repetitive Rating: Pulse width limited by maximum junction temperature

Notes 2.EAS condition: $T_J=25^\circ C, V_{DD}=20V, V_G=10V, R_G=25\Omega$

Table 2. Thermal Characteristic

Symbol	Parameter	Typ	Max	Unit
$R_{\theta JC}$	Thermal Resistance, Junction-to-Case	-	1.7	$^\circ C/W$

Table 3. Electrical Characteristics (TA=25°C unless otherwise noted)

Symbol	Parameter	Conditions	Min	Typ	Max	Unit
On/Off States						
B _{VDS}	Drain-Source Breakdown Voltage	V _{GS} =0V, I _D =250μA	30			V
I _{DSS}	Zero Gate Voltage Drain Current	V _{DS} =30V, V _{GS} =0V			1	μA
I _{GSS}	Gate-Body Leakage Current	V _{GS} =±20V, V _{DS} =0V			±100	nA
V _{GS(th)}	Gate Threshold Voltage	V _{DS} =V _{GS} , I _D =250μA	1	1.5	2.5	V
g _{FS}	Forward Transconductance	V _{DS} =5V, I _D =15A		30		S
R _{DS(ON)}	Drain-Source On-State Resistance	V _{GS} =10V, I _D =20A		3.1	4	mΩ
		V _{GS} =5V, I _D =15A		4.2	7	mΩ
Dynamic Characteristics						
C _{iss}	Input Capacitance	V _{DS} =15V, V _{GS} =0V, f=1.0MHz		2600		pF
C _{oss}	Output Capacitance			412		pF
C _{rss}	Reverse Transfer Capacitance			300		pF
R _g	Gate resistance	V _{GS} =0V, V _{DS} =0V, f=1.0MHz		3.3		Ω
Switching Times						
t _{d(on)}	Turn-on Delay Time	V _{GS} =10V, V _{DS} =15V, R _L =0.75Ω, R _{GEN} =3Ω		13		nS
t _r	Turn-on Rise Time			16		nS
t _{d(off)}	Turn-Off Delay Time			40		nS
t _f	Turn-Off Fall Time			14		nS
Q _g	Total Gate Charge	V _{GS} =10V, V _{DS} =15V, I _D =14A		58		nC
Q _{gs}	Gate-Source Charge			7		nC
Q _{gd}	Gate-Drain Charge			18		nC
Source-Drain Diode Characteristics						
I _{SD}	Source-Drain Current(Body Diode)				100	A
V _{SD}	Forward on Voltage ^(Note 1)	V _{GS} =0V, I _S =20A			1.2	V

Notes 1. Repetitive Rating: Pulse width limited by maximum junction temperature.

TYPICAL ELECTRICAL AND THERMAL CHARACTERISTICS (Curves)

Figure 1. Output Characteristics

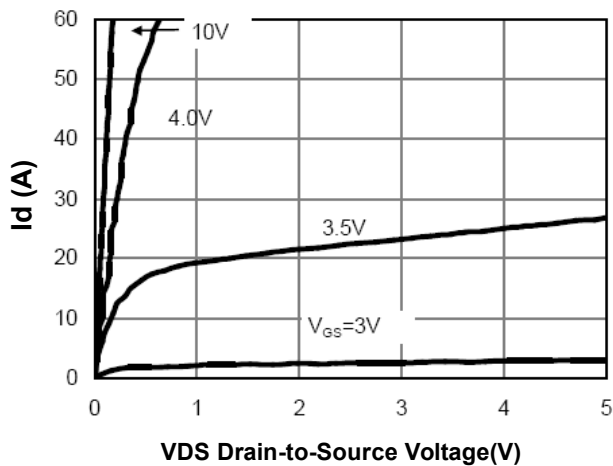

Figure 2. Transfer Characteristics

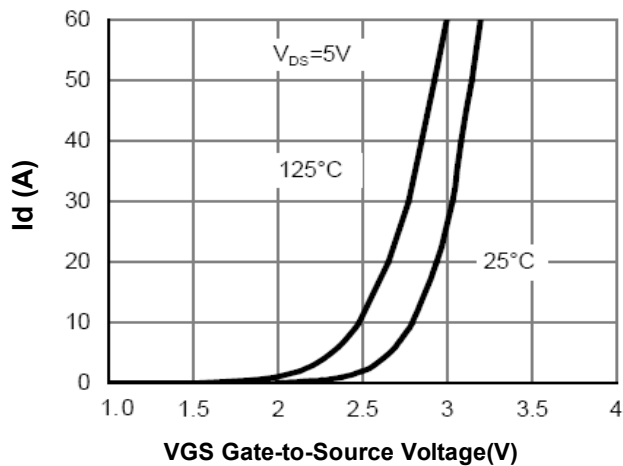

Figure 3. Max BV_{DSS} vs Junction Temperature

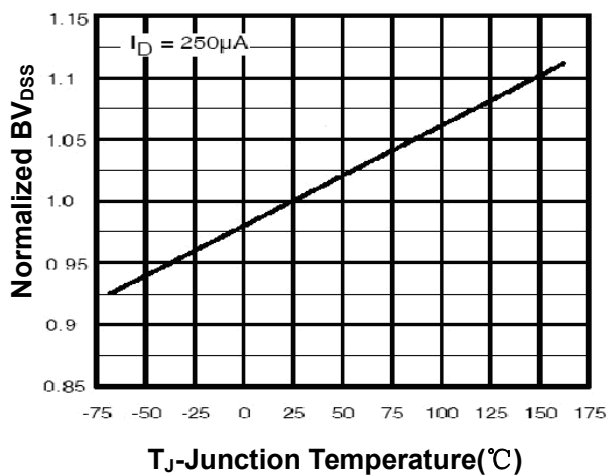

Figure 4. Drain Current

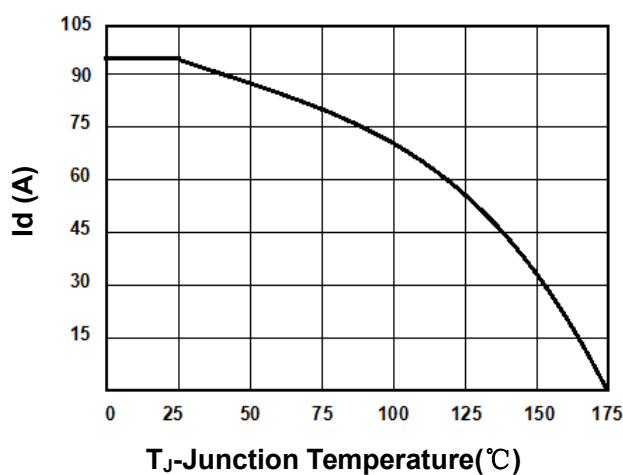

Figure 5. $V_{GS(th)}$ vs Junction Temperature

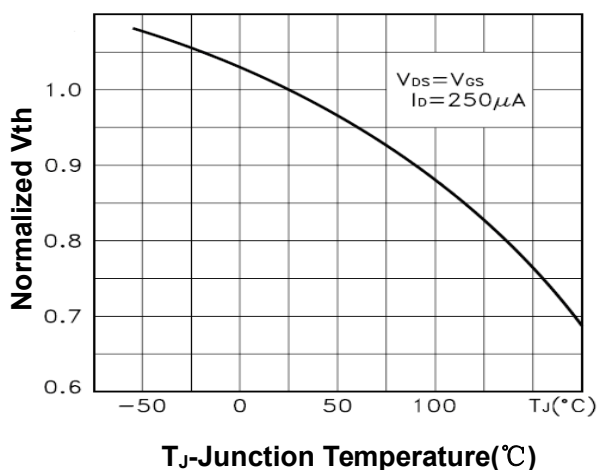

Figure 6. $R_{DS(ON)}$ vs Junction Temperature

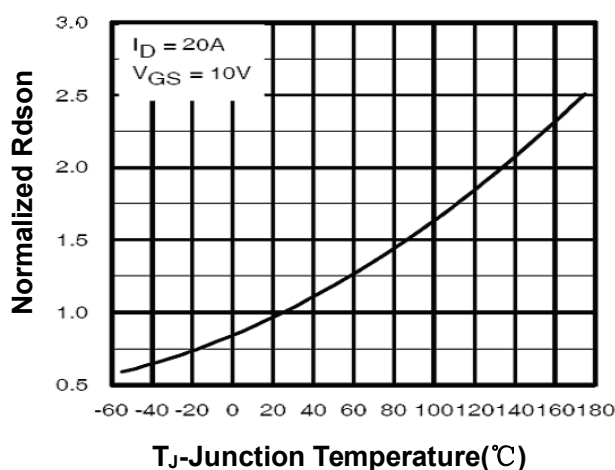

Figure 7. Gate Charge Waveforms

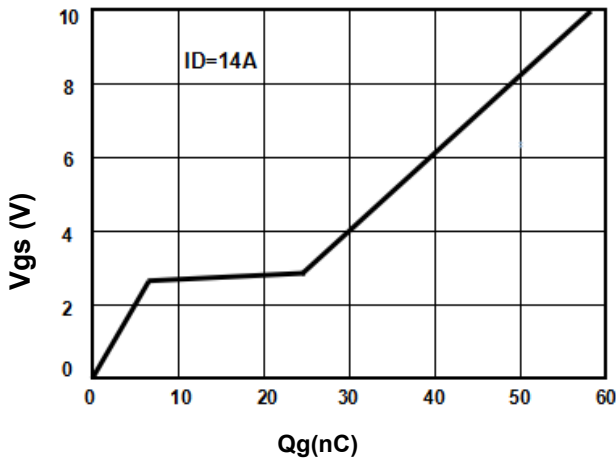

Figure 8. Capacitance

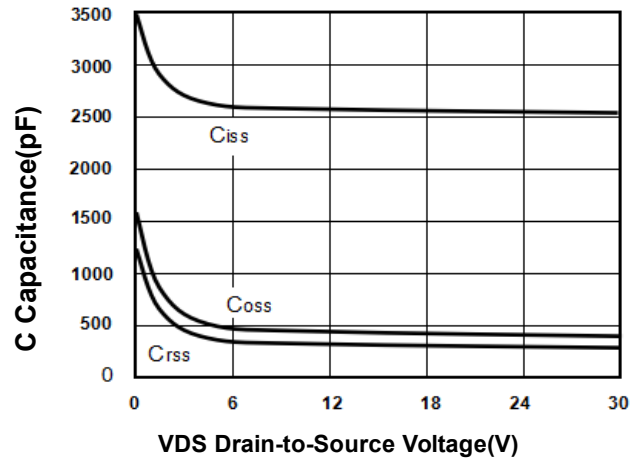

Figure 9. Body-Diode Characteristics

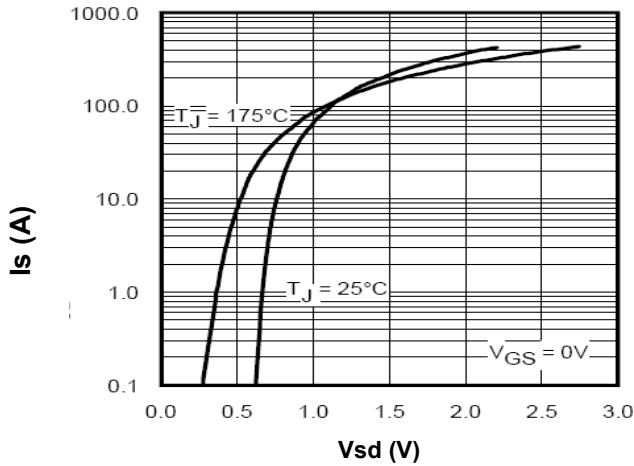

Figure 10. Maximum Safe Operating Area

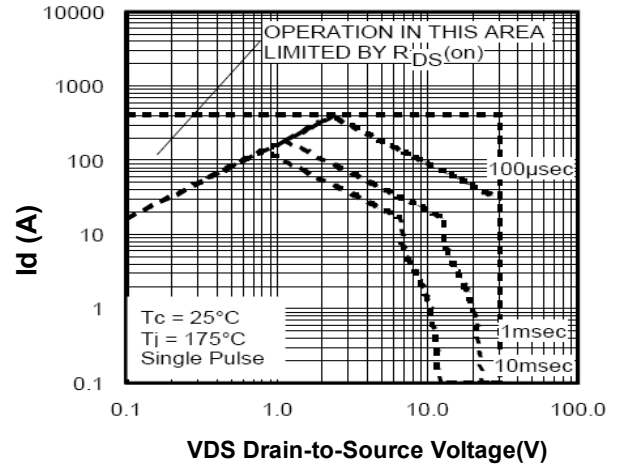
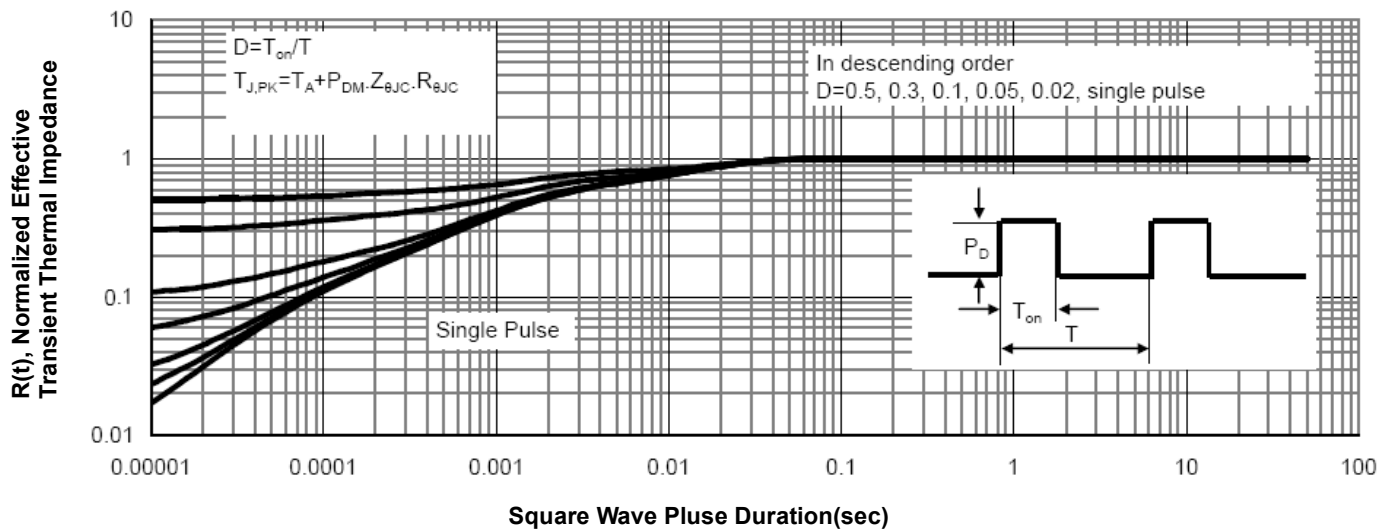
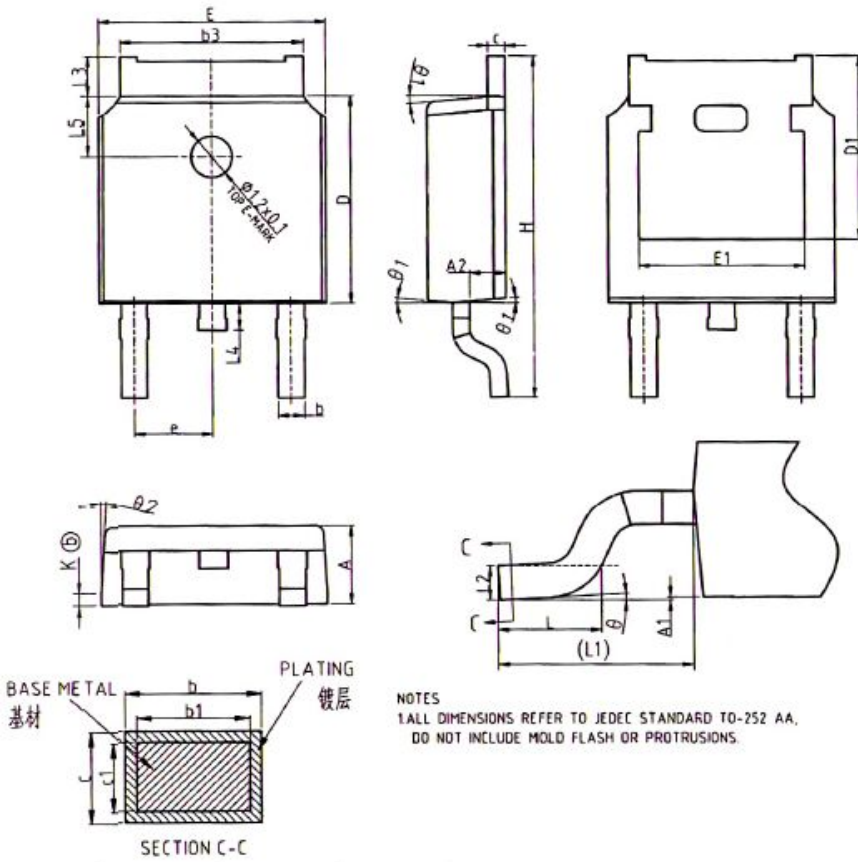

Figure 11. Normalized Maximum Transient Thermal Impedance



TO-252 Package Information



COMMON DIMENSIONS			
SYMBOL	mm		
	MIN	NOM	MAX
A	2.20	2.30	2.38
A1	0.00	-	0.10
A2	0.97	1.07	1.17
b	0.72	0.78	0.85
b1	0.71	0.76	0.81
b3	5.23	5.33	5.46
c	0.47	0.53	0.58
c1	0.46	0.51	0.56
D	6.00	6.10	6.20
D1	5.30REF		
E	6.50	6.60	6.70
E1	4.70	4.83	4.92
e	2.286BSC		
H	9.90	10.10	10.30
L	1.40	1.50	1.70
L1	2.90REF		
L2	0.51BSC		
L3	0.90	-	1.25
L4	0.60	0.80	1.00
L5	1.70	1.80	1.90
θ	0°	-	8°
θ_1	5°	7°	9°
θ_2	5°	7°	9°
K	0.40REF		

NOTES
1. ALL DIMENSIONS REFER TO JEDEC STANDARD TO-252 AA.
DO NOT INCLUDE MOLD FLASH OR PROTRUSIONS.

Disclaimers:

Reasunos Semiconductor Technology CO.,LTD(Reasunos)reserves the right to make changes without notice in order to improve reliability,function or design and to discontinue any product or service without notice .Customers should obtain the latest relevant information before orders and should verify that such information in current and complete.All products are sold subject to Reasunos's terms and conditions supplied at the time of order acknowledgement.

Reasunos Semiconductor Technology CO.,LTD warrants performance of its hardware products to the specifications at the time of sale.Testing,reliability and quality control are used to the extene Reasunos deems necessary to support this warrantee. Except where agreed upon by contractual agreement,testing of all parameters of each product is not necessarily performed.

Reasunos Semiconductor Technology CO.,LTD does not assume any liability arising from the use of any product or circuit designs described herein.Customers are responsible for their products and applications using Reasunos's components.To minimize risk,customers must provide adequate design and operating safeguards.

Reasunos Semiconductor Technology CO.,LTD does not warrant or convey any license either expressed or implied under its patent rights,nor the rights of others.Reproduction of information in Reasunos's data sheeets or data books is permissible only if reproduction is without modification oralteration.Reproduction of this information with any alteration is an unfair and deceptive business practice. Reasunos Semiconductor Technology CO.,LTD is not responsible or liable for such altered documentation.

Resale of Reasunos's products with statements different from or beyond the parameters stated by Reasunos Semiconductor Technology CO.,LTD for that product or service voids all express or implied warrantees for the associated Reasunos's product or service and is unfair and deceptive business practice. Reasunos Semiconductor Technology CO.,LTD is not responsible or liable for such statements.

Life Support Policy:

Reasunos Semiconductor Technology CO.,LTD's Products are not authorized for use as critical components in life support devices or systems without the expressed written approval of Reasunos Semiconductor Technology CO.,LTD.

As used herein:

- 1.Life support devices or systems are devices or systems which:
 - a.are intended for surgical implant into the human body,
 - b.support or sustain life,
 - c.whose failuer to when properly used in accordance with instructions for used provided in the laeling,can be reasonably expected to result in significant injury to the user.

system whose failure to perform can be reasonably expected to cause the failure of the life support device or system,or to affect its safety or effectiveness.