

Precision, Zero-Drift, Rail-to-Rail Out, High-Voltage(32V) Operational Amplifier

1 FEATURES

- **Gain-Bandwidth Product:2.0MHz**
- **Low Offset Voltage:20μV (Max)**
- **Input Offset Drift: ±0.15μV/°C**
- **Low Input Noise:0.6μVpp (0.1Hz to 10Hz)**
- **Low Supply Current:4mA (TYP)**
- **Rail to Rail Output**
- **Excellent DC Precision:**
 - PSRR:130dB
 - CMRR:120dB
 - Open-Loop Gain:130dB
- **Single-Supply Operation: 3.3V to 32V**
- **Dual-Supply Operation: ±1.65V to ±16V**
- **SPECIFIED UP TO +125°C**
- **Micro SIZE PACKAGES:**
 - SOIC-14(SOP14)、TSSOP-14

2 APPLICATIONS

- **Temperature Measurements**
- **Semiconductor Test**
- **Pressure Sensors**
- **Medical Equipment**
- **Test Equipment**
- **Driving A/D Converters**
- **Precision Current Sensing**

3 DESCRIPTIONS

The RS8654 series of CMOS operational amplifiers use auto-zero techniques to simultaneously provide very low offset voltage (20μV max) and near-zero drift over time and temperature. This family of amplifiers has ultra-low noise, offset and power.

This miniature, high-precision operational amplifiers offer high input impedance and rail-to-rail output swing. With high gain-bandwidth product of 2.0MHz and slew rate of 1.0V/μs. Either single or dual supplies can be used in the range from 3.3V to 32V (±1.65V to ±16V).

The RS8654 families of operational amplifiers are specified at the full temperature range of -40°C to +125°C.

Device Information ⁽¹⁾

| PART NUMBER | PACKAGE | BODY SIZE(NOM) |
|-------------|--------------------|----------------|
| RS8654 | SOIC-14 (SOP14) | 8.65mm×3.90mm |
| | TSSOP-14 | 5.00mm×4.40mm |

(1) For all available packages, see the orderable addendum at the end of the data sheet.

Table of Contents

| | |
|--|----|
| 1 FEATURES | 1 |
| 2 APPLICATIONS | 1 |
| 3 DESCRIPTIONS | 1 |
| 4 Revision History | 3 |
| 5 PACKAGE/ORDERING INFORMATION ⁽¹⁾ | 4 |
| 6 Pin Configuration and Functions (Top View) | 5 |
| 7 SPECIFICATIONS | 6 |
| 7.1 Absolute Maximum Ratings | 6 |
| 7.2 ESD Ratings | 6 |
| 7.3 Recommended Operating Conditions | 6 |
| 7.4 ELECTRICAL CHARACTERISTICS | 7 |
| 7.5 TYPICAL CHARACTERISTICS | 9 |
| 8 PACKAGE OUTLINE DIMENSIONS | 11 |
| 9 TAPE AND REEL INFORMATION | 13 |

4 Revision History

Note: Page numbers for previous revisions may differ from page numbers in the current version.

| VERSION | Change Date | Change Item |
|---------|-------------|---------------------------|
| A.1 | 2022/12/05 | Initial version completed |

5 PACKAGE/ORDERING INFORMATION ⁽¹⁾

| Orderable Device | Package Type | Pin | Channel | Op Temp(°C) | Device Marking ⁽²⁾ | Package Qty |
|------------------|----------------|-----|---------|--------------|-------------------------------|--------------------|
| RS8654XP | SOIC-14(SOP14) | 14 | 4 | -40°C ~125°C | RS8654 | Tape and Reel,4000 |
| RS8654XQ | TSSOP-14 | 14 | 4 | -40°C ~125°C | RS8654 | Tape and Reel,4000 |

NOTE:

- (1) This information is the most current data available for the designated devices. This data is subject to change without notice and revision of this document. For browser-based versions of this data sheet, refer to the right-hand navigation.
- (2) There may be additional marking, which relates to the lot trace code information (data code and vendor code), the logo or the environmental category on the device.

6 Pin Configuration and Functions (Top View)

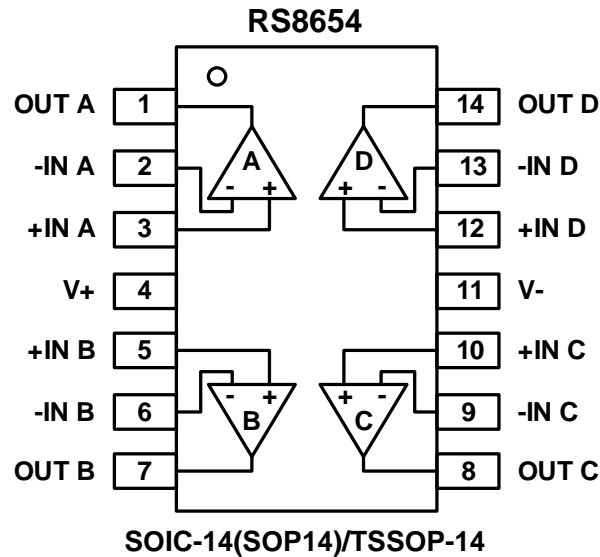

Pin Description

| NAME | PIN | I/O ⁽¹⁾ | DESCRIPTION |
|------|-------------------------|--------------------|---------------------------------|
| | SOIC-14(SOP14)/TSSOP-14 | | |
| -INA | 2 | I | Inverting input, channel A |
| +INA | 3 | I | Noninverting input, channel A |
| -INB | 6 | I | Inverting input, channel B |
| +INB | 5 | I | Noninverting input, channel B |
| -INC | 9 | I | Inverting input, channel C |
| +INC | 10 | I | Noninverting input, channel C |
| -IND | 13 | I | Inverting input, channel D |
| +IND | 12 | I | Noninverting input, channel D |
| OUTA | 1 | O | Output, channel A |
| OUTB | 7 | O | Output, channel B |
| OUTC | 8 | O | Output, channel C |
| OUTD | 14 | O | Output, channel D |
| V- | 11 | - | Negative (lowest) power supply |
| V+ | 4 | - | Positive (highest) power supply |

(1) I = Input, O = Output.

7 SPECIFICATIONS

7.1 Absolute Maximum Ratings

Over operating free-air temperature range (unless otherwise noted) ⁽¹⁾

| | | MIN | MAX | UNIT | | |
|---------------|--|----------------------|-----------|-----------|------|--|
| Voltage | Supply, $V_s=(V+) - (V-)$ | Dual supply | | ±18 | V | |
| | | Single supply | | 36 | | |
| | Signal input pin ⁽²⁾ | Common-mode voltage | (V-)-0.5 | (V+) +0.5 | | |
| | | Differential voltage | | ±0.7 | | |
| | Signal output pin ⁽³⁾ | (V-)-0.5 | (V+) +0.5 | | | |
| Current | Signal input pin ⁽²⁾ | -10 | 10 | mA | | |
| | Signal output pin ⁽³⁾ | -50 | 50 | mA | | |
| | Output short-circuits ⁽⁴⁾ | Continuous | | | | |
| θ_{JA} | Package thermal impedance ⁽⁵⁾ | SOIC-14(SOP14) | | 104.5 | °C/W | |
| | | TSSOP14 | | 89.21 | | |
| Temperature | Operating range, T_A | -40 | 125 | | | |
| | Junction, T_J ⁽⁶⁾ | -40 | 150 | °C | | |
| | Storage, T_{stg} | -65 | 150 | | | |

(1) Stresses above these ratings may cause permanent damage. Exposure to absolute maximum conditions for extended periods may degrade device reliability. These are stress ratings only, and functional operation of the device at these or any other conditions beyond those specified is not implied.

(2) Input terminals are diode-clamped to the power-supply rails. Input signals that can swing more than 0.5V beyond the supply rails should be current-limited to 10mA or less.

(3) Output terminals are diode-clamped to the power-supply rails. Output signals that can swing more than 0.5V beyond the supply rails should be current-limited to ±50mA or less.

(4) Short-circuit to ground, one amplifier per package.

(5) The package thermal impedance is calculated in accordance with JESD-51.

(6) The maximum power dissipation is a function of $T_{J(MAX)}$, $R_{\theta JA}$, and T_A . The maximum allowable power dissipation at any ambient temperature is $P_D = (T_{J(MAX)} - T_A) / R_{\theta JA}$. All numbers apply for packages soldered directly onto a PCB.

7.2 ESD Ratings

The following ESD information is provided for handling of ESD-sensitive devices in an ESD protected area only.

| | | | VALUE | UNIT |
|-------------|-------------------------|---|-------|------|
| $V_{(ESD)}$ | Electrostatic discharge | Human-body model (HBM), per ANSI/ESDA/JEDEC JS-001 ⁽¹⁾ | ±3000 | V |
| | | Charged-device model (CDM), per ANSI/ESDA/JEDEC JS-002 ⁽²⁾ | ±1500 | |
| | | Machine Model (MM) | ±500 | |

(1) JEDEC document JEP155 states that 500 V HBM allows safe manufacturing with a standard ESD control process.

(2) JEDEC document JEP157 states that 250 V CDM allows safe manufacturing with a standard ESD control process.



ESD SENSITIVITY CAUTION

ESD damage can range from subtle performance degradation to complete device failure. Precision integrated circuits may be more susceptible to damage because very small parametric changes could cause the device not to meet its published specifications.

7.3 Recommended Operating Conditions

Over operating free-air temperature range (unless otherwise noted)

| | | MIN | NOM | MAX | UNIT |
|-----------------------------------|---------------|-------|-----|-----|------|
| Supply voltage, $V_s=(V+) - (V-)$ | Single-supply | 3.3 | | 32 | V |
| | Dual-supply | ±1.65 | | ±16 | |

7.4 ELECTRICAL CHARACTERISTICS

At $T_A = +25^\circ\text{C}$, $V_S = 3.3\text{V}$ to 32V , $R_L = 10\text{k}\Omega$ connected to $V_S/2$, and $V_{CM} = V_{OUT} = V_S/2$, Full ⁽⁹⁾ = -40°C to $+125^\circ\text{C}$ (unless otherwise noted) ⁽¹⁾

| PARAMETER | CONDITIONS | T_J | RS8654 | | | UNIT | |
|---------------------------|---|---|--------------------|--------------------|--------------------|----------|------------------------------|
| | | | MIN ⁽²⁾ | TYP ⁽³⁾ | MAX ⁽²⁾ | | |
| POWER SUPPLY | | | | | | | |
| V_S | Operating Voltage Range | 25°C | 3.3 | | 32 | V | |
| IQ | Quiescent Current | $V_S = \pm 2.5\text{V}$, $I_o = 0\text{mA}$ | 25°C | | 4.0 | 5.6 | mA |
| | | | Full | | | 6.0 | |
| | | $V_S = \pm 16\text{V}$, $I_o = 0\text{mA}$ | 25°C | | 5.0 | 8.0 | |
| | | | Full | | | 10.0 | |
| PSRR | Power-Supply Rejection Ratio | $V_S = 5\text{V}$ to 32V | 25°C | 110 | 130 | | dB |
| | | | Full | 100 | | | |
| INPUT | | | | | | | |
| Vos | Input Offset Voltage | $V_{CM} = V_S/2$ | 25°C | -20 | ± 3 | 20 | μV |
| | | | Full | | ± 25 | | |
| Vos Tc | Input Offset Voltage Average Drift | $V_{CM} = V_S/2$ | Full | | ± 0.15 | | $\mu\text{V}/^\circ\text{C}$ |
| IB | Input Bias Current ⁽⁴⁾ ⁽⁵⁾ | $V_{CM} = 0\text{V}$ | 25°C | | 100 | 1000 | pA |
| | | | Full | | 600 | | |
| Ios | Input Offset Current ⁽⁴⁾ | $V_{CM} = 0\text{V}$ | 25°C | | 100 | | pA |
| | | | Full | | 600 | | |
| V_{CM} | Common-Mode Voltage Range | $V_S = \pm 16\text{V}$ | 25°C | (V-) | | (V+)-1.5 | V |
| CMRR | Common-Mode Rejection Ratio | $V_S = \pm 16\text{V}$ $V_{CM} = (V-) + 0.3$ to $(V+) - 1.5\text{V}$ | 25°C | 95 | 120 | | dB |
| | | | Full | 90 | | | |
| OUTPUT | | | | | | | |
| AOL | Open-Loop Voltage Gain | $R_L = 10\text{k}\Omega$ $V_O = (V-) + 0.4\text{V}$ to $(V+) - 0.4\text{V}$ | 25°C | 100 | 130 | | dB |
| | | | Full | 90 | | | |
| V_{OH} | Output Swing from Rail | $V_S = \pm 16\text{V}$, $R_L = 10\text{k}\Omega$ | 25°C | 15.80 | | | V |
| V_{OL} | | | 25°C | | | -15.70 | |
| Isc | Short-Circuit Current ⁽⁶⁾ ⁽⁷⁾ | $V_S = \pm 2.5\text{V}$, $V_o = 0\text{V}$ $V_S = \pm 16\text{V}$, $V_o = 0\text{V}$ | 25°C | 15 | 20 | | mA |
| | | | | 60 | 80 | | |
| Ro | Open-Loop Output Impedance ⁽⁴⁾ | $f = 1\text{MHz}$, $I_o = 0\text{mA}$ | | | 120 | | Ω |
| C_{LOAD} | Capacitive Load Drive ⁽⁴⁾ | | | | 1 | | nF |
| FREQUENCY RESPONSE | | | | | | | |
| SR | Slew Rate ⁽⁸⁾ | $V_S = \pm 2.5\text{V}$, $G = +1$, $C_L = 100\text{pF}$ | 25°C | | 1.0 | | V/us |
| GBW | Gain-Bandwidth Product | $V_S = \pm 2.5\text{V}$ | 25°C | | 2.0 | | MHz |
| ts | Settling Time, 0.1% | $V_S = \pm 2.5\text{V}$, $G = +1$, $C_L = 100\text{pF}$, Step=2V | 25°C | | 6.6 | | us |
| tor | Overload Recovery Time | $V_{IN} \cdot \text{Gain} \geq V_S$, $G = -10$ | 25°C | | 1.6 | | us |
| NOISE | | | | | | | |
| En | Input Voltage Noise | $f = 0.1\text{Hz}$ to 10Hz , $V_S = \pm 2.5\text{V}$ | 25°C | | 0.6 | | μV_{pp} |
| en | Input Voltage Noise Density ⁽⁴⁾ | $f = 1\text{KHz}$ | 25°C | | 30 | | $\text{nV}/\sqrt{\text{Hz}}$ |
| | | $f = 10\text{KHz}$ | | | 14 | | |

NOTE:

- (1) Electrical table values apply only for factory testing conditions at the temperature indicated. Factory testing conditions result in very limited self-heating of the device.
- (2) Limits are 100% production tested at 25°C. Limits over the operating temperature range are ensured through correlations using statistical quality control (SQC) method.
- (3) Typical values represent the most likely parametric norm as determined at the time of characterization. Actual typical values may vary over time and will also depend on the application and configuration.
- (4) This parameter is ensured by design and/or characterization and is not tested in production.
- (5) Positive current corresponds to current flowing into the device.
- (6) The maximum power dissipation is a function of $T_{J(MAX)}$, $R_{\theta JA}$, and T_A . The maximum allowable power dissipation at any ambient temperature is $PD = (T_{J(MAX)} - T_A) / R_{\theta JA}$. All numbers apply for packages soldered directly onto a PCB.
- (7) Short circuit test is a momentary test.
- (8) Number specified is the slower of positive and negative slew rates.
- (9) Specified by characterization only.

7.5 TYPICAL CHARACTERISTICS

NOTE: The graphs and tables provided following this note are a statistical summary based on a limited number of samples and are provided for informational purposes only.

At $T_A = -40^{\circ}\text{C}$ to 125°C , $V_S = 5\text{V}$, $R_L = 10\text{k}\Omega$ connected to $V_S/2$, $V_{OUT} = V_S/2$, unless otherwise noted.

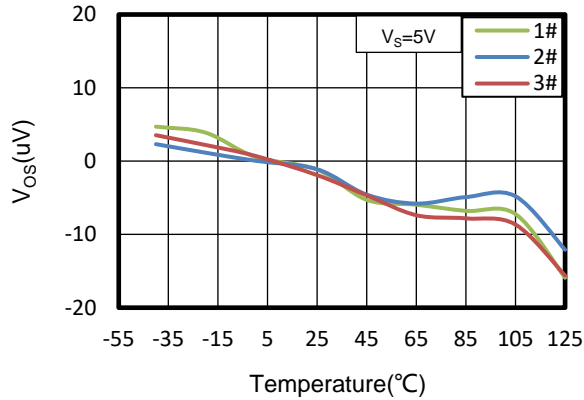

Figure 1. Offset Voltage vs Temperature

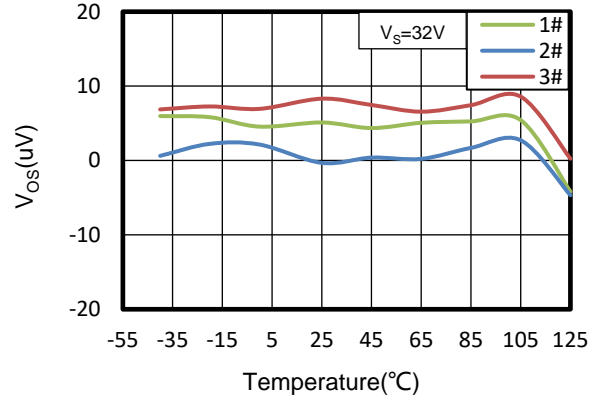

Figure 2. Offset Voltage vs Temperature

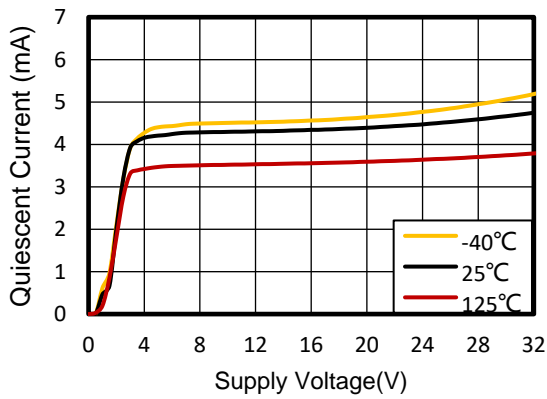

Figure 3. Supply Voltage vs Quiescent Current

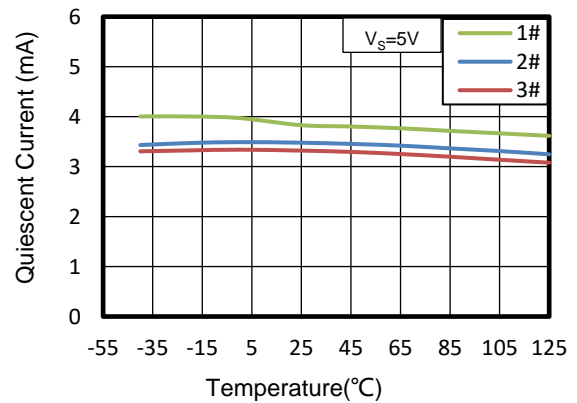

Figure 4. Quiescent Current vs Temperature

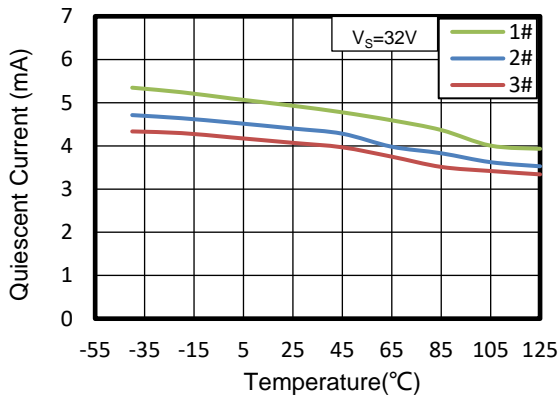

Figure 5. Quiescent Current vs Temperature

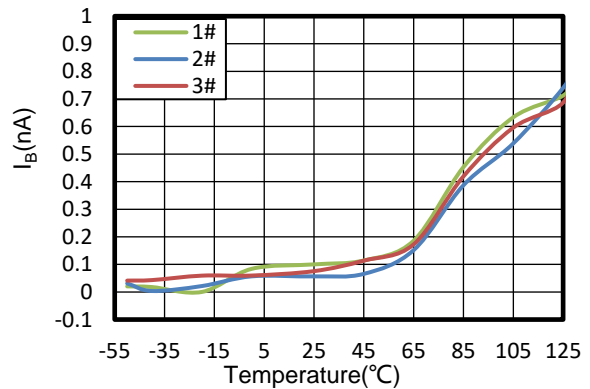

Figure 6. Input Bias Current vs Temperature

TYPICAL CHARACTERISTICS

NOTE: The graphs and tables provided following this note are a statistical summary based on a limited number of samples and are provided for informational purposes only.

At $T_A = -40^{\circ}\text{C}$ to 125°C , $V_S = 5\text{V}$, $R_L = 10\text{k}\Omega$ connected to $V_S/2$, $V_{OUT} = V_S/2$, unless otherwise noted.

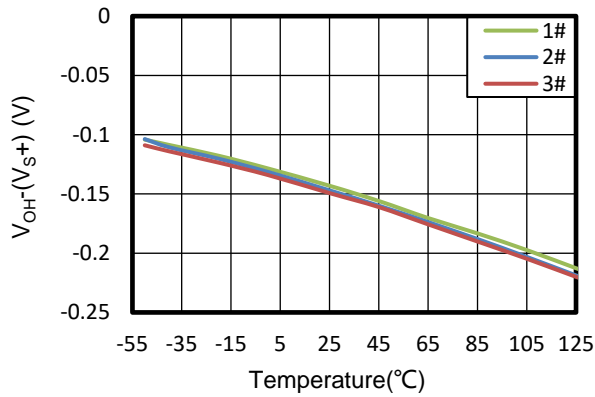

Figure 7. Output Swing From Rail vs Temperature

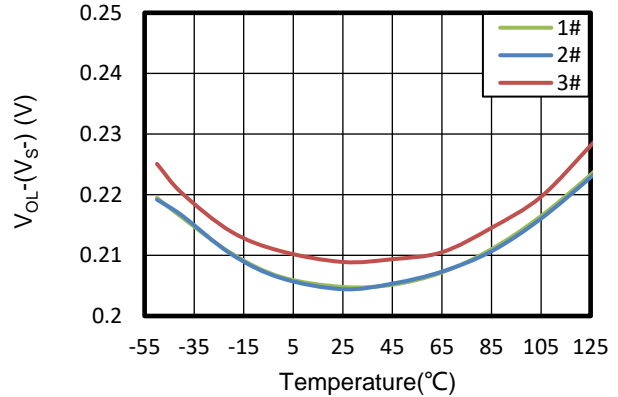

Figure 8. Output Swing From Rail vs Temperature

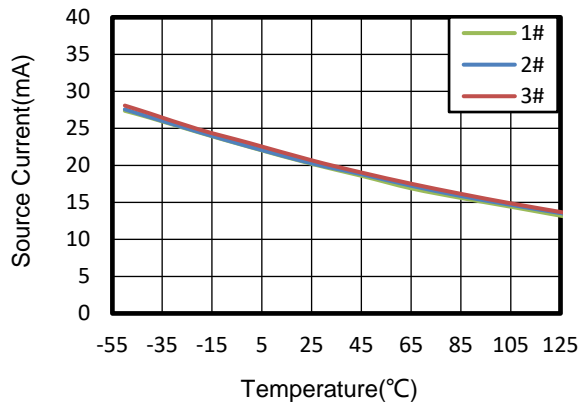

Figure 9. Source Current vs Temperature

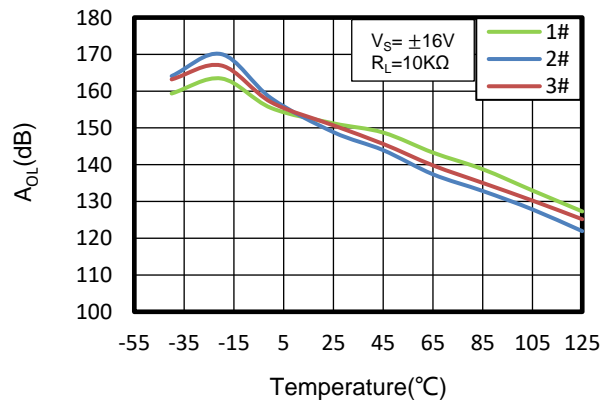

Figure 10. Open-Loop Gain vs Temperature

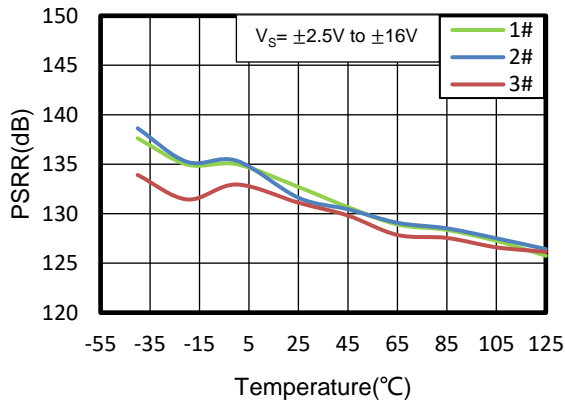

Figure 11. Power-Supply Rejection Ratio vs Temperature

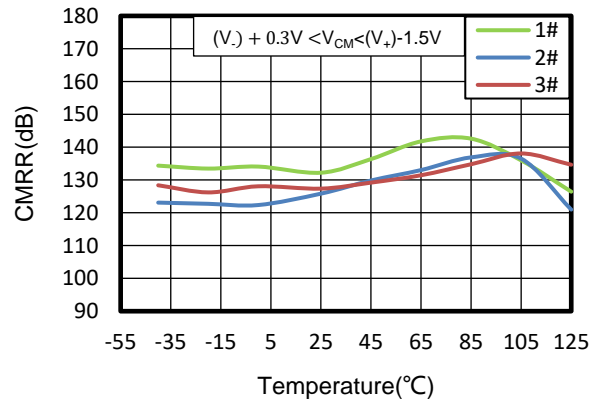
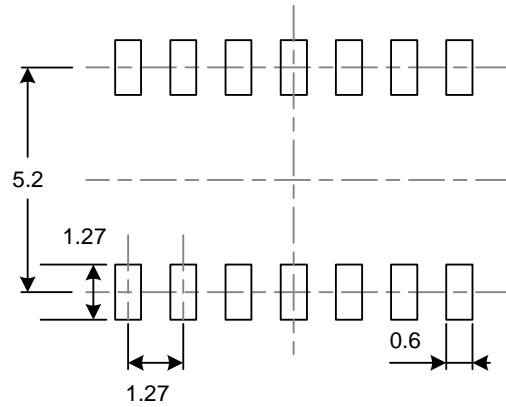
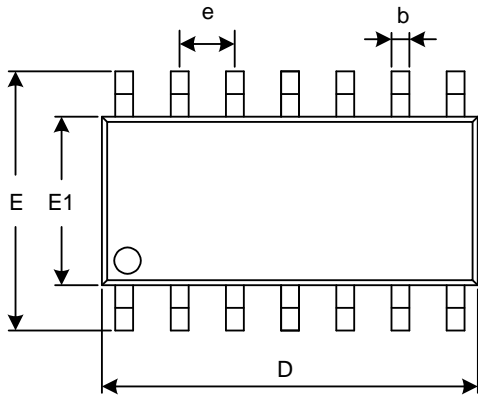
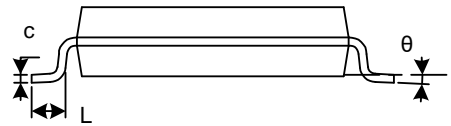
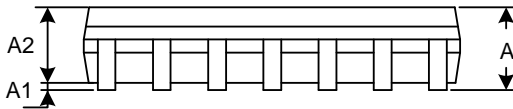

Figure 12. Common-Mode Rejection Ratio vs Temperature

8 PACKAGE OUTLINE DIMENSIONS SOIC-14(SOP14)



RECOMMENDED LAND PATTERN (Unit: mm)



| Symbol | Dimensions In Millimeters | | Dimensions In Inches | |
|----------|---------------------------|-------|----------------------|-------|
| | Min | Max | Min | Max |
| A | 1.350 | 1.750 | 0.053 | 0.069 |
| A1 | 0.100 | 0.250 | 0.004 | 0.010 |
| A2 | 1.350 | 1.550 | 0.053 | 0.061 |
| b | 0.310 | 0.510 | 0.012 | 0.020 |
| c | 0.100 | 0.250 | 0.004 | 0.010 |
| D | 8.450 | 8.850 | 0.333 | 0.348 |
| e | 1.270(BSC) | | 0.050(BSC) | |
| E | 5.800 | 6.200 | 0.228 | 0.244 |
| E1 | 3.800 | 4.000 | 0.150 | 0.157 |
| L | 0.400 | 1.270 | 0.016 | 0.050 |
| θ | 0° | 8° | 0° | 8° |

TSSOP-14

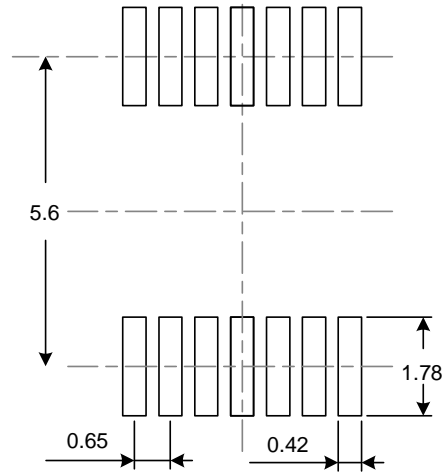
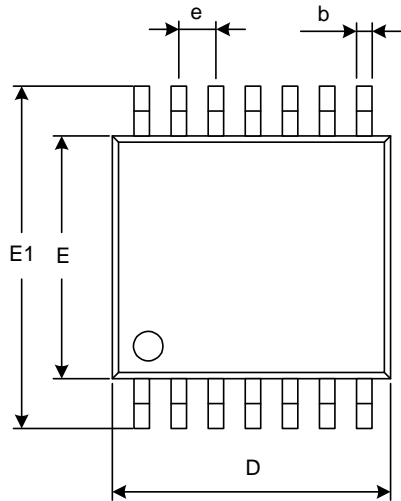

RECOMMENDED LAND PATTERN (Unit: mm)

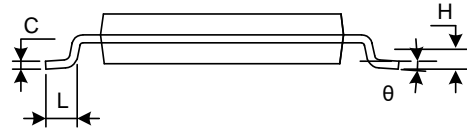
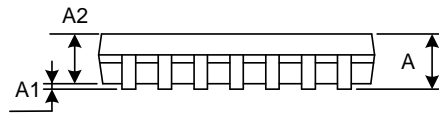

| Symbol | Dimensions In Millimeters | | Dimensions In Inches | |
|----------|---------------------------|-------|----------------------|-------|
| | Min | Max | Min | Max |
| A | | 1.200 | | 0.047 |
| A1 | 0.050 | 0.150 | 0.002 | 0.006 |
| A2 | 0.800 | 1.050 | 0.031 | 0.041 |
| b | 0.190 | 0.300 | 0.007 | 0.012 |
| c | 0.090 | 0.200 | 0.004 | 0.008 |
| D | 4.860 | 5.100 | 0.191 | 0.201 |
| E | 4.300 | 4.500 | 0.169 | 0.177 |
| E1 | 6.250 | 6.550 | 0.246 | 0.258 |
| e | 0.650(BSC) | | 0.026(BSC) | |
| L | 0.500 | 0.700 | 0.020 | 0.028 |
| H | 0.25(TYP) | | 0.01(TYP) | |
| θ | 1° | 7° | 1° | 7° |

NOTE:

- A. All linear dimension is in millimeters.
- B. This drawing is subject to change without notice.
- C. Body dimensions do not include mold flash or protrusion. Mold flash and protrusion shall not exceed 0.15 per side.
- D. BSC: Basic Dimension. Theoretically exact value shown without tolerances.

9 TAPE AND REEL INFORMATION

REEL DIMENSIONS

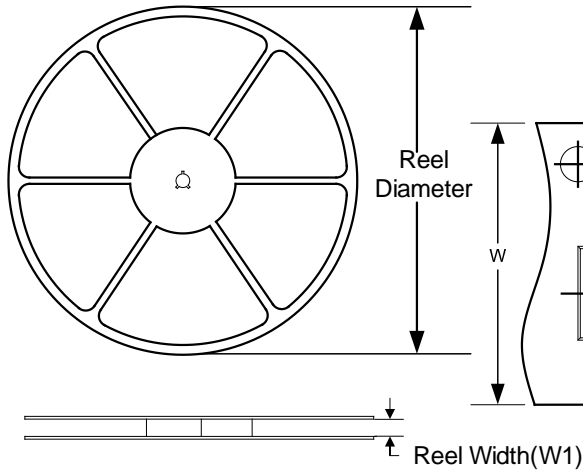

TAPE DIMENSION

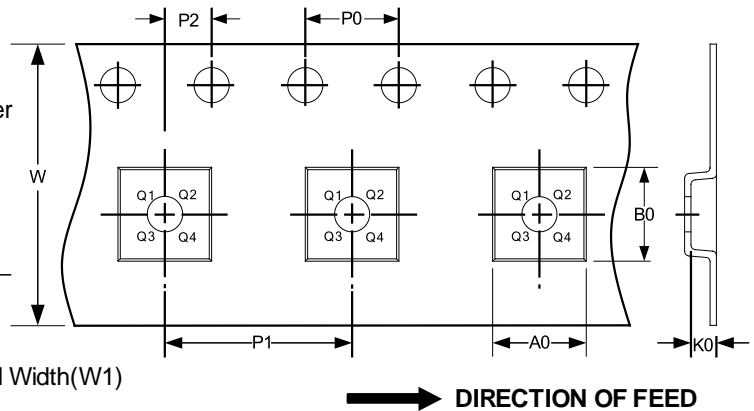

NOTE: The picture is only for reference. Please make the object as the standard.

KEY PARAMETER LIST OF TAPE AND REEL

| Package Type | Reel Diameter | Reel Width (mm) | A0 (mm) | B0 (mm) | K0 (mm) | P0 (mm) | P1 (mm) | P2 (mm) | W (mm) | Pin1 Quadrant |
|----------------|---------------|-----------------|---------|---------|---------|---------|---------|---------|--------|---------------|
| SOIC-14(SOP14) | 13" | 16.4 | 6.60 | 9.30 | 2.10 | 4.0 | 8.0 | 2.0 | 16.0 | Q1 |
| TSSOP-14 | 13" | 12.4 | 6.95 | 5.60 | 1.20 | 4.0 | 8.0 | 2.0 | 12.0 | Q1 |

NOTE:

1. All dimensions are nominal.
2. Plastic or metal protrusions of 0.15mm maximum per side are not included.

IMPORTANT NOTICE AND DISCLAIMER

Jiangsu Runic Technology Co., Ltd. will accurately and reliably provide technical and reliability data (including data sheets), design resources (including reference designs), application or other design advice, WEB tools, safety information and other resources, without warranty of any defect, and will not make any express or implied warranty, including but not limited to the warranty of merchantability Implied warranty that it is suitable for a specific purpose or does not infringe the intellectual property rights of any third party.

These resources are intended for skilled developers designing with Runic products You will be solely responsible for: (1) Selecting the appropriate products for your application; (2) Designing, validating and testing your application; (3) Ensuring your application meets applicable standards and any other safety, security or other requirements; (4) Runic and the Runic logo are registered trademarks of Runic Incorporated. All trademarks are the property of their respective owners; (5) For change details, review the revision history included in any revised document. The resources are subject to change without notice. Our company will not be liable for the use of this product and the infringement of patents or third-party intellectual property rights due to its use.