

Product Summary

- 1.5V to 12V Input
- 1.8V to 8V Logic Level Control
- Low Profile, Small Footprint SOT23-6 Package
- 2000V ESD Protection on Input Switch
- Adjustable Slew-Rate

Application

- Battery Packs
- Battery-Powered Portable Equipment
- Cellular and Cordless Telephones

Package and Pin Configuration

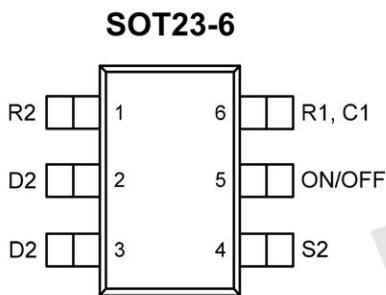

Circuit diagram

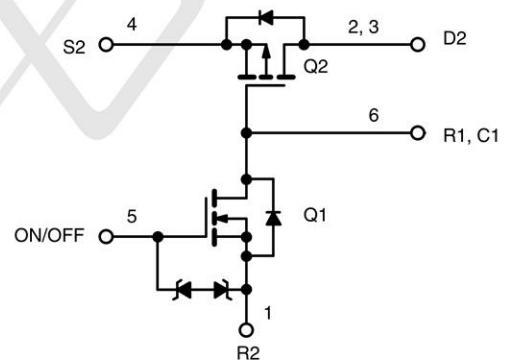

Marking: IKSTP



Absolute Maximum Ratings (T_A=25°C unless otherwise noted)

Symbol	Parameter	Limit	Unit
V _{IN}	Input Voltage	12	V
V _{ON/OFF}	ON/OFF Voltage	8	
I _L	Continuous Load Current	±2.8	A
	Pulse Load Current	±6	
I _S	Continuous Source Current (Source-Drain Diode)	-1.0	
P _D	Maximum Power Dissipation	0.5	W
T _J , T _{STG}	Junction and Storage Temperature Range	-50 to +150	°C
ESD	ESD Rating, MIL-STD-883D HBM	2000	V
R _{0JA}	Thermal Resistance, Junction-to-Ambient	250	°C/W

Typical Application Circuit

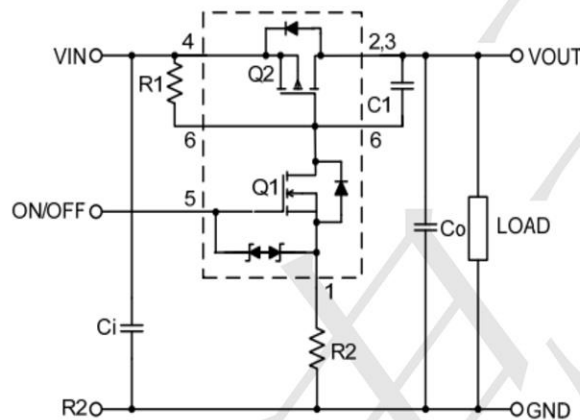

COMPONENTS		
R1	Pull-Up Resistor	Typical 20kΩ to 1MΩ*
R2	Optional Slew-Rate Control	Typical 0 to 50kΩ
C1	Optional Slew-Rate Control	Typical 1000pF

*Minimum R1 value should be at least $10 \times R2$ to ensure Q1 turn-on.

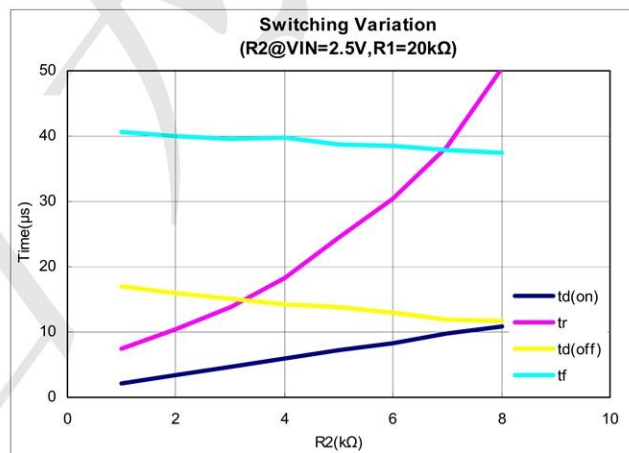

Note 1: For R2 switching variations with other VIN/R1 combinations, see Typical Characteristics.

Electrical Characteristics ($T_A = 25^\circ\text{C}$ unless otherwise noted)

Symbol	Parameter	Test Condition	Min	Typ	Max	Unit
OFF Characteristics						
I_{FL}	Reverse Leakage Current	$V_{IN}=12\text{V}, V_{ON/OFF}=0\text{V}$			1	μA
V_{SD}	Diode Forward Voltage	$I_S = -1\text{A}$		-0.7	-1	V
ON Characteristics						
V_{IN}	Input Voltage Range		1.5		12	V
$R_{DS(ON)}$	Static Drain-to-Source On-Resistance	$V_{ON/OFF}=1.8\text{V}, V_{IN}=4.5\text{V}, I_D=1.0\text{A}$		0.045	0.055	Ω
		$V_{ON/OFF}=1.8\text{V}, V_{IN}=2.5\text{V}, I = 1.0\text{A}$		0.050	0.065	
		$V_{ON/OFF}=1.8\text{V}, V_{IN}=2.5\text{V}, I = 1.0\text{A}$		0.080	0.150	
$I_{D(on)}$	On-State (P-Channel) Drain Current	$V_{IN-OUT}\leq 0.2\text{V}, V_{IN}=5\text{V}, V_{ON/OFF}=1.5\text{V}$	1			A
		$V_{IN-OUT}\leq 0.3\text{V}, V_{IN}=3\text{V}, V_{ON/OFF}=1.8\text{V}$	1			

Typical Operating Characteristics

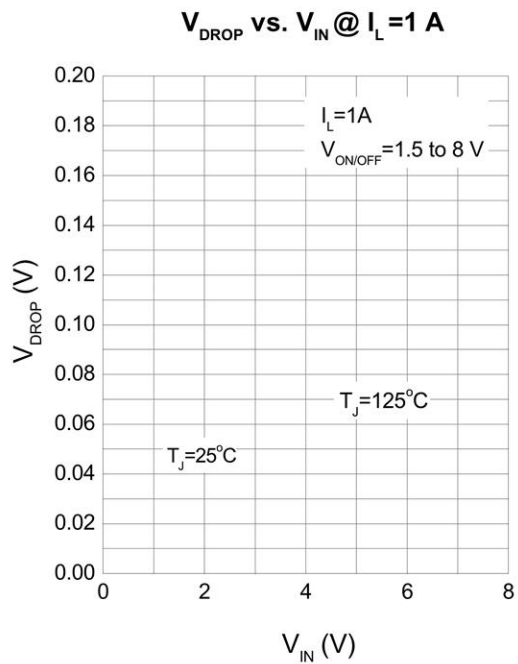
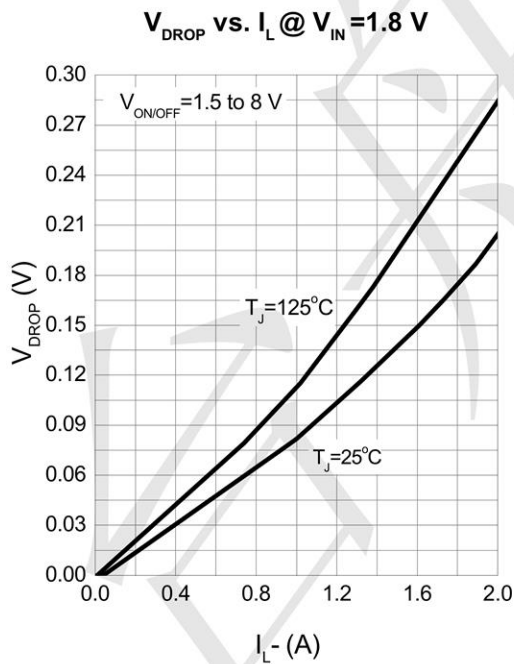
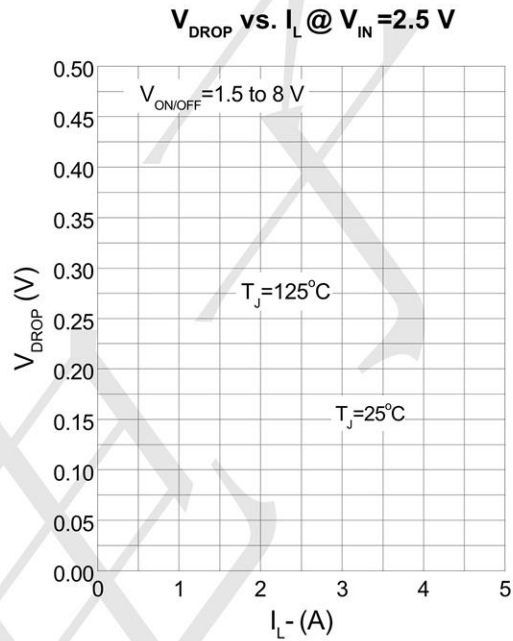
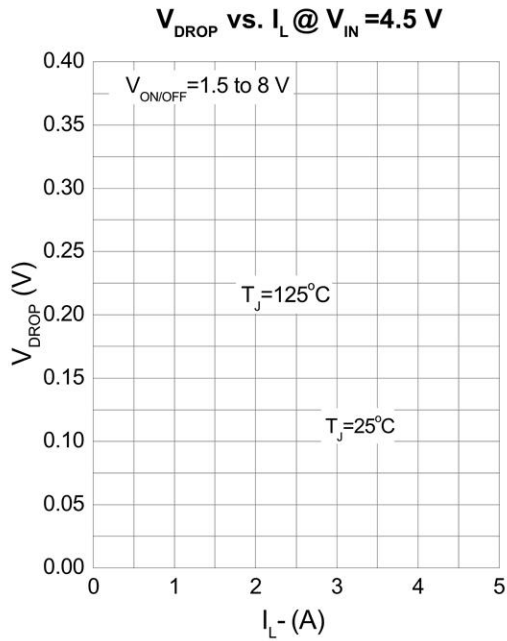

On-Resistance vs. Input Voltage

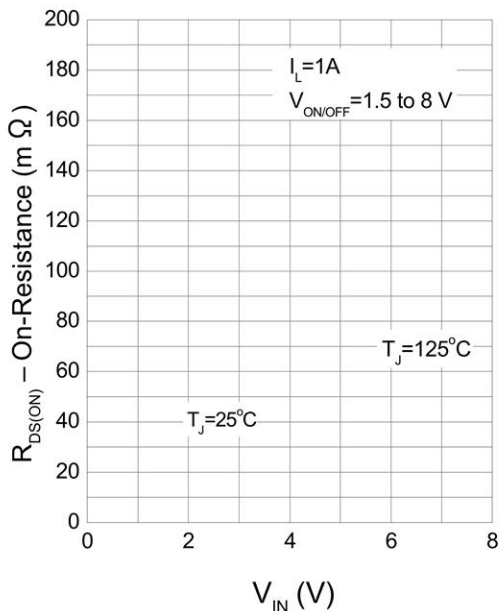

Thermal Transient Impedance

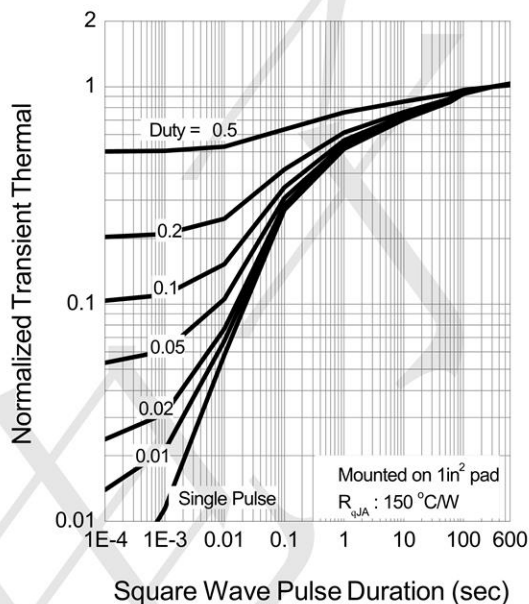

Switching Variation

R2 @ $V_{IN} = 4.5$ V, R1 = 20 k Ω

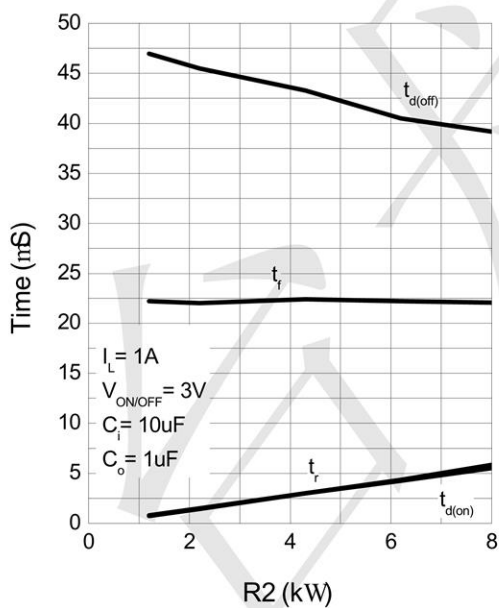

Switching Variation

R2 @ $V_{IN} = 2.5$ V, R1 = 20 k Ω

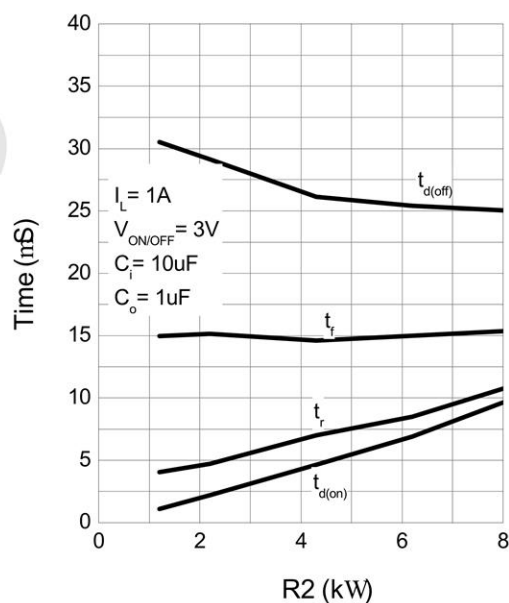

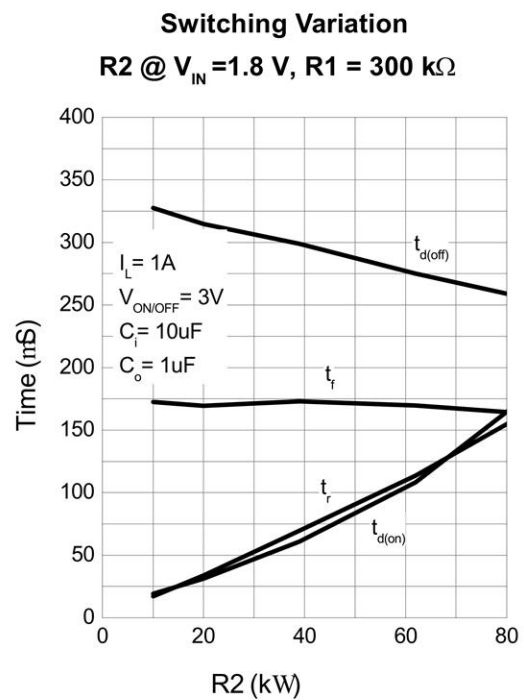
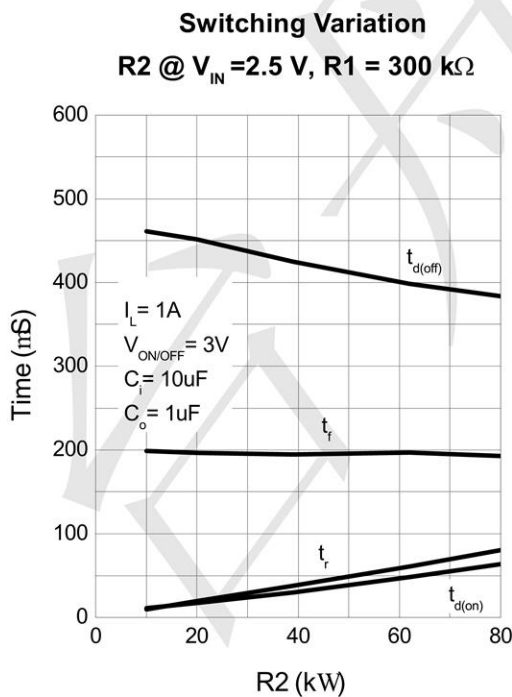
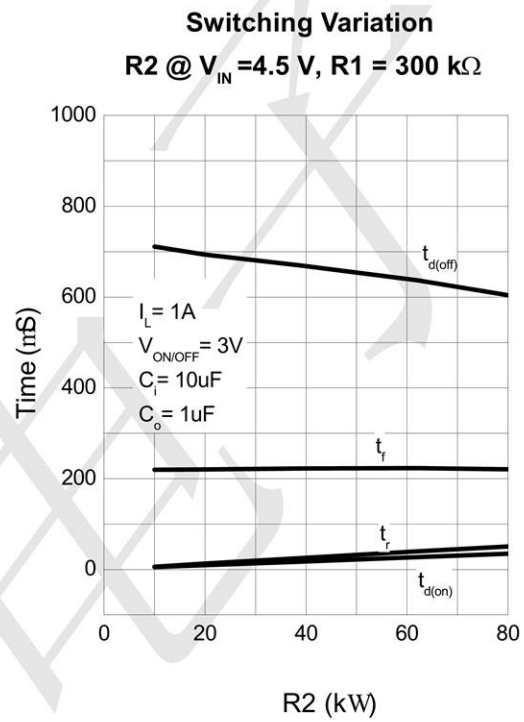
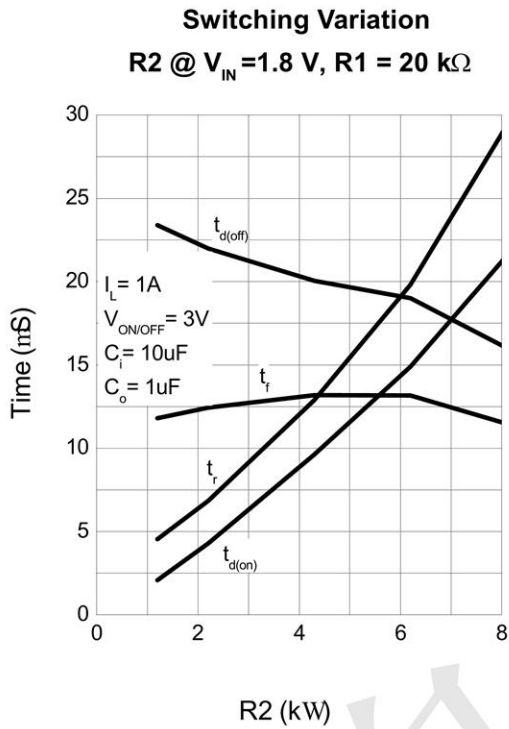



SOT23-6 Package Information

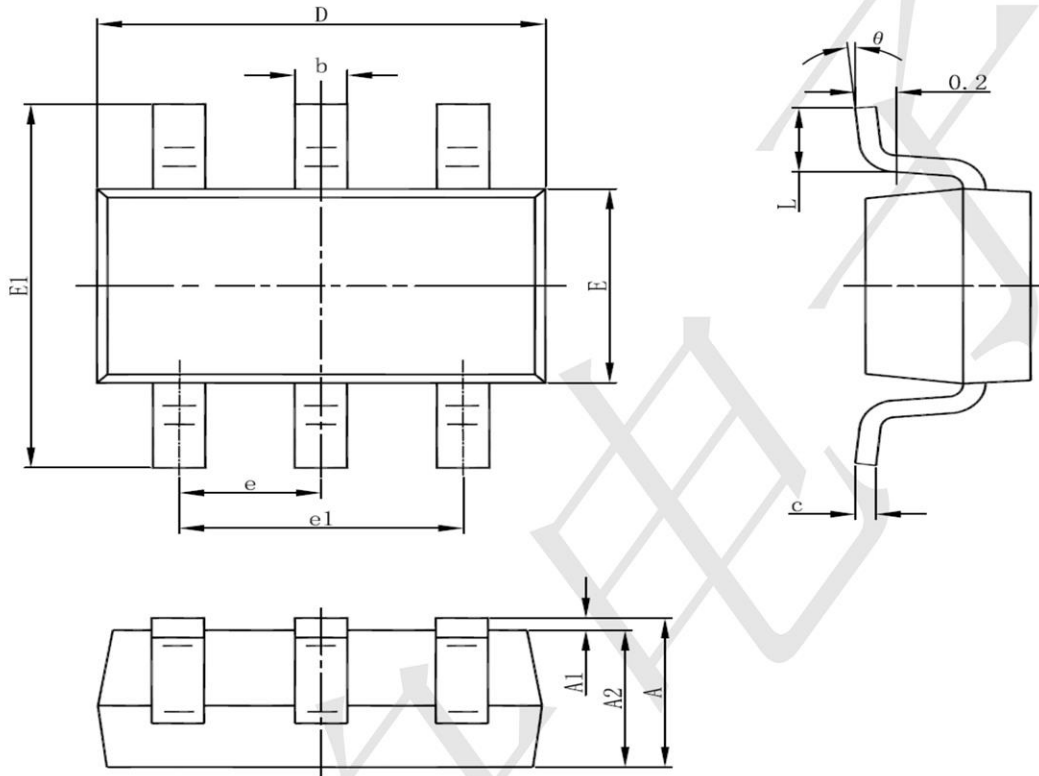

Symbol	Dimensions In Millimeters		Dimensions In Inches	
	Min	Max	Min	Max
A	1.050	1.250	0.041	0.049
A1	0.000	0.100	0.000	0.004
A2	1.050	1.150	0.041	0.045
b	0.300	0.500	0.012	0.020
c	0.100	0.200	0.004	0.008
D	2.820	3.020	0.111	0.119
E	1.500	1.700	0.059	0.067
E1	2.650	2.950	0.104	0.116
e	0.950(BSC)		0.037(BSC)	
e1	1.800	2.000	0.071	0.079
L	0.300	0.600	0.012	0.024
θ	0°	8°	0°	8°