

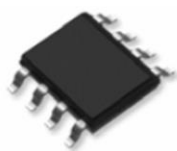
## GENERAL FEATURES

$V_{(BR)DSS}$	-20V
$R_{DS(ON)}$	8.5m $\Omega$
$I_D$	-14A

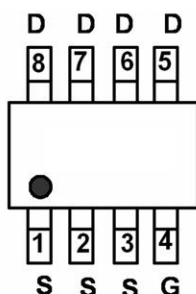
## Application

- PWM Applications
- Load Switch

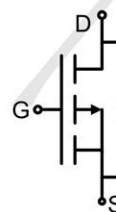
## Package and Pin Configuration



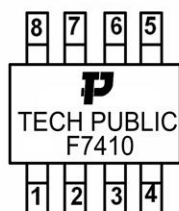
SOP-8 top view



## Circuit diagram



## Marking:



## Absolute Maximum Ratings ( $T_C=25^\circ\text{C}$ unless otherwise specified)

Parameter	Symbol	Rating	Unit
Drain-Source Voltage	$V_{DS}$	-20	V
Gate-Source Voltage	$V_{GS}$	$\pm 12$	V
Drain Current – Continuous ( $T_C=25^\circ\text{C}$ )	$I_D$	-14	A
Drain Current – Continuous ( $T_C=100^\circ\text{C}$ )		-8.8	A
Drain Current – Pulsed <sup>1</sup>	$I_{DM}$	-56	A
Power Dissipation ( $T_C=25^\circ\text{C}$ )	$P_D$	2	W
Power Dissipation – Derate above $25^\circ\text{C}$		0.016	W/ $^\circ\text{C}$
Storage Temperature Range	$T_{STG}$	-55 to +150	$^\circ\text{C}$
Operating Junction Temperature Range	$T_J$	-55 to +150	$^\circ\text{C}$

## Thermal Characteristics

Parameter	Symbol	Typ.	Max.	Unit
Thermal Resistance Junction to Ambient	$R_{\theta JA}$	---	62	$^\circ\text{C}/\text{W}$
Thermal Resistance Junction to Case	$R_{\theta JC}$	---	17	$^\circ\text{C}/\text{W}$

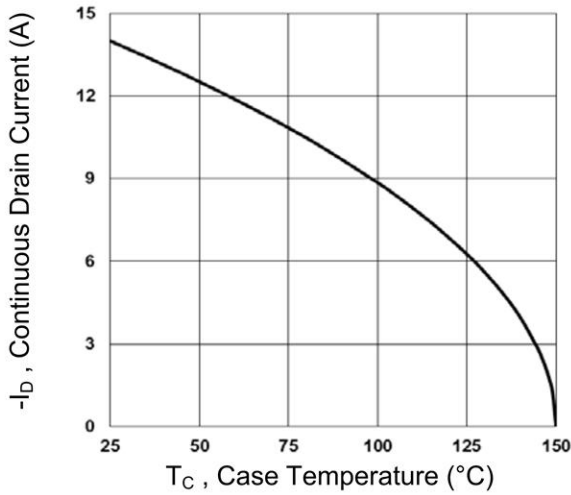
### Electrical Characteristics ( $T_J=25^\circ\text{C}$ unless otherwise specified)

Parameter	Symbol	Conditions	Min.	Typ.	Max.	Unit
<b>Off Characteristics</b>						
Drain-Source Breakdown Voltage	$BV_{DSS}$	$V_{GS}=0V, I_D=-250\mu A$	-20	---	---	V
$BV_{DSS}$ Temperature Coefficient	$\Delta BV_{DSS}/\Delta T_J$	Reference to $25^\circ\text{C}$ , $I_D=-1\text{mA}$	---	-0.01	---	$V/^\circ\text{C}$
Drain-Source Leakage Current	$I_{DSS}$	$V_{DS}=-20V, V_{GS}=0V, T_J=25^\circ\text{C}$	---	---	-1	$\mu A$
		$V_{DS}=-16V, V_{GS}=0V, T_J=125^\circ\text{C}$	---	---	-10	$\mu A$
Gate-Source Leakage Current	$I_{GSS}$	$V_{GS}=\pm 12V, V_{DS}=0V$	---	---	$\pm 100$	nA
<b>On Characteristics</b>						
Static Drain-Source On-Resistance	$R_{DS(on)}$	$V_{GS}=-4.5V, I_D=-8A$	---	6.5	8.5	m $\Omega$
		$V_{GS}=-2.5V, I_D=-5A$	---	9	12	
		$V_{GS}=-1.8V, I_D=-3A$	---	12	17	
Gate Threshold Voltage	$V_{GS(th)}$	$V_{GS}=V_{DS}, I_D=-250\mu A$	-0.3	-0.6	-1	V
Forward Transconductance	$g_{fs}$	$V_{DS}=-10V, I_S=-5A$	---	20	---	S
<b>Dynamic and Switching Characteristics</b>						
Total Gate Charge <sup>2, 3</sup>	$Q_g$	$V_{DS}=-10V, V_{GS}=-4.5V, I_D=-5A$	---	44.4	80	nC
Gate-Source Charge <sup>2, 3</sup>	$Q_{gs}$		---	7.2	14	
Gate-Drain Charge <sup>2, 3</sup>	$Q_{gd}$		---	10.2	20	
Turn-On Delay Time <sup>2, 3</sup>	$T_{d(on)}$	$V_{DD}=-10V, V_{GS}=-4.5V, R_G=25\Omega, I_D=-1A$	---	13.2	26	nS
Rise Time <sup>2, 3</sup>	$T_r$		---	68	120	
Turn-Off Delay Time <sup>2, 3</sup>	$T_{d(off)}$		---	160	320	
Fall Time <sup>2, 3</sup>	$T_f$		---	154	300	
Input Capacitance	$C_{iss}$	$V_{DS}=-15V, V_{GS}=0V, F=1\text{MHz}$	---	4060	8000	pF
Output Capacitance	$C_{oss}$		---	520	1000	
Reverse Transfer Capacitance	$C_{rss}$		---	400	800	
<b>Drain-Source Diode Characteristics and Maximum Ratings</b>						
Continuous Source Current	$I_S$	$V_G=V_D=0V, \text{Force Current}$	---	---	-14	A
Pulsed Source Current	$I_{SM}$		---	---	-28	A
Diode Forward Voltage	$V_{SD}$	$V_{GS}=0V, I_S=-1A, T_J=25^\circ\text{C}$	---	---	-1	V

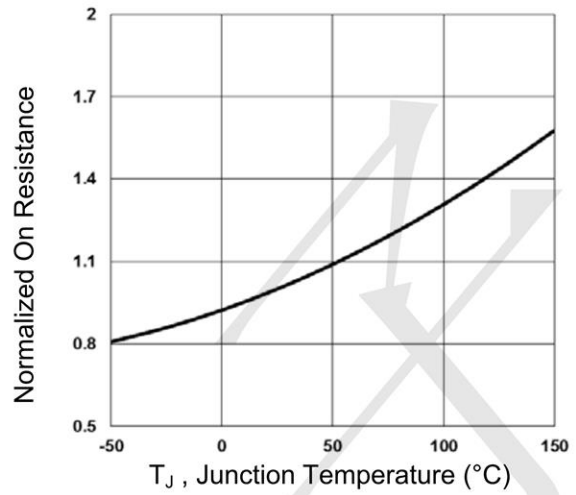
Note:

1. Repetitive Rating: Pulsed width limited by maximum junction temperature.
2. The data tested by pulsed, pulse width  $\leq 300 \mu\text{s}$ , duty cycle  $\leq 2\%$ .
3. Essentially independent of operating temperature.

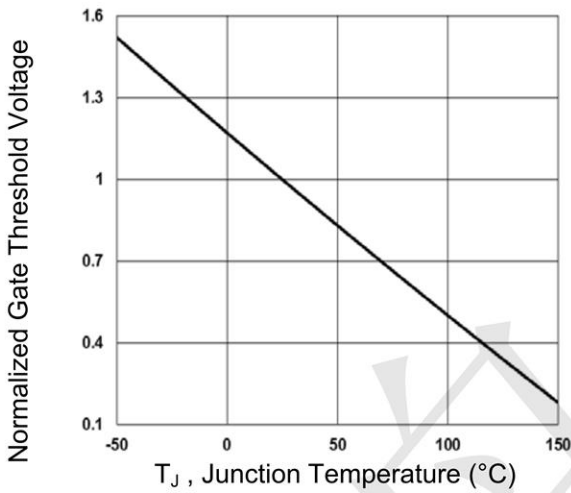
**Typical Electrical and Thermal Characteristic Curves**



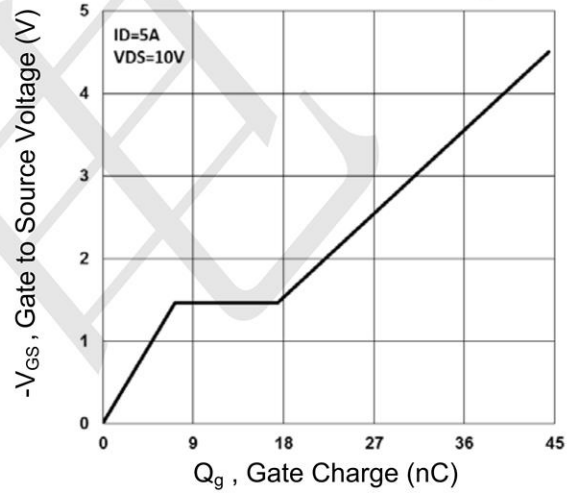
**Fig.1 Continuous Drain Current vs.  $T_c$**



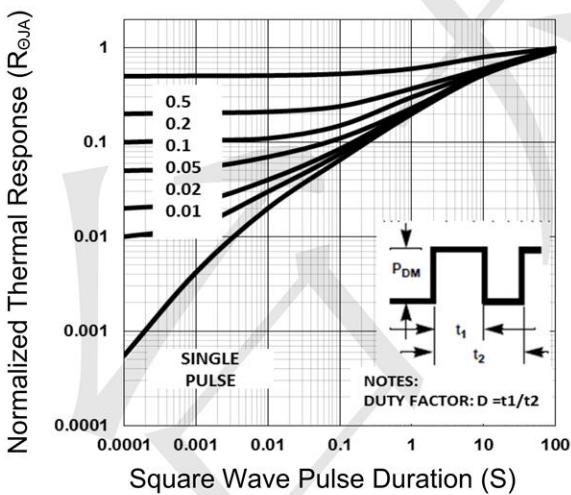
**Fig.2 Normalized  $R_{DS(ON)}$  vs.  $T_j$**



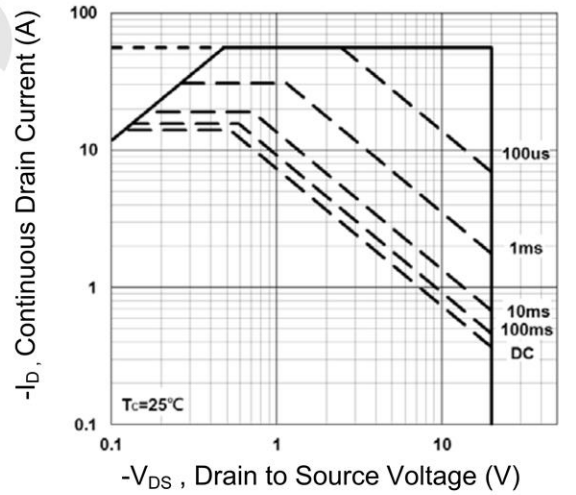
**Fig.3 Normalized  $V_{th}$  vs.  $T_j$**



**Fig.4 Gate Charge Waveform**

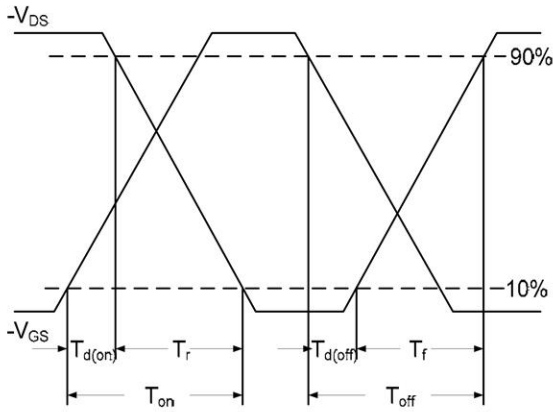


**Fig.5 Normalized Transient Response**

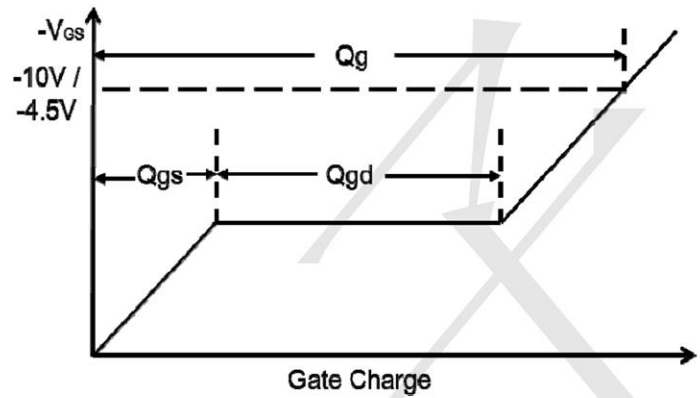


**Fig.6 Maximum Safe Operation Area**

**Typical Electrical and Thermal Characteristic Curves**

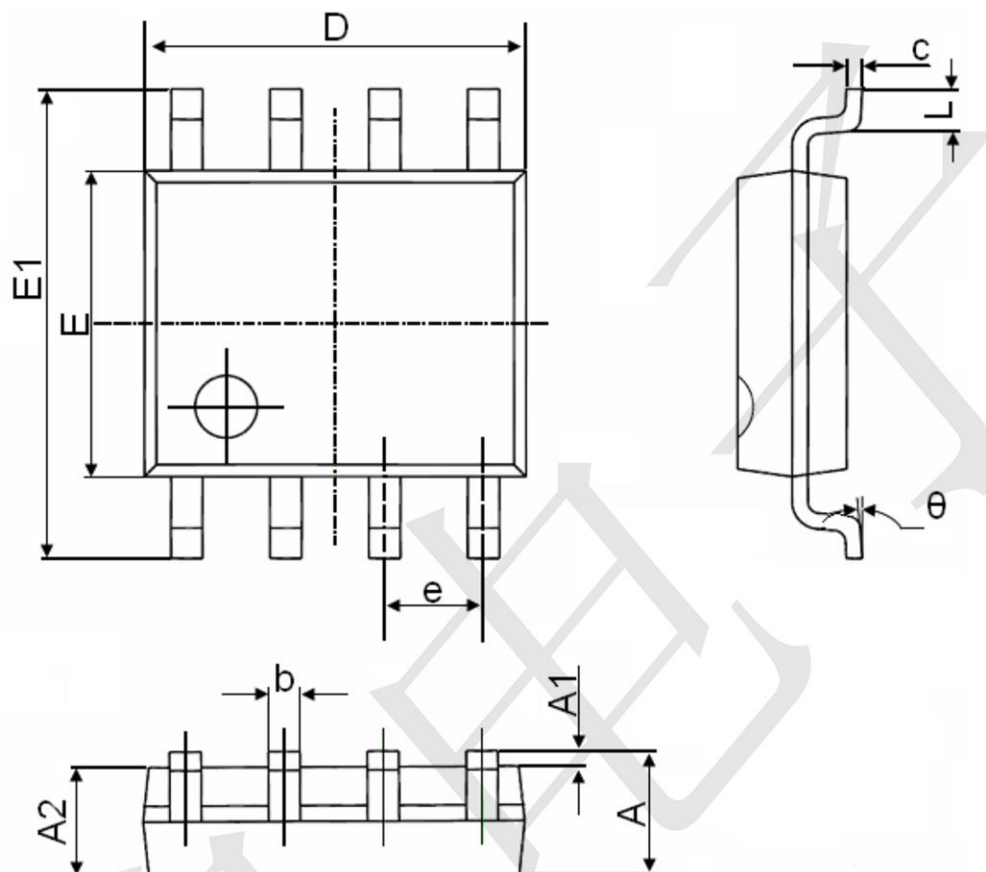


**Fig.7 Switching Time Waveform**



**Fig.8 Gate Charge Waveform**

**SOP-8 Package Information**



Symbol	Dimensions In Millimeters		Dimensions In Inches	
	Min.	Max.	Min.	Max.
A	1.350	1.750	0.053	0.069
A1	0.100	0.250	0.004	0.010
A2	1.350	1.550	0.053	0.061
b	0.330	0.510	0.013	0.020
c	0.170	0.250	0.006	0.010
D	4.700	5.100	0.185	0.200
E	3.800	4.000	0.150	0.157
E1	5.800	6.200	0.228	0.244
e	1.270(BSC)		0.050(BSC)	
L	0.400	1.270	0.016	0.050
θ	0°	8°	0°	8°