



# ST34B THRU ST310B

Reverse Voltage - 40 to 100 Volts Forward Current - 3.0 Ampere

## SURFACE MOUNT TRENCH SCHOTTKY RECTIFIER

### Features

- ◆ The plastic package carries Underwriters Laboratory Flammability Classification 94V-0
- ◆ Metal silicon junction, majority carrier conduction
- ◆ High efficiency operation
- ◆ Ultra low forward voltage drop, low power losses
- ◆ High forward surge current capability
- ◆ High temperature soldering guaranteed:  
260°C/10 seconds, 0.375" (9.5mm) lead length, 5 lbs. (2.3kg) tension

DO-214AA/SMB

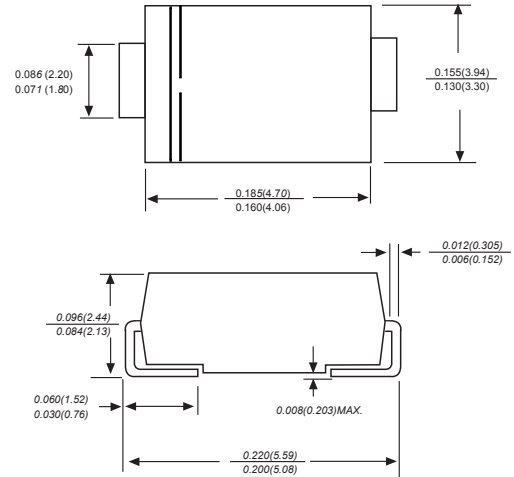

Dimensions in inches and (millimeters)

### Mechanical Data

**Case :** JEDEC DO-214AA/SMB Molded plastic body  
**Terminals :** Solder plated, solderable per MIL-STD-750, Method 2026  
**Polarity :** Polarity symbol marking on body  
**Mounting Position :** Any  
**Weight :** 0.003ounce, 0.093 grams

### Maximum Ratings And Electrical Characteristics

Ratings at 25°C ambient temperature unless otherwise specified.

Single phase half-wave 60Hz, resistive or inductive load, for capacitive load current derate by 20%.

MDD Catalog Number	SYMBOLS	ST34B	ST36B	ST310B	UNITS
Maximum repetitive peak reverse voltage	$V_{RRM}$	40	60	100	V
Maximum RMS voltage	$V_{RMS}$	28	42	70	V
Maximum DC blocking voltage	$V_{DC}$	40	60	100	V
Maximum average forward rectified current 0.375" (9.5mm) lead length (see fig. 1)	$I_{(AV)}$	3.0			A
Peak forward surge current 8.3ms single half sine-wave superimposed on rated load (JEDEC Method)	$I_{FSM}$	80.0	60.0		A
Maximum instantaneous forward voltage at 3.0A	$V_F$	0.41	0.50	0.60	V
Maximum DC reverse current at rated DC blocking voltage	$I_R$	0.10	0.03	0.02	mA
$T_A=25\text{ }^\circ\text{C}$ $T_A=100\text{ }^\circ\text{C}$		20.0		10.0	
Typical junction capacitance (NOTE 1)	$C_J$	500			pF
Typical thermal resistance (NOTE 2)	$R_{\theta JA}$	68			°C/W
Operating junction temperature range	$T_J$	-55 to +125	-55 to +150		°C
Storage temperature range	$T_{STG}$	-55 to +150			°C

**Note:** 1. Measured at 1MHz and applied reverse voltage of 4.0V D.C.

2. Thermal resistance from junction to ambient at 0.375" (9.5mm) lead length, P.C.B. mounted



# ST34B THRU ST310B

Reverse Voltage - 40 to 100 Volts Forward Current - 3.0 Ampere

## Ratings And Characteristic Curves

AVERAGE FORWARD RECTIFIED CURRENT, AMPERES

FIG. 1- FORWARD CURRENT DERATING CURVE

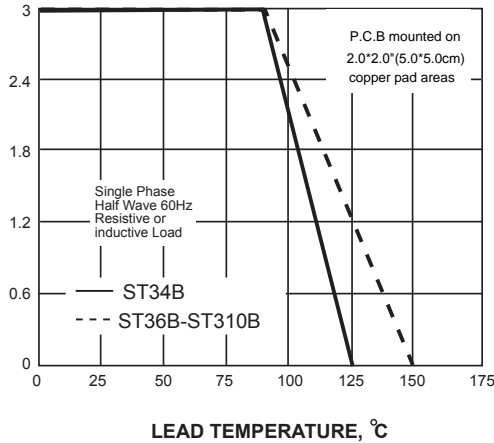

PEAK FORWARD SURGE CURRENT, AMPERES

FIG. 2-MAXIMUM NON-REPETITIVE PEAK FORWARD SURGE CURRENT

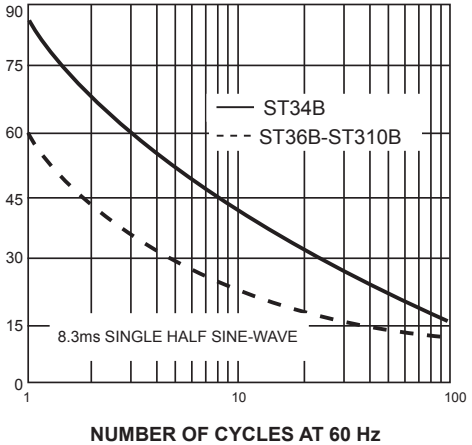
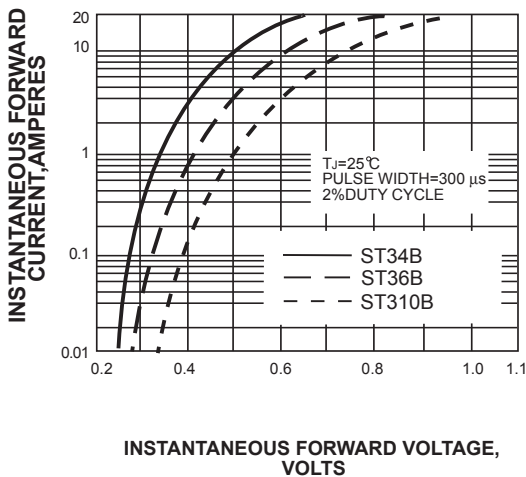

FIG. 3-TYPICAL INSTANTANEOUS FORWARD CHARACTERISTICS



INSTANTANEOUS REVERSE CURRENT, MILLIAMPERES

FIG. 4-TYPICAL REVERSE CHARACTERISTICS

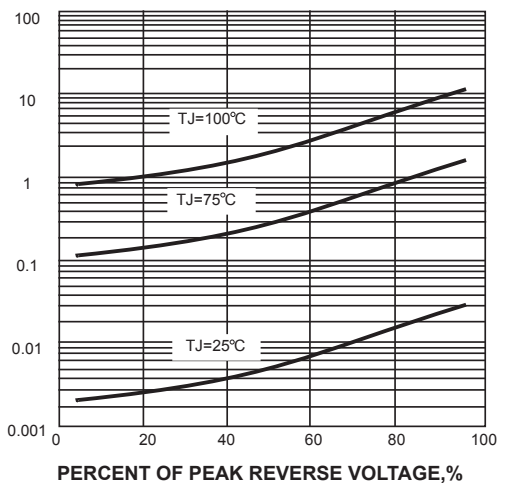
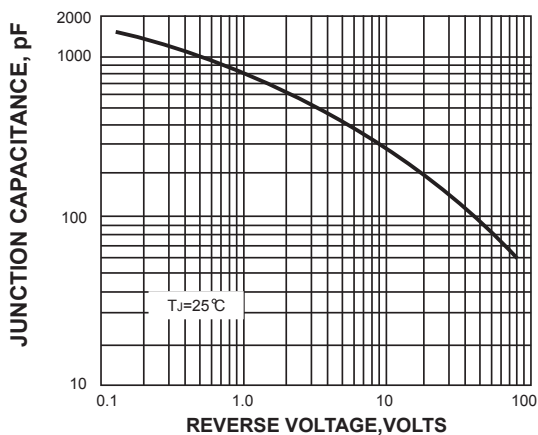
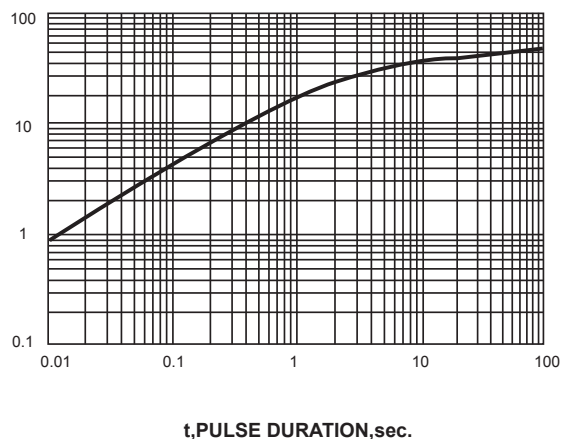

FIG. 5-TYPICAL JUNCTION CAPACITANCE



TRANSIENT THERMAL IMPEDANCE, °C/W

FIG. 6-TYPICAL TRANSIENT THERMAL IMPEDANCE



The curve above is for reference only.



# ST34B THRU ST310B

Reverse Voltage - 40 to 100 Volts Forward Current - 3.0 Ampere

## Packing information

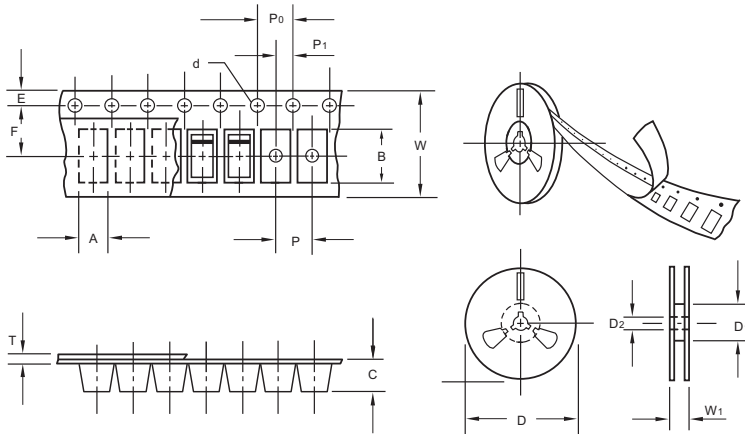

unit:mm

Item	Symbol	Tolerance	SMB
Carrier width	A	0.1	3.81
Carrier length	B	0.1	5.41
Carrier depth	C	0.1	2.42
Sprocket hole	d	0.05	1.5.0
13" Reel outside diameter	D	2.0	330.00
13" Reel inner diameter	D <sub>1</sub>	min	50.00
Feed hole diameter	D <sub>2</sub>	0.5	13.00
Sprocket hole position	E	0.1	1.75
Punch hole position	F	0.1	5.55
Punch hole pitch	P	0.1	8.00
Sprocket hole pitch	P <sub>0</sub>	0.1	4.00
Embossment center	P <sub>1</sub>	0.1	2.00
Overall tape thickness	T	0.1	0.30
Tape width	W	0.3	12.00
Reel width	W <sub>1</sub>	1.0	12.30

Note: Devices are packed in accordance with EIA standard RS-481-A and specifications listed above.

## Reel packing

PACKAGE	REEL SIZE	REEL (pcs)	COMPONENT SPACING (mm)	BOX (pcs)	INNER BOX (mm)	REEL DIA, (mm)	CARTON SIZE (mm)	CARTON (pcs)	APPROX. GROSS WEIGHT (kg)
SMB	13"	3,000	4.0	6,000	190*190*41	330	365*365*360	48,000	14.0

## Suggested Pad Layout



Symbol	Unit (mm)	Unit (inch)
A	2.8	0.110
B	2.4	0.094
C	4.6	0.181
D	2.2	0.086
E	7.0	0.276