



SS52BF THRU SS520BF

Reverse Voltage - 20 to 200 Volts Forward Current - 5.0 Ampere

SURFACE MOUNT SCHOTTKY BARRIER RECTIFIER

Features

- ◆ Metal silicon junction, majority carrier conduction For surface mounted applications
- ◆ Low power loss,high efficiency
- ◆ High forward surge current capability
- ◆ For use in low voltage,high frequency inverters, free wheeling,and polarity protection applatjons

Mechanical Data

Case: JEDEC UT BØ molded plastic body
 Terminals: Solderable per MIL-STD-750,Method 2026Å
 Polarity: Polarity symbol marking on body Mounting
 Position: Any
 Weight : 0.002 ounce, 0.057 grams

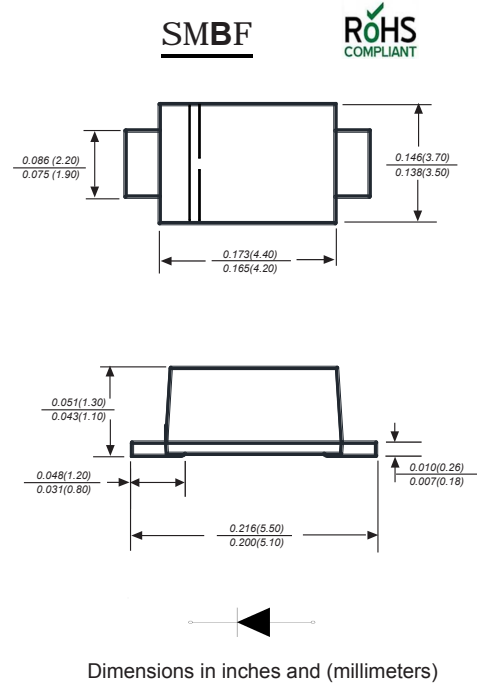

Maximum Ratings And Electrical Characteristics

Ratings at 25°C ambient temperature unless otherwise specified.
 Single phase half-wave 60Hz,resistive or inductive load,for capacitive load current derate by 20%.

Parameter	SYMBOLS	SS52BF	SS53BF	SS54BF	SS55BF	SS56BF	SS58BF	SS510BF	SS515BF	SS520BF	UNITS	
Marking Code		MDD S52B	MDD S53B	MDD S54B	MDD S55B	MDD S56B	MDD S58B	MDD S510B	MDD S515B	MDD S520B		
Maximum repetitive peak reverse voltage	V_{RRM}	20	30	40	50	60	80	100	150	200	V	
Maximum RMS voltage	V_{RMS}	14	21	28	35	42	56	70	105	140	V	
Maximum DC blocking voltage	V_{DC}	20	30	40	50	60	80	100	150	200	V	
Maximum average forward rectified current	$I_{(AV)}$	5.0									A	
Peak forward surge current 8.3ms single half sine-wave superimposed on rated load (JEDEC Method)	I_{FSM}	120									A	
Maximum instantaneous forward voltage at 5.0A	V_F	0.55			0.70		0.85				V	
Maximum DC reverse current $T_A=25^\circ C$ at rated DC blocking voltage $T_A=100^\circ C$	I_R	1.0					50					mA
Typical junction capacitance (NOTE 1)	C_J	800			500						pF	
Typical thermal resistance (NOTE 2)	$R_{\theta JA}$	45									$^\circ C/W$	
Operating junction temperature range	T_J	-55 to +125									$^\circ C$	
Storage temperature range	T_{STG}	-55 to +150									$^\circ C$	

Note:1.Measured at 1MHz and applied reverse voltage of 4.0V D.C.
 2.P.C.B. mounted with 2.0"x2.0" (5.0x5.0cm) copper pad areas



SS52BF THRU SS520BF

Reverse Voltage - 20 to 200 Volts Forward Current - 5.0 Ampere

Typical Characteristics

Fig.1 Forward Current Derating Curve

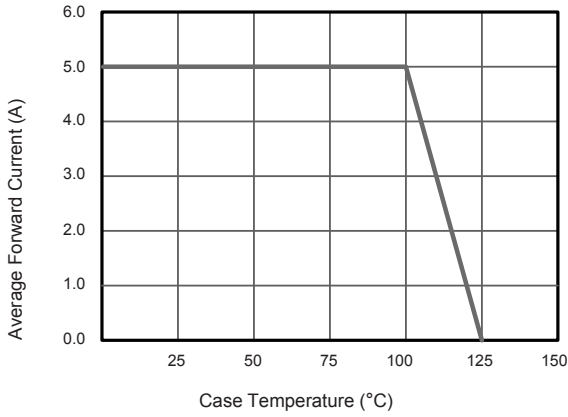

Fig.2 Typical Reverse Characteristics

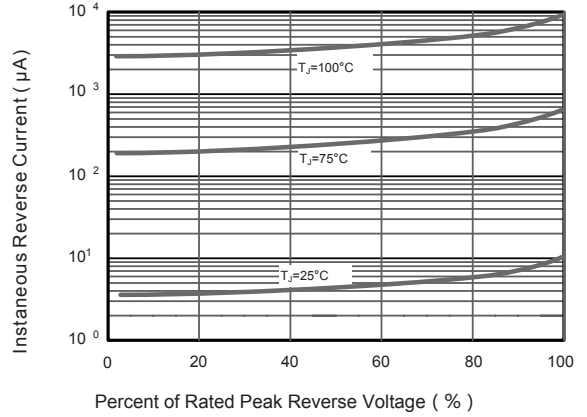

Fig.3 Typical Forward Characteristic

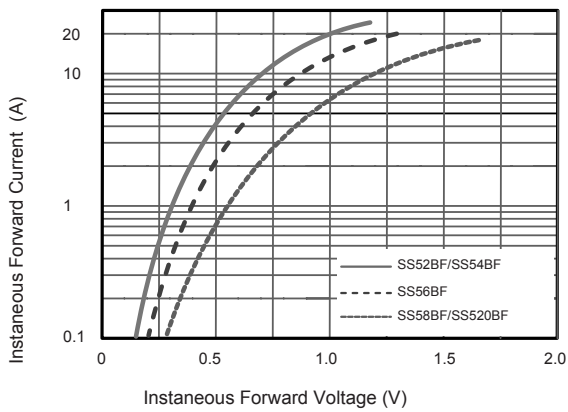

Fig.4 Typical Junction Capacitance

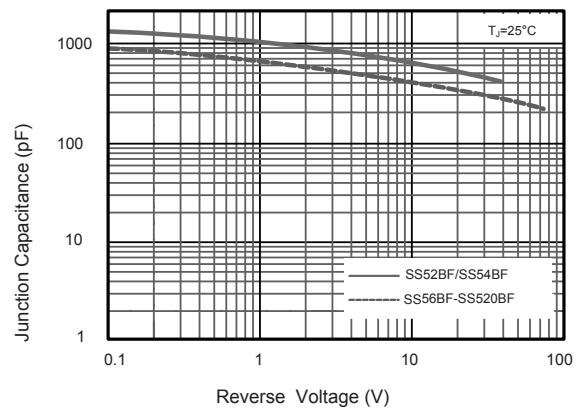

Fig.5 Maximum Non-Repetitive Peak Forward Surge Current

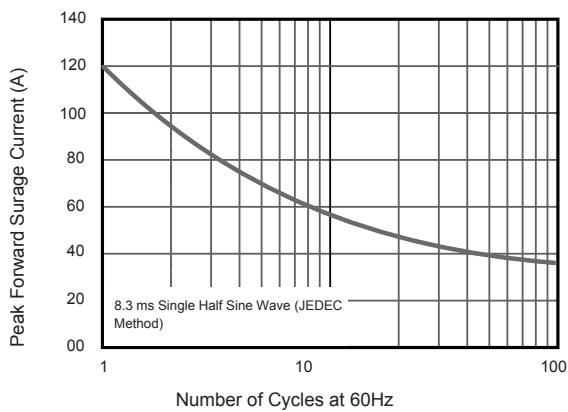
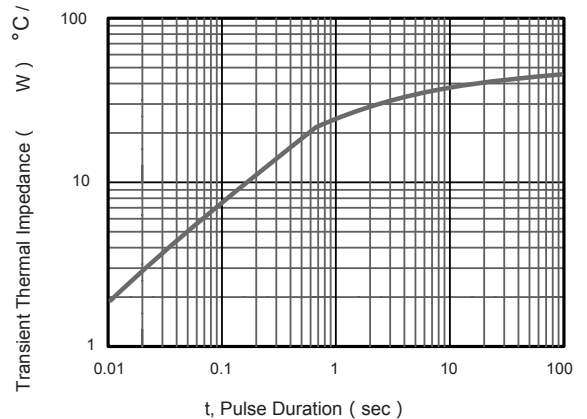

Fig.6- Typical Transient Thermal Impedance



The curve above is for reference only.



SS52BF THRU SS520BF

Reverse Voltage - 20 to 200 Volts Forward Current - 5.0 Ampere

Packing information

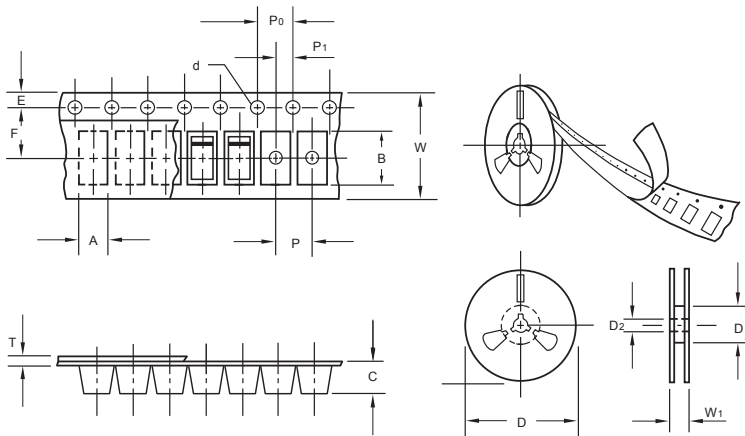

unit:mm

Item	Symbol	Tolerance	SMBF
Carrier width	A	0.1	3.81
Carrier length	B	0.1	5.61
Carrier depth	C	0.1	1.60
Sprocket hole	d	0.05	1.50
13" Reel outside diameter	D	2.0	330.00
13" Reel inner diameter	D ₁	min	50.00
Feed hole diameter	D ₂	0.5	13.00
Sprocket hole position	E	0.1	1.75
Punch hole position	F	0.1	5.50
Punch hole pitch	P	0.1	4.00
Sprocket hole pitch	P ₀	0.1	4.00
Embossment center	P ₁	0.1	2.00
Overall tape thickness	T	0.1	0.30
Tape width	W	0.3	12.00
Reel width	W ₁	1.0	12.30

Note: Devices are packed in accordance with EIA standard RS-481-A and specifications listed above.

Reel packing

PACKAGE	REEL SIZE	REEL (pcs)	COMPONENT SPACING (mm)	BOX (pcs)	INNER BOX (mm)	REEL DIA. (mm)	CARTON SIZE (mm)	CARTON (pcs)	APPROX. GROSS WEIGHT (kg)
SMBF	13"	5,000	4.0	10,000	190*190*41	330	365*365*360	80,000	14.0

Suggested Pad Layout

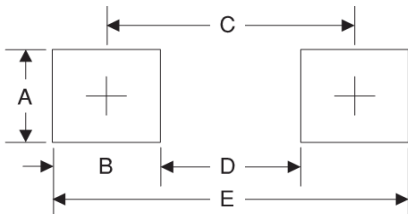

Symbol	Unit (mm)	Unit (inch)
A	2.54	0.100
B	1.8	0.071
C	4.8	0.189
D	3.0	0.118
E	6.6	0.260