

# RS4G126 Quadruple Bus Buffer Gate With 3-State Outputs

## FEATURES

- **Operating Voltage Range: 1.65V to 5.5V**
- **Low Power Consumption: 1μA (Max)**
- **Operating Temperature Range: -40°C to +125°C**
- **Inputs Accept Voltage to 5.5V**
- **±24mA Output Drive at V<sub>CC</sub>=3.0V**
- **Latch-up Performance Exceeds 100mA**
- **PACKAGES: SOIC-14(SOP14) and TSSOP-14**

## APPLICATIONS

- **AV Receiver**
- **Cable Modem Termination Systems**
- **Digital Picture Frame (DPF)**
- **High-Speed Data Acquisition and Generation**
- **Motor Controls: High-Voltage**
- **Personal Navigation Device (GPS)**
- **Portable Media Player**
- **Video Communication Systems**

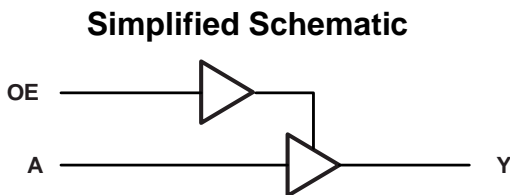

## DESCRIPTION

The quadruple buffer is designed for 1.65V to 5.5V V<sub>CC</sub> operation. The RS4G126 device is quadruple line drivers with 3-state outputs. The outputs are disabled when the output-enable input is low.

This device is fully specified for partial-power-down applications using I<sub>off</sub>. The I<sub>off</sub> circuitry disables the outputs, preventing damaging current backflow through the device when it is powered down.

To ensure the high-impedance state during power up or power down, OE should be tied to GND through a pull-down resistor, the minimum value of the resistor is determined by the current-sourcing capability of the driver.

The RS4G126 is available in Green SOIC-14(SOP14) and TSSOP-14 packages. It operates over an ambient temperature range of -40°C to +125°C.

### Device Information (1)

PART NUMBER	PACKAGE	BODY SIZE (NOM)
RS4G126	SOIC-14(SOP14)	8.65mm×3.90mm
	TSSOP-14	5.00mm×4.40mm

(1) For all available packages, see the orderable addendum at the end of the data sheet.

### FUNCTION TABLE

INPUTS		OUTPUT
OE	A	Y
H	H	H
H	L	L
L	X	Z

H=HIGH Logic Level  
 L =LOW Logic Level  
 X=Don't Care  
 Z=High-impedance OFF-state

## Revision History

Note: Page numbers for previous revisions may differ from page numbers in the current version.

Version	Change Date	Change Item
A.1	2021/02/05	Initial version completed
A.2	2021/12/22	Added the TAPE AND REEL INFORMATION

## PIN CONFIGURATIONS

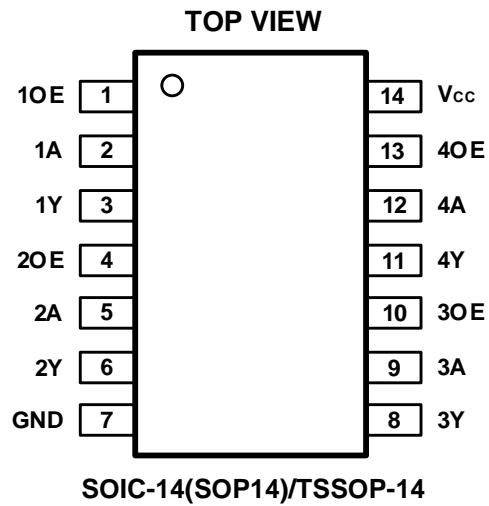

## PIN DESCRIPTION

PIN	NAME	I/O TYPE	FUNCTION
SOIC-14(SOP14)/TSSOP-14			
1	10E	I	Output Enable for buffer 1
2	1A	I	Input of buffer 1
3	1Y	O	Output of buffer 1
4	20E	I	Output Enable for buffer 2
5	2A	I	Input of buffer 2
6	2Y	O	Output of buffer 2
7	GND	-	Ground
8	3Y	O	Output of buffer 3
9	3A	I	Input of buffer 3
10	30E	I	Output Enable for buffer 3
11	4Y	O	Output of buffer 4
12	4A	I	Input of buffer 4
13	40E	I	Output Enable for buffer 4
14	V <sub>cc</sub>	-	Power Supply

## Specifications

### Absolute Maximum Ratings <sup>(1)</sup>

over operating free-air temperature range (unless otherwise noted) <sup>(1)</sup> <sup>(2)</sup>

		MIN	MAX	UNIT
V <sub>CC</sub>	Supply voltage range	-0.5	6.5	V
V <sub>I</sub>	Input voltage range <sup>(2)</sup>	-0.5	6.5	V
V <sub>O</sub>	Voltage range applied to any output in the high-impedance or power-off state <sup>(2)</sup>	-0.5	6.5	V
V <sub>O</sub>	Voltage range applied to any output in the high or low state <sup>(2)</sup> <sup>(3)</sup>	-0.5	V <sub>CC</sub> +0.5	V
I <sub>IK</sub>	Input clamp current	V <sub>I</sub> <0	-50	mA
I <sub>OK</sub>	Output clamp current	V <sub>O</sub> <0	-50	mA
I <sub>O</sub>	Continuous output current		±50	mA
	Continuous current through V <sub>CC</sub> or GND		±100	mA
T <sub>J</sub>	Junction temperature	-65	150	°C
T <sub>stg</sub>	Storage temperature	-65	150	°C

(1) Stresses beyond those listed under *Absolute Maximum Ratings* may cause permanent damage to the device. These are stress ratings only, and functional operation of the device at these or any other conditions beyond those indicated under *Recommended Operating Conditions* is not implied. Exposure to absolute-maximum-rated conditions for extended periods may affect device reliability.

(2) The input and output negative-voltage ratings may be exceeded if the input and output current ratings are observed.

(3) The value of V<sub>CC</sub> is provided in the *Recommended Operating Conditions table*.

### ESD Ratings

		VALUE	UNIT	
V <sub>(ESD)</sub>	Electrostatic discharge	Human-body model (HBM)	±8000	V
		Machine model (MM)	±500	V

### Thermal Information:

THERMAL METRIC		RS4G126		UNIT
		14PINS		
		SOIC-14(SOP14)	TSSOP-14	
R <sub>θJA</sub>	Junction-to-ambient thermal resistance	122.2	141.2	°C/W
R <sub>θJC(top)</sub>	Junction-to-case(top) thermal resistance	80.9	78.8	°C/W
R <sub>θJB</sub>	Junction-to-board thermal resistance	80.6	85.8	°C/W
Ψ <sub>JT</sub>	Junction-to-top characterization parameter	40.4	27.7	°C/W
Ψ <sub>JB</sub>	Junction-to-board characterization parameter	80.3	85.5	°C/W
R <sub>θJC(bot)</sub>	Junction-to-case(bottom) thermal resistance	N/A	N/A	°C/W

**PACKAGE/ORDERING INFORMATION**

PRODUCT	ORDERING NUMBER	TEMPERATURE RANGE	PACKAGE LEAD	PACKAGE MARKING <sup>(1)</sup>	PACKAGE OPTION
RS4G126	RS4G126XP	-40°C ~+125°C	SOIC-14(SOP14)	RS4G126	Tape and Reel,4000
	RS4G126XQ	-40°C ~+125°C	TSSOP-14	RS4G126	Tape and Reel,4000

NOTE:

- (1) There may be additional marking, which relates to the lot trace code information (data code and vendor code), the logo or the environmental category on the device.

## ELECTRICAL CHARACTERISTICS

over recommended operating free-air temperature range (TYP values are at  $T_A = +25^\circ\text{C}$ , unless otherwise noted.) <sup>(1)</sup>

### Recommended Operating Conditions

PARAMETER	SYMBOL	TEST CONDITIONS	MIN	MAX	UNIT
Supply voltage	$V_{CC}$	Operating	1.65	5.5	V
		Data retention only	1.5	5.5	
High-level input voltage	$V_{IH}$	$V_{CC}=1.65\text{V to }1.95\text{V}$	$0.65 \times V_{CC}$		V
		$V_{CC}=2.3\text{V to }2.7\text{V}$	1.7		
		$V_{CC}=3\text{V to }3.6\text{V}$	2.2		
		$V_{CC}=4.5\text{V to }5.5\text{V}$	$0.7 \times V_{CC}$		
Low-level input voltage	$V_{IL}$	$V_{CC}=1.65\text{V to }1.95\text{V}$		$0.15 \times V_{CC}$	V
		$V_{CC}=2.3\text{V to }2.7\text{V}$		0.3	
		$V_{CC}=3\text{V to }3.6\text{V}$		0.4	
		$V_{CC}=4.5\text{V to }5.5\text{V}$		$0.15 \times V_{CC}$	
Input voltage	$V_I$		0	5.5	V
Output voltage	$V_O$		0	$V_{CC}$	V
Input transition rise or fall	$t_r, t_f$	$V_{CC}=1.8\text{V} \pm 0.15\text{V}, 2.5\text{V} \pm 0.2\text{V}$		20	ns/V
		$V_{CC}=3.3\text{V} \pm 0.3\text{V}$		10	
		$V_{CC}=5\text{V} \pm 0.5\text{V}$		5	
Operating temperature	$T_A$		-40	+125	$^\circ\text{C}$

### DC Characteristics

PARAMETER	TEST CONDITIONS	$V_{CC}$	TEMP	MIN	TYP	MAX	UNIT	
$V_{OH}$	$I_{OH} = -100\mu\text{A}$	1.65V to 5.5V	Full	$V_{CC}-0.1$			V	
	$I_{OH} = -4\text{mA}$	1.65V		1.2				
	$I_{OH} = -8\text{mA}$	2.3V		1.9				
	$I_{OH} = -16\text{mA}$	3V		2.4				
	$I_{OH} = -24\text{mA}$			2.3				
	$I_{OH} = -32\text{mA}$	4.5V		3.8				
$V_{OL}$	$I_{OL} = 100\mu\text{A}$	1.65V to 5.5V	Full			0.1	V	
	$I_{OL} = 4\text{mA}$	1.65V				0.45		
	$I_{OL} = 8\text{mA}$	2.3V				0.3		
	$I_{OL} = 16\text{mA}$	3V				0.4		
	$I_{OL} = 24\text{mA}$					0.55		
	$I_{OL} = 32\text{mA}$	4.5V				0.55		
$I_I$	A or OE inputs	$V_I=5.5\text{V or GND}$	0V to 5.5V	+25 $^\circ\text{C}$		$\pm 0.1$	$\pm 1$	$\mu\text{A}$
				Full			$\pm 5$	
$I_{off}$		$V_I \text{ or } V_O=5.5\text{V}$	0V	+25 $^\circ\text{C}$		$\pm 0.1$	$\pm 1$	$\mu\text{A}$
				Full			$\pm 10$	
$I_{OZ}$	$V_O=0\text{V to }5.5\text{V}$	3.6V	Full			10	$\mu\text{A}$	
$I_{CC}$	$V_I=5.5\text{V or GND, } I_O=0$	1.65V to 5.5V	+25 $^\circ\text{C}$		0.1	1	$\mu\text{A}$	
			Full			10		
$\Delta I_{CC}$	One input at $V_{CC}-0.6\text{V}$ , Other inputs at $V_{CC}$ or GND	3V to 5.5V	Full			500	$\mu\text{A}$	

**Switching Characteristics,  $C_L=15\text{pF}$** 

 over recommended operating free-air temperature range (-40°C to 125°C, unless otherwise noted.) <sup>(1)</sup>

PARAMETER	FROM (INPUT)	TO (OUTPUT)	$V_{CC}=1.8\text{V}\pm 0.15\text{V}$	$V_{CC}=2.5\text{V}\pm 0.2\text{V}$	$V_{CC}=3.3\text{V}\pm 0.3\text{V}$	$V_{CC}=5\text{V}\pm 0.5\text{V}$	UNIT
			TYP	TYP	TYP	TYP	
$t_{pd}$	A	Y	6.1	3.7	3.9	2.1	ns

**Switching Characteristics,  $C_L=30\text{pF}$  or  $50\text{pF}$** 

 over recommended operating free-air temperature range (-40°C to 125°C, unless otherwise noted.) <sup>(1)</sup>

PARAMETER	FROM (INPUT)	TO (OUTPUT)	$V_{CC}=1.8\text{V}\pm 0.15\text{V}$	$V_{CC}=2.5\text{V}\pm 0.2\text{V}$	$V_{CC}=3.3\text{V}\pm 0.3\text{V}$	$V_{CC}=5\text{V}\pm 0.5\text{V}$	UNIT
			TYP	TYP	TYP	TYP	
$t_{pd}$	A	Y	8.6	5.3	4.0	2.9	ns
$t_{en}$	OE	Y	9.5	5.8	5.0	3.3	ns
$t_{dis}$	OE	Y	7.4	4.3	4.4	3.0	ns

**Operating Characteristics**
 $T_A=25^\circ\text{C}$ 

PARAMETER			TEST CONDITIONS	$V_{CC}=1.8\text{V}$	$V_{CC}=2.5\text{V}$	$V_{CC}=3.3\text{V}$	$V_{CC}=5\text{V}$	UNIT
				TYP	TYP	TYP	TYP	
$C_{pd}$	Power dissipation capacitance	Output enabled	$f=10\text{MHz}$	18	18	18	21	pF
		Output disabled		2	2	3	4	

 (1) All unused inputs of the device must be held at  $V_{CC}$  or GND to ensure proper device operation.

## Parameter Measurement Information

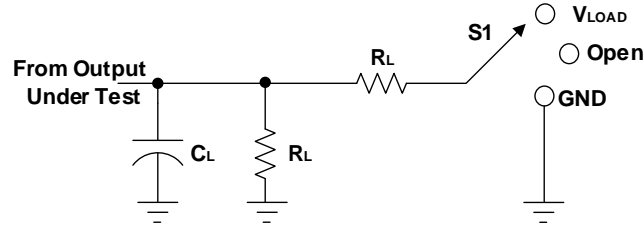

TEST	S1
$t_{PLH}/t_{PHL}$	Open
$t_{PLZ}/t_{PZL}$	$V_{LOAD}$
$t_{PHZ}/t_{PZH}$	GND

$V_{CC}$	INPUTS		$V_M$	$V_{LOAD}$	CL		RL		$V_{\Delta}$
	$V_I$	$t_r/t_f$							
$1.8V \pm 0.15V$	$V_{CC}$	$\leq 2ns$	$V_{CC}/2$	$2 \times V_{CC}$	15pF	30pF	1M $\Omega$	1k $\Omega$	0.15V
$2.5V \pm 0.2V$	$V_{CC}$	$\leq 2ns$	$V_{CC}/2$	$2 \times V_{CC}$	15pF	30pF	1M $\Omega$	500 $\Omega$	0.15V
$3.3V \pm 0.3V$	3V	$\leq 2.5ns$	1.5V	6V	15pF	50pF	1M $\Omega$	500 $\Omega$	0.3V
$5V \pm 0.5V$	$V_{CC}$	$\leq 2.5ns$	$V_{CC}/2$	$2 \times V_{CC}$	15pF	50pF	1M $\Omega$	500 $\Omega$	0.3V

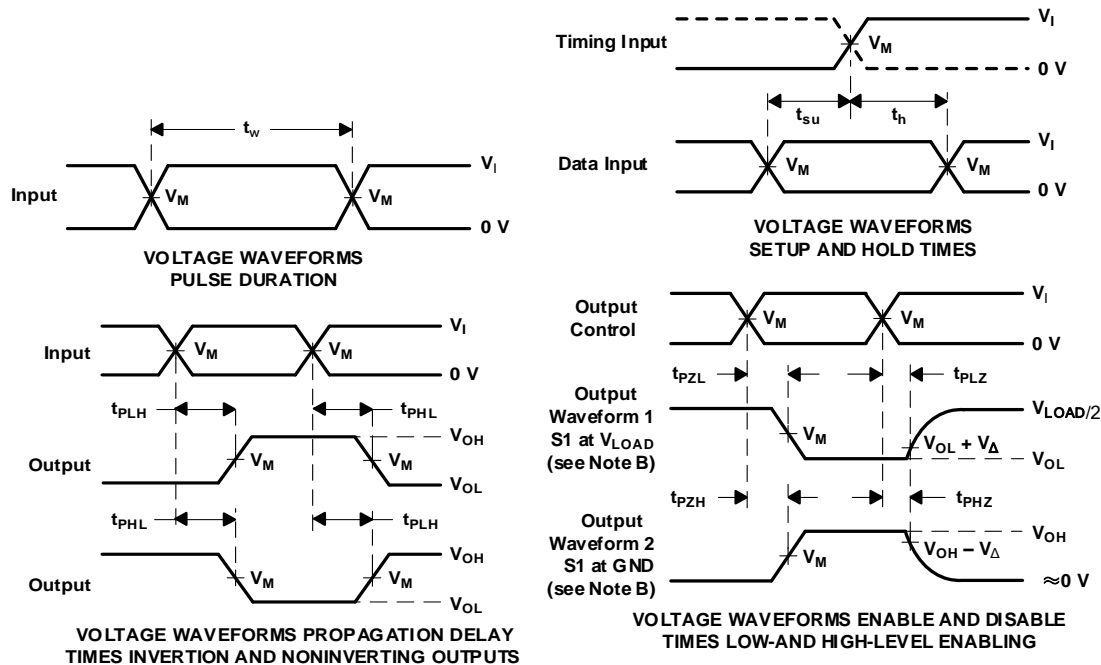

- NOTES: A.  $C_L$  includes probe and jig capacitance.  
 B. Waveform 1 is for an output with internal conditions such that the output is low, except when disabled by the output control. Waveform 2 is for an output with internal conditions such that the output is high, except when disabled by the output control.  
 C. All input pulses are supplied by generators having the following characteristics: PRR  $\leq$  10 MHz,  $Z_o = 50 \Omega$ .  
 D. The outputs are measured one at a time, with one transition per measurement.  
 E.  $t_{PLZ}$  and  $t_{PHZ}$  are the same as  $t_{dis}$ .  
 F.  $t_{PZL}$  and  $t_{PZH}$  are the same as  $t_{en}$ .  
 G.  $t_{PLH}$  and  $t_{PHL}$  are the same as  $t_{pd}$ .  
 H. All parameters and waveforms are not applicable to all devices.

**Figure 1. Load Circuit and Voltage Waveforms**



# PACKAGE OUTLINE DIMENSIONS

## SOIC-14(SOP14)

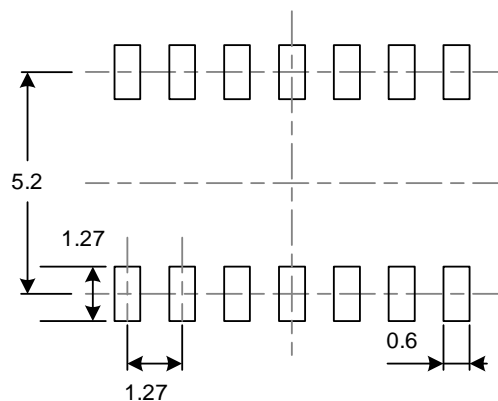
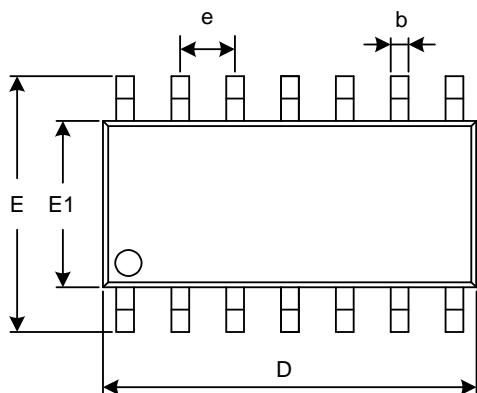

RECOMMENDED LAND PATTERN (Unit: mm)

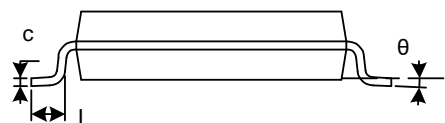
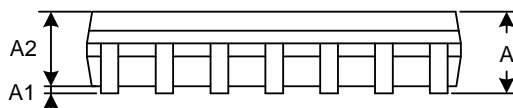

Symbol	Dimensions In Millimeters		Dimensions In Inches	
	Min	Max	Min	Max
A	1.350	1.750	0.053	0.069
A1	0.100	0.250	0.004	0.010
A2	1.350	1.550	0.053	0.061
b	0.310	0.510	0.012	0.020
c	0.100	0.250	0.004	0.010
D	8.450	8.850	0.333	0.348
e	1.270(BSC)		0.050(BSC)	
E	5.800	6.200	0.228	0.244
E1	3.800	4.000	0.150	0.157
L	0.400	1.270	0.016	0.050
$\theta$	0°	8°	0°	8°

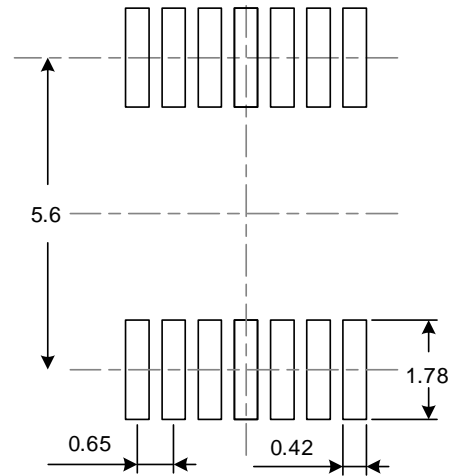
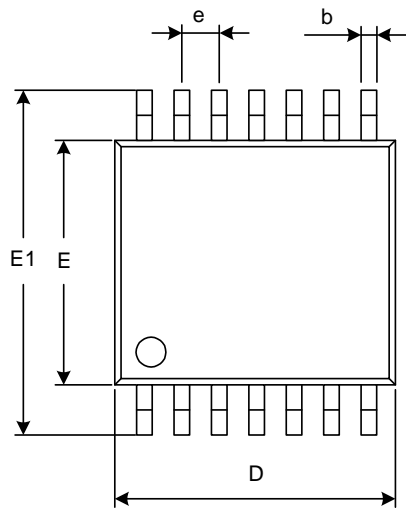
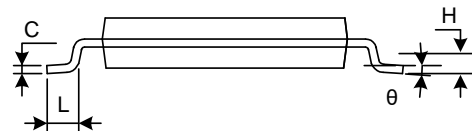
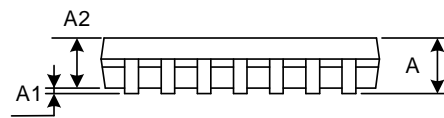
**TSSOP-14**

**RECOMMENDED LAND PATTERN (Unit: mm)**

Symbol	Dimensions In Millimeters		Dimensions In Inches	
	Min	Max	Min	Max
A		1.200		0.047
A1	0.050	0.150	0.002	0.006
A2	0.800	1.050	0.031	0.041
b	0.190	0.300	0.007	0.012
c	0.090	0.200	0.004	0.008
D	4.860	5.100	0.191	0.201
E	4.300	4.500	0.169	0.177
E1	6.250	6.550	0.246	0.258
e	0.650(BSC)		0.026(BSC)	
L	0.500	0.700	0.020	0.028
H	0.25(TYP)		0.01(TYP)	
$\theta$	1°	7°	1°	7°

## TAPE AND REEL INFORMATION

### REEL DIMENSIONS

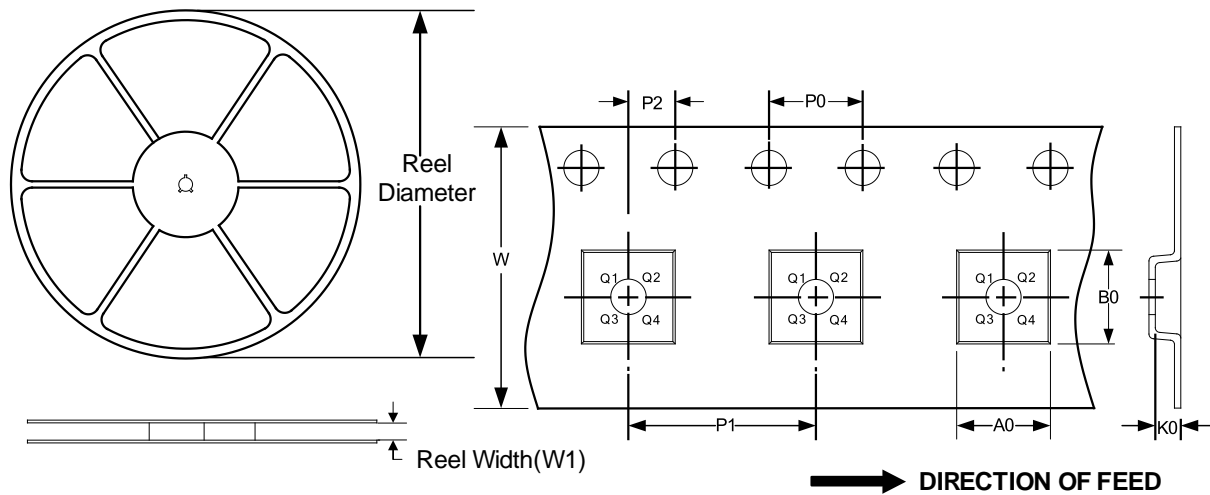
### TAPE DIMENSION



NOTE: The picture is only for reference. Please make the object as the standard.

### KEY PARAMETER LIST OF TAPE AND REEL

Package Type	Reel Diameter	Reel Width(mm)	A0 (mm)	B0 (mm)	K0 (mm)	P0 (mm)	P1 (mm)	P2 (mm)	W (mm)	Pin1 Quadrant
SOIC-14(SOP14)	13"	16.4	6.60	9.30	2.10	4.0	8.0	2.0	16.0	Q1
TSSOP-14	13"	12.4	6.95	5.60	1.20	4.0	8.0	2.0	12.0	Q1