



# S2A THRU S2M

Reverse Voltage - 50 to 1000 Volts Forward Current - 2.0 Ampere

## SURFACE MOUNT GENERAL RECTIFIER

### Features

- ◆ The plastic package carries Underwriters Laboratory Flammability Classification 94V-0
- ◆ Idea for printed circuit board
- ◆ Open Junction chip
- ◆ Low reverse leakage
- ◆ High forward surge current capability
- ◆ High temperature soldering guaranteed  
250 °C/10 seconds at terminals

DO-214AC/SMA

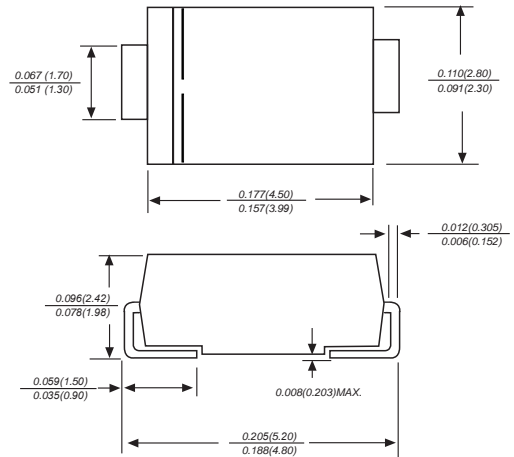

Dimensions in inches and (millimeters)

### Mechanical Data

**Case :** JEDEC DO-214AC/SMA Molded plastic body

**Terminals :** Solder plated, solderable per MIL-STD-750, Method 2026

**Polarity :** Polarity symbol marking on body

**Mounting Position :** Any

**Weight :** 0.0019 ounce, 0.055 grams

### Maximum Ratings And Electrical Characteristics

Ratings at 25°C ambient temperature unless otherwise specified.

Single phase half-wave 60Hz, resistive or inductive load, for capacitive load current derate by 20%.

Parameter	SYMBOLS	MDD S2A	MDD S2B	MDD S2D	MDD S2G	MDD S2J	MDD S2K	MDD S2M	UNITS
Marking Code									
Maximum repetitive peak reverse voltage	V <sub>RRM</sub>	50	100	200	400	600	800	1000	V
Maximum RMS voltage	V <sub>RMS</sub>	35	70	140	280	420	560	700	V
Maximum DC blocking voltage	V <sub>DC</sub>	50	100	200	400	600	800	1000	V
Maximum average forward rectified current at TL=110 °C	I <sub>(AV)</sub>	2.0							A
Peak forward surge current 8.3ms single half sine-wave superimposed on rated load (JEDEC Method)	I <sub>FSM</sub>	50							A
Maximum instantaneous forward voltage at 2.0A	V <sub>F</sub>	1.10							V
Maximum DC reverse current at rated DC blocking voltage T <sub>A</sub> =25°C T <sub>A</sub> =125°C	I <sub>R</sub>	5.0 100							uA
Typical junction capacitance (NOTE 1)	C <sub>J</sub>	25.0							pF
Typical thermal resistance (NOTE 2)	R <sub>θJA</sub>	65.0							°C/W
Operating junction and storage temperature range	T <sub>J</sub> , T <sub>STG</sub>	-55 to +150							°C

**Note:** 1. Measured at 1MHz and applied reverse voltage of 4.0V D.C.  
2. P.C.B. mounted with 2.0"x2.0" (5.0x5.0cm) copper pad areas



# S2A THRU S2M

Reverse Voltage - 50 to 1000 Volts Forward Current - 2.0 Ampere

## Ratings And Characteristic Curves

Fig.1 Forward Current Derating Curve

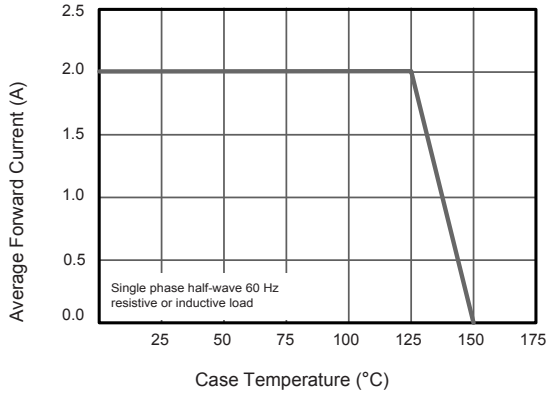

Fig.2 Typical Reverse Characteristics

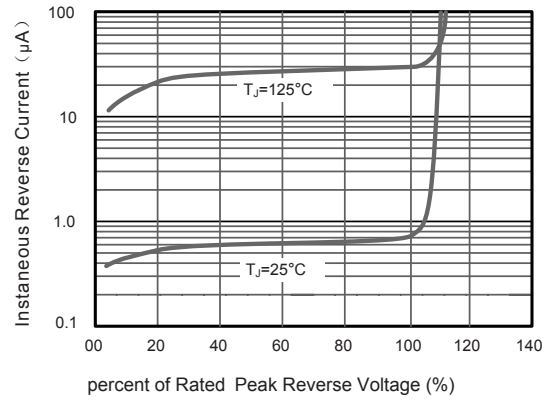

Fig.3 Typical Forward Characteristic

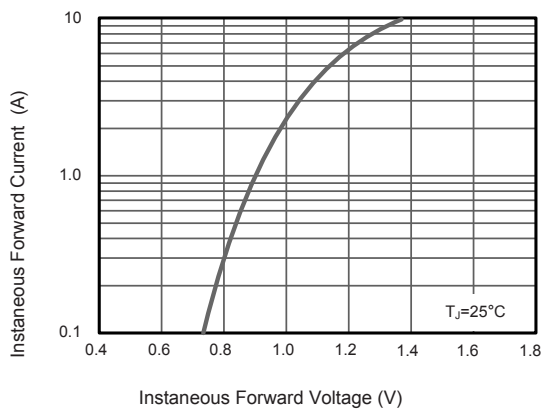

Fig.4 Typical Junction Capacitance

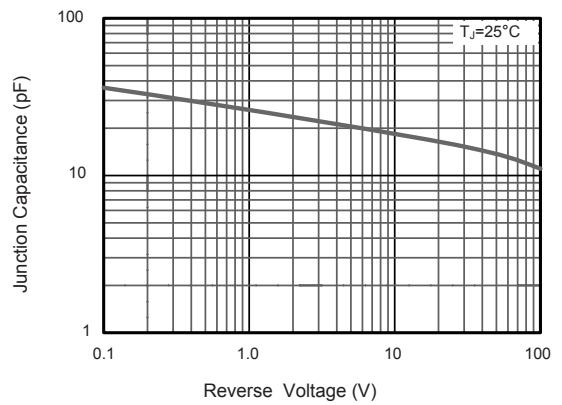
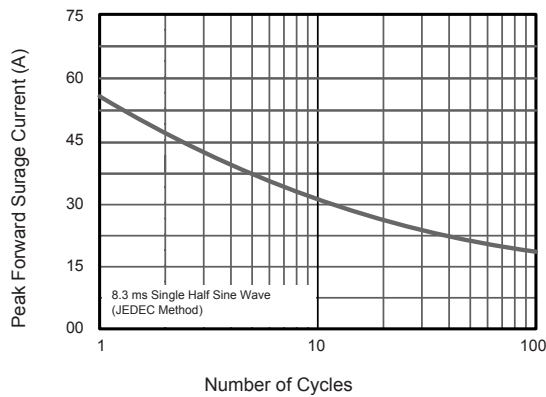

Fig.5 Maximum Non-Repetitive Peak Forward Surge Current



The curve above is for reference only.



# S2A THRU S2M

Reverse Voltage - 50 to 1000 Volts Forward Current - 2.0 Ampere

## Packing information

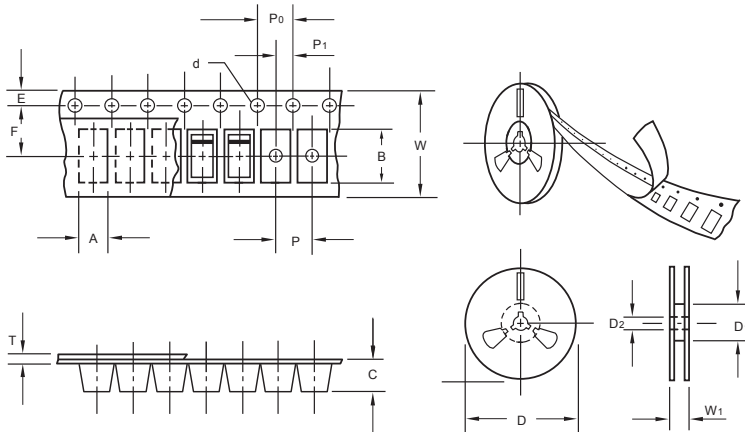

unit:mm

Item	Symbol	Tolerance	SMA
Carrier width	A	0.1	2.80
Carrier length	B	0.1	5.33
Carrier depth	C	0.1	2.36
Sprocket hole	d	0.05	1.50
13" Reel outside diameter	D	2.0	330.00
13" Reel inner diameter	D <sub>1</sub>	min	50.00
7" Reel outside diameter	D	2.0	178.00
7" Reel inner diameter	D <sub>1</sub>	min	62.00
Feed hole diameter	D <sub>2</sub>	0.5	13.00
Sprocket hole position	E	0.1	1.75
Punch hole position	F	0.1	5.50
Punch hole pitch	P	0.1	4.00
Sprocket hole pitch	P <sub>0</sub>	0.1	4.00
Embossment center	P <sub>1</sub>	0.1	2.00
Overall tape thickness	T	0.1	0.28
Tape width	W	0.3	12.00
Reel width	W <sub>1</sub>	1.0	18.00

Note: Devices are packed in accordance with EIA standard RS-481-A and specifications listed above.

## Reel packing

PACKAGE	REEL SIZE	REEL (pcs)	COMPONENT SPACING (m/m)	BOX (pcs)	INNER BOX (m/m)	REEL DIA, (m/m)	CARTON SIZE (m/m)	CARTON (pcs)	APPROX. GROSS WEIGHT (kg)
SMA	7"	2,000	4.0	4,000	183*155*183	178	382*356*392	80,000	16.0
SMA	11"	5,000	4.0	10,000	290*290*38	330	310*310*360	80,000	11.0
SMA	13"	7,500	4.0	15,000	335*335*38	330	350*330*360	120,000	14.5

## Suggested Pad Layout

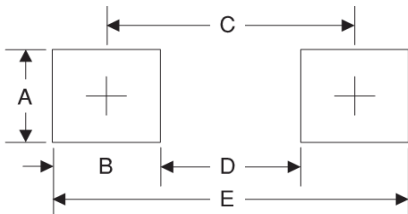

Symbol	Unit (mm)	Unit (inch)
A	1.68	0.066
B	1.52	0.060
C	3.90	0.154
D	2.41	0.095
E	5.45	0.215