

- Specification:
- Electrical Characteristics:
 - Contact Current Rating: 0.5 Amperes.
 - Dielectric Withstanding Voltage: AC500V r.m.s.
 - Insulation Resistance: 1000 MΩ Minimum.
 - Contact Resistance: 40 mΩ Maximum.
 - Environmental:
 - Operating Temperature: -25°C~+90°C.
 - Environmental:
 - Mating Cycles: 5,000 Insertions.
 - Mechanical Characteristics:
 - Card Push Insertion/Out Force: 0.2~1.40kgf.
 - Contact Separation Force: 0.20kgf Minimum.
 - Material:
 - Insulator: HI-Temp Plastic UL 94V-0 Rated.
 - Contact: Copper Alloy (t=0.15mm).
 - Shell: Stainless Steel (t=0.15mm).
 - Spring: SWP.

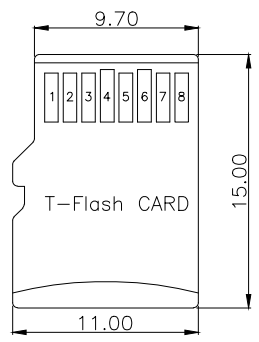

▨ PAD AREA
 ■ KEEP OUT AREA
 RECOMMENDED PCB LAYOUT
 GENERAL TOLERANCE ±0.05

Circuit Diagram for Detect Switch

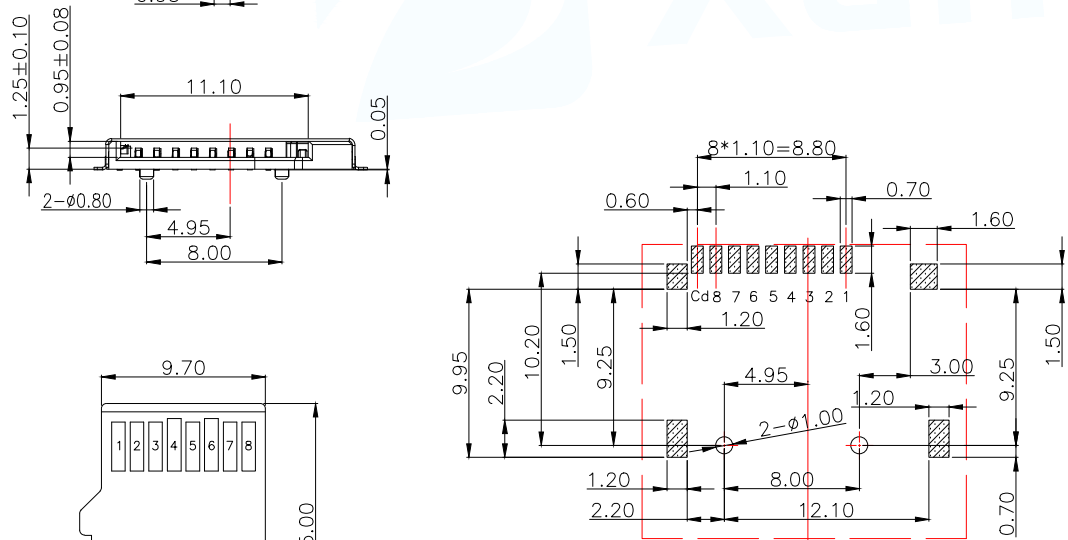
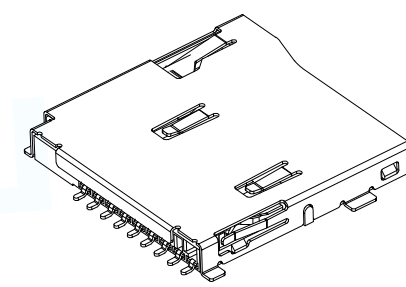
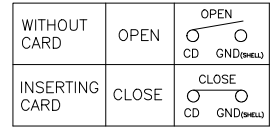

TF CARD PIN DEFINE			
PIN NO.	NAME	YYPE	DESCRIPTION
1	DAT2	I/O/PP	DATE LINE(BIT2)
2	CD/DAT3	I/O/PP	CARD DETECT DATE LIN(BIT3)
3	CMD	PP	COMMAND RESPONSE
4	VDD	S	SUPPLY VOLTAGE
5	CLX	I	CLOCK
6	VSS	S	SUPPLY VOLTAGE GROUND
7	DAT0	I/O/PP	DATE LINE(BIT0)
8	DAT1	I/O/PP	DATE LINE(DIT1)

MANUFACTURE DWG		东莞市讯普电子科技有限公司 DongGuan XunPu Electronics Co.,Ltd	
UNLESS OTHERWISE SPECIFIED TOLERANCES			TITLE: MICRO SD CARD PUSH PUSH SMT 端子镀半金零锡 双弹片
DECIMALS:	ANGLES:		PAR TF-115YY-BCP9
X.X:±0.35	X.X':±3°		DWN
X.XX:±0.25	X.XX':±2°		CHKD
X.XXX:±0.15		APVD	SCALE: 1:1 UNIT: MM
CUSTOMER COPY		SIZE: A4	SHEET: 1F1
			REV: A

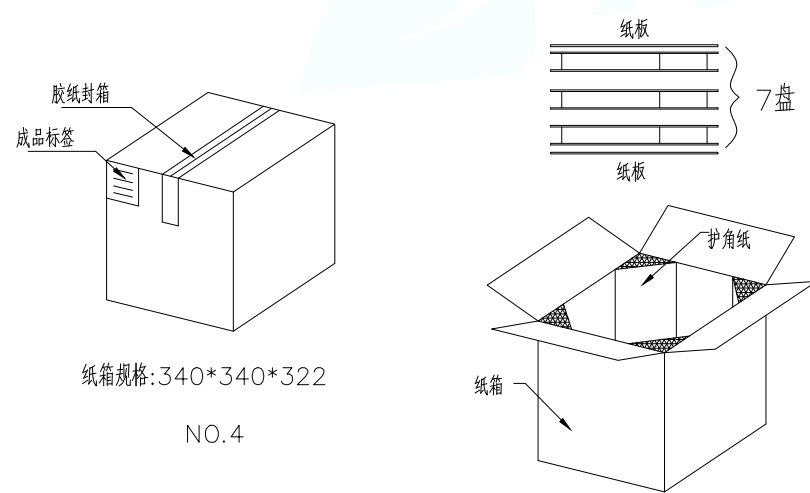
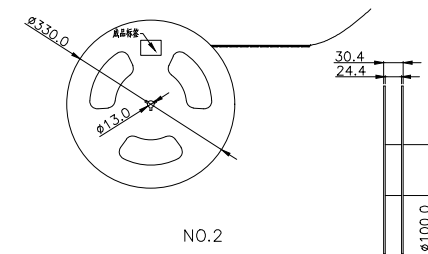
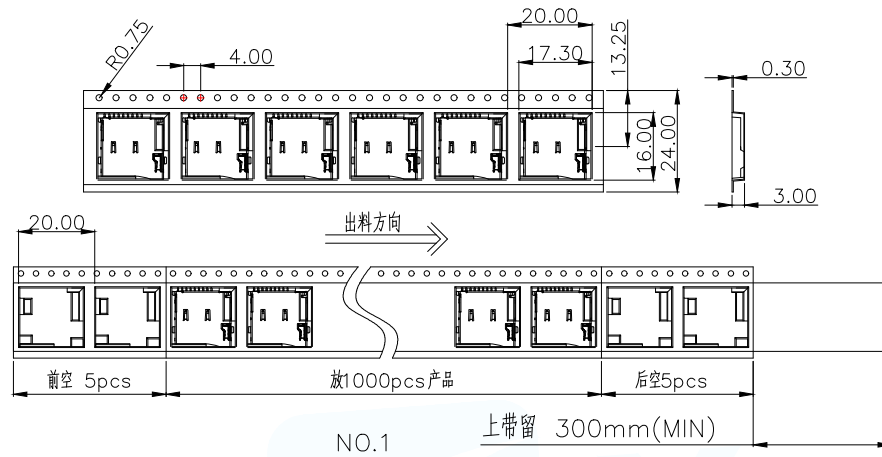

1. 材质要求:

- 1.1 纸箱的材质为K=K;外形尺寸为34*34*32.2;
- 1.2 卷盘的材质为PS,卷盘的外形尺寸为 $\phi 330 \times 30.4$;

2. 包装方式:

- 2.1 将卷带放入包装机后,前空5PCS,后放产品1000PCS,再后空5PCS;上带留300MM长度。
- 2.2 将包装好的产品从包装机上取下并包装好,贴上内盘标签;
- 2.3 把累叠好的7盘叠放入纸箱中共计7Kset,上下放纸板;
- 2.4 把包装好的成品打包封箱,并在纸箱外贴上标签

MANUFACTURE DWG		东莞市讯普电子科技有限公司 DongGuan XunPu Electronics Co.,Ltd	
UNLESS OTHERWISE SPECIFIED TOLERANCES			TITLE:MICRO SD CARD PUSH PUSH SMT 端子镀半金零锡 双弹片
DECIMALS:	ANGLES:		PAR TF-115YY-BCP9
X.X:±0.35	X.X':±3°		DWN
X.XX:±0.25	X.XX':±2°		CHKD
X.XXX:±0.15		APVD	SCALE 1:1 UNIT:MM
CUSTOMER COPY		SIZE:A4	SHEET:1F1
			REV:A