



# ES2A THRU ES2J

Reverse Voltage - 50 to 600 Volts Forward Current - 2.0 Ampere

## SURFACE MOUNT SUPER FAST RECOVERY RECTIFIER

### Features

- ◆ The plastic package carries Underwriters Laboratory Flammability Classification 94V-0
- ◆ For surface mounted applications
- ◆ Low reverse leakage
- ◆ Built-in strain relief, ideal for automated placement
- ◆ High forward surge current capability
- ◆ High temperature soldering guaranteed:
  - ◆ 250°C/10 seconds at terminals
  - ◆ Glass passivated chip junction

DO-214AC/SMA

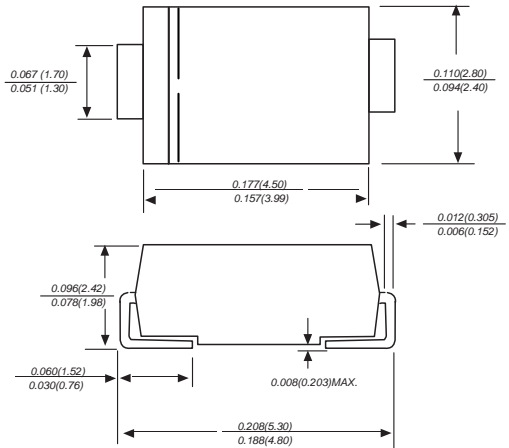

Dimensions in inches and (millimeters)

### Mechanical Data

- Case :** JEDEC DO-214AC/SMA Molded plastic body  
**Terminals :** Solder plated, solderable per MIL-STD-750, Method 2026  
**Polarity :** Polarity symbol marking on body  
**Mounting Position :** Any  
**Weight :** 0.0019 ounce, 0.055grams

### Maximum Ratings And Electrical Characteristics

Ratings at 25°C ambient temperature unless otherwise specified.

Single phase half-wave 60Hz, resistive or inductive load, for capacitive load current derate by 20%.

Parameter	SYMBOLS	MDD ES2A	MDD ES2B	MDD ES2C	MDD ES2D	MDD ES2E	MDD ES2G	MDD ES2J	UNITS
Marking Code									
Maximum repetitive peak reverse voltage	$V_{RRM}$	50	100	150	200	300	400	600	V
Maximum RMS voltage	$V_{RMS}$	35	70	105	140	210	280	420	V
Maximum DC blocking voltage	$V_{DC}$	50	100	150	200	300	400	600	V
Maximum average forward rectified current at $T_c=125^\circ\text{C}$	$I_{(AV)}$	2.0							A
Peak forward surge current 8.3ms single half sine-wave superimposed on rated load (JEDEC Method)	$I_{FSM}$	50							A
Maximum instantaneous forward voltage at 2.0A	$V_F$	1			1.25		1.68		V
Maximum DC reverse current at rated DC blocking voltage $T_A=25^\circ\text{C}$ $T_A=125^\circ\text{C}$	$I_R$	5.0 100.0							$\mu\text{A}$
Maximum reverse recovery time (NOTE 1)	$t_{rr}$	35							ns
Typical junction capacitance (NOTE 2)	$C_J$	40.0							pF
Typical thermal resistance (NOTE 3)	$R_{\theta JA}$	60.0							$^\circ\text{C}/\text{W}$
Operating junction and storage temperature range	$T_J, T_{STG}$	- 55 to + 150							$^\circ\text{C}$

- Note:** 1.Reverse recovery condition  $I_F=0.5\text{A}, I_R=1.0\text{A}, I_{rr}=0.25\text{A}$   
 2.Measured at 1MHz and applied reverse voltage of 4.0V D.C.  
 3.Pulse test: Pulse width 200 sec, Duty cycle 2%  
 4..P.C.B. mounted with 1.0 X 1.0" (2.54 X 2.54 cm) copper pad areas.



# ES2A THRU ES2J

Reverse Voltage - 50 to 600 Volts Forward Current - 2.0 Ampere

## Ratings And Characteristic Curves

Fig.1 Reverse Recovery Time Characteristic And Test Circuit Diagram

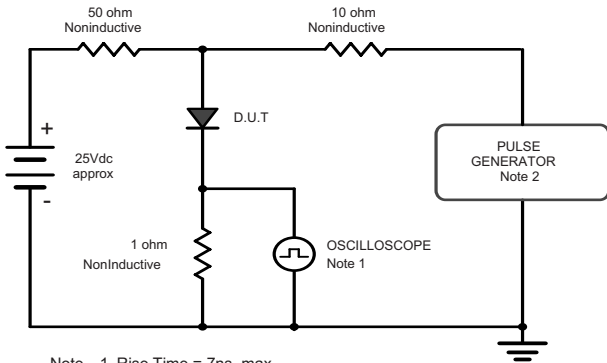

- Note: 1. Rise Time = 7ns, max.  
Input Impedance = 1megohm, 22pF.  
2. Rise Time = 10ns, max.  
Source Impedance = 50 ohms.

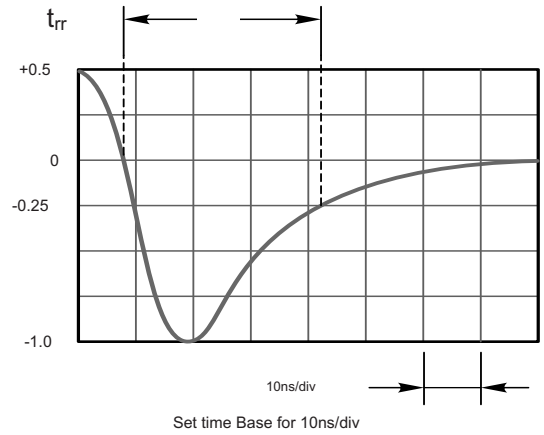

Fig.2 Maximum Average Forward Current Rating

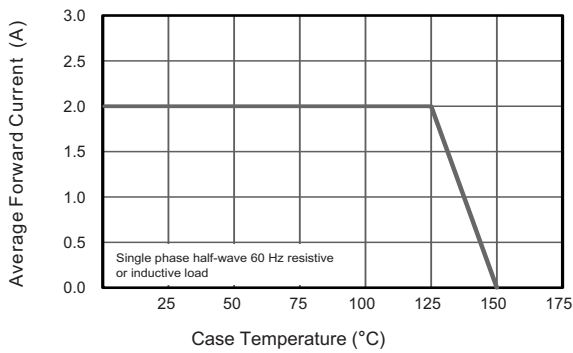

Fig.3 Typical Reverse Characteristics

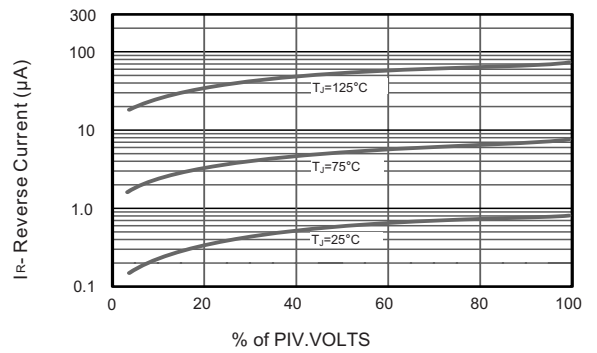

Fig.4 Typical Forward Characteristics

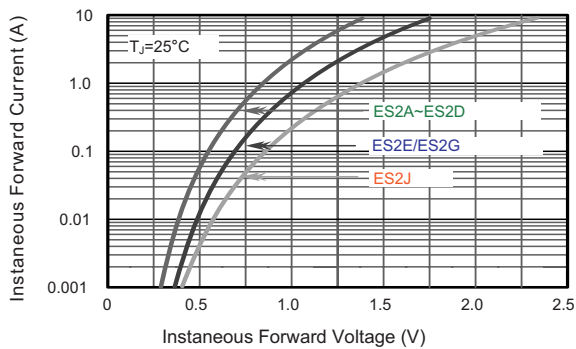

Fig.5 Typical Junction Capacitance

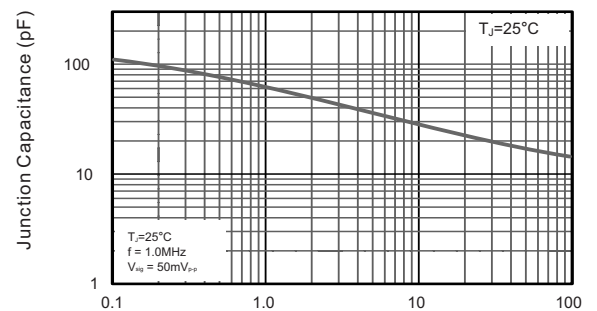
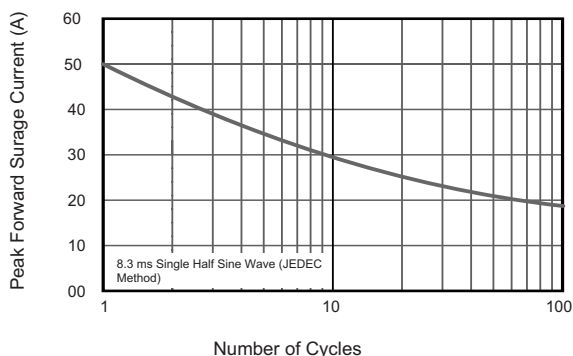

Fig.6 Maximum Non-Repetitive Peak Forward Surge Current



The curve above is for reference only.



# ES2A THRU ES2J

Reverse Voltage - 50 to 600 Volts Forward Current - 2.0 Ampere

## Packing information



unit:mm

Item	Symbol	Tolerance	SMA
Carrier width	A	0.1	2.80
Carrier length	B	0.1	5.33
Carrier depth	C	0.1	2.36
Sprocket hole	d	0.05	1.50
13" Reel outside diameter	D	2.0	330.00
13" Reel inner diameter	D <sub>1</sub>	min	50.00
7" Reel outside diameter	D	2.0	178.00
7" Reel inner diameter	D <sub>1</sub>	min	62.00
Feed hole diameter	D <sub>2</sub>	0.5	13.00
Sprocket hole position	E	0.1	1.75
Punch hole position	F	0.1	5.50
Punch hole pitch	P	0.1	4.00
Sprocket hole pitch	P <sub>0</sub>	0.1	4.00
Embossment center	P <sub>1</sub>	0.1	2.00
Overall tape thickness	T	0.1	0.28
Tape width	W	0.3	12.00
Reel width	W <sub>1</sub>	1.0	18.00

Note: Devices are packed in accordance with EIA standard RS-481-A and specifications listed above.

## Reel packing

PACKAGE	REEL SIZE	REEL (pcs)	COMPONENT SPACING (m/m)	BOX (pcs)	INNER BOX (m/m)	REEL DIA, (m/m)	CARTON SIZE (m/m)	CARTON (pcs)	APPROX. GROSS WEIGHT (kg)
SMA	7"	2,000	4.0	4,000	183*155*183	178	382*356*392	80,000	16.0
SMA	11"	5,000	4.0	10,000	290*290*38	330	310*310*360	80,000	11.0
SMA	13"	7,500	4.0	15,000	335*335*38	330	350*330*360	120,000	14.5

## Suggested Pad Layout



Symbol	Unit (mm)	Unit (inch)
A	1.68	0.066
B	1.52	0.060
C	3.90	0.154
D	2.41	0.095
E	5.45	0.215

## Important Notice and Disclaimer

Microdiode Electronics (Jiangsu) reserves the right to make changes to this document and its products and specifications at any time without notice. Customers should obtain and confirm the latest product information and specifications before final design, purchase or use.

Microdiode Electronics (Jiangsu) makes no warranty, representation or guarantee regarding the suitability of its products for any particular purpose, nor does Microdiode Electronics (Jiangsu) assume any liability for application assistance or customer product design. Microdiode Electronics (Jiangsu) does not warrant or accept any liability with products which are purchased or used for any unintended or unauthorized application.

No license is granted by implication or otherwise under any intellectual property rights of Microdiode Electronics (Jiangsu).

Microdiode Electronics (Jiangsu) products are not authorized for use as critical components in life support devices or systems without express written approval of Microdiode Electronics (Jiangsu).