

## General Description

The Devices is a low-dropout (LDO) voltage regulator with enable function that operates from a 1.2V to 5.5V supply. It provides up to 300mA of output current in miniaturized packaging.

The feature of 2 $\mu$ A low quiescent current and 0.5 $\mu$ A shutdown current are ideal for the battery application with long service life. The other features include current limit function, over temperature protection and output discharge function.

## Features

- 2 $\mu$ A Ground Current at no Load
- $\pm 2\%$  Output Accuracy
- 300mA Output Current
- 10nA Disable Current (by option)
- Wide Operating Input Voltage Range: 1.2V to 5.5V
- Dropout Voltage: 0.18V at 300mA ( $V_{OUT}=3.3V$ )
- Support Fixed Output Voltage 1.2V, 1.5V, 1.6V, 1.8V, 2.5V, 2.8V, 3.0V, 3.3V
- Stable with Ceramic or Tantalum Capacitor
- Current Limit Protection
- Over-Temperature Protection
- SOT23-5 Package

## Applications

- Portable, Battery Powered Equipment
- Low Power Microcontrollers
- Laptop, Palmtops and PDAs
- Wireless Communication Equipment
- Audio/Video Equipment

## Ordering Information

**TPS79333DBVR-TP**

DBVR:SOT23-5 Package

Output voltage: 12=1.2V  
15=1.5V  
18=1.8V  
30=3.0V  
33=3.3V

TPS79333DBVR-TP Marking: PHUI

TPS79318DBVR-TP Marking: PHHI

## BLOCK DIAGRAM

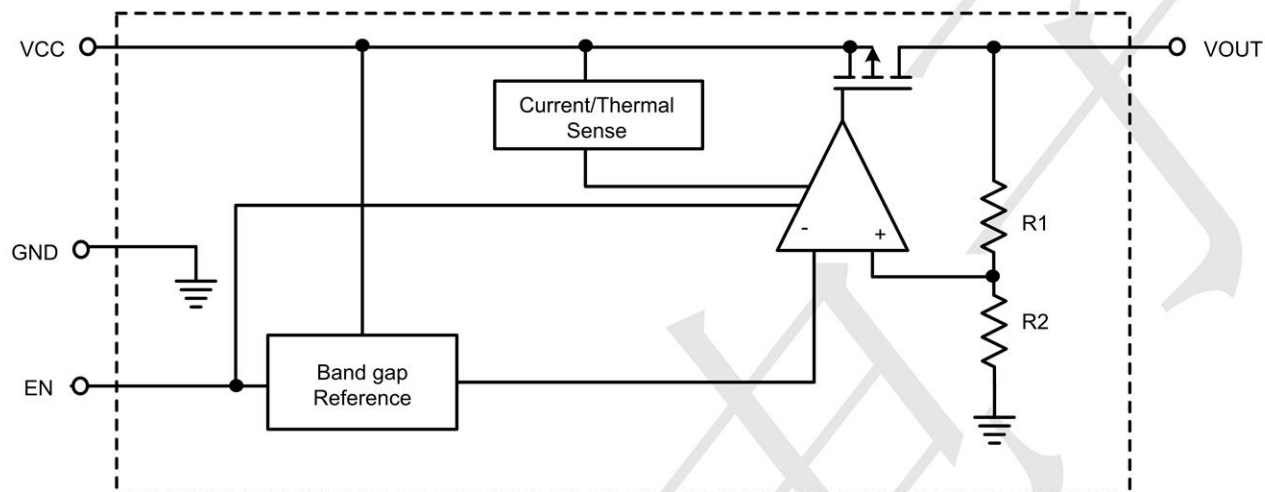

## PIN CONFIGURATION

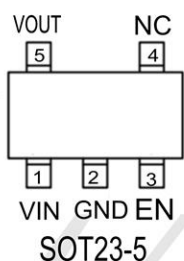

Pin No	Pin Name	Pin Function
1	VIN	Input of Supply Voltage.
2	GND	Ground
3	EN	Enable Control Input.
4	NC	No Internal Connection.
5	VOUT	Output of the Regulator

### Absolute Maximum Rating (T<sub>A</sub>=25°C unless otherwise noted)

- VIN, VOUT, EN to GND ----- -0.3V to 6.5V
- VOUT to VIN ----- -6.5V to 0.3V
- Power Dissipation, P<sub>D</sub> @ T<sub>A</sub> = 25°C  
SOT-23-5 ----- 0.43W
- Package Thermal Resistance (Note 2)  
SOT-23-5, θ<sub>JA</sub> ----- 230.6°C/W  
SOT-23-5, θ<sub>JC</sub> ----- 21.8°C/W
- Lead Temperature (Soldering, 10 sec.) ----- 260°C
- Junction Temperature ----- 150°C
- Storage Temperature Range ----- -65°C to 150°C
- ESD Susceptibility (Note 3)  
HBM (Human Body Model) ----- 2kV

### Electrical Characteristics (T =25°C unless otherwise noted)

(V<sub>OUT</sub> + 1 < V<sub>IN</sub> < 5.5V, T<sub>A</sub> = 25°C, unless otherwise specified)

Parameter	Symbol	Test Conditions	Min	Typ	Max	Unit
Fixed Output Voltage Range	V <sub>OUT</sub>		0.8	--	3.45	V
DC Output Accuracy		I <sub>LOAD</sub> = 1mA	-2	--	2	%
Dropout Voltage (I <sub>LOAD</sub> = 300mA) (Note 5)	V <sub>DROP</sub>	0.8V ≤ V <sub>OUT</sub> < 1.05V	--	0.7	0.97	V
		1.05V ≤ V <sub>OUT</sub> < 1.2V	--	0.5	0.92	
		1.2V ≤ V <sub>OUT</sub> < 1.5V	--	0.4	0.57	
		1.5V ≤ V <sub>OUT</sub> < 1.8V	--	0.3	0.47	
		1.8V ≤ V <sub>OUT</sub> < 2.1V	--	0.24	0.33	
		2.1V ≤ V <sub>OUT</sub> < 2.5V	--	0.21	0.3	
		2.5V ≤ V <sub>OUT</sub> < 2.8V	--	0.18	0.25	
		2.8V ≤ V <sub>OUT</sub> < 3V	--	0.16	0.23	
		3V ≤ V <sub>OUT</sub>	--	0.15	0.2	
Dropout Voltage (I <sub>LOAD</sub> = 200mA) (Note 6)	V <sub>DROP</sub>	1.8V ≤ V <sub>OUT</sub> < 2.1V	--	0.16	0.2	V
V <sub>CC</sub> Consumption Current	I <sub>Q</sub>	I <sub>LOAD</sub> = 0mA, V <sub>OUT</sub> ≤ 5.5V V <sub>IN</sub> ≥ V <sub>OUT</sub> + V <sub>DROP</sub>	--	2	4	μA

Parameter	Symbol	Test Conditions	Min	Typ	Max	Unit	
Shutdown GND Current (Note 7)		$V_{EN} = 0V$	--	0.1	0.5	$\mu A$	
Shutdown Leakage Current (Note 7)		$V_{EN} = 0V, V_{OUT} = 0V$	--	0.1	0.5	$\mu A$	
EN Input Current	$I_{EN}$	$V_{EN} = 5.5V$	--	--	0.1	$\mu A$	
Line Regulation	$\Delta LINE$	$I_{LOAD} = 1mA$	$1.2V \leq V_{IN} < 1.5V$	--	0.3	0.6	%
			$1.5V \leq V_{IN} < 1.8V$	--	0.15	0.3	
			$1.8V \leq V_{IN} \leq 5.5V$	--	0.13	0.35	
Load Regulation	$\Delta LOAD$	$1mA < I_{LOAD} < 300mA$	--	0.5	1	%	
Power Supply Rejection Ratio	PSRR	$V_{IN} = 3V, I_{LOAD} = 50mA, C_{OUT} = 1\mu F, V_{OUT} = 2.5V, f = 1kHz$	--	75	--	dB	
Output Voltage Noise		$C_{OUT} = 1\mu F, I_{LOAD} = 150mA, BW = 10Hz \text{ to } 100kHz, V_{IN} = V_{OUT} + 1V$	$V_{OUT} = 0.8V$	--	38	--	$\mu V_{RMS}$
			$V_{OUT} = 1.2V$	--	46	--	
			$V_{OUT} = 1.8V$	--	48	--	
			$V_{OUT} = 3.3V$	--	51	--	
Output Current Limit	$I_{LIM}$	$V_{OUT} = 90\% \text{ of } V_{OUT(NOM)}$	350	600	--	mA	
Enable Threshold Voltage	H-Level	$V_{ENH}$	$V_{IN} = 5V$	0.5	0.7	0.9	V
	L-Level	$V_{ENL}$	$V_{IN} = 5V$	0.4	0.65	0.85	
Thermal Shutdown Temperature	$T_{SD}$	$I_{LOAD} = 30mA, V_{IN} \geq 1.5V$	--	150	--	$^{\circ}C$	
Thermal Shutdown Hysteresis	$\Delta T_{SD}$		--	20	--	$^{\circ}C$	
Discharge Resistance		$EN = 0V, V_{OUT} = 0.1V$	--	80	--	$\Omega$	

## TYPICAL APPLICATION

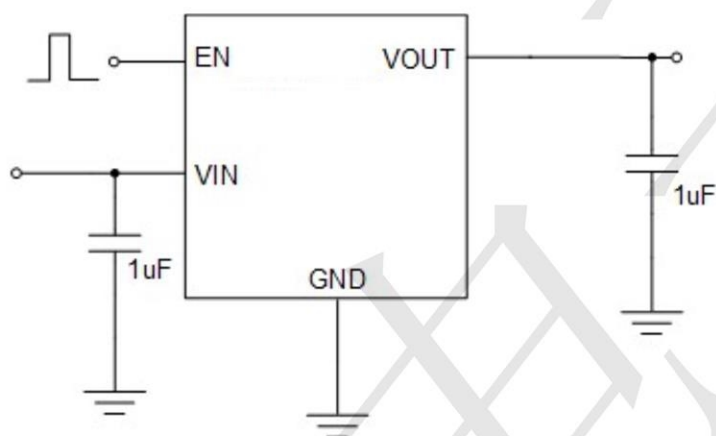

Application circuit of Fixed  $V_{OUT}$  LDO with enable function



## Typical Operating Characteristics

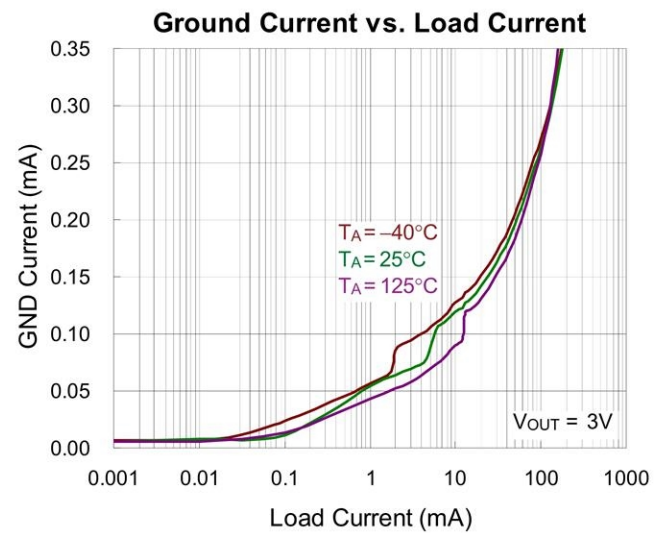
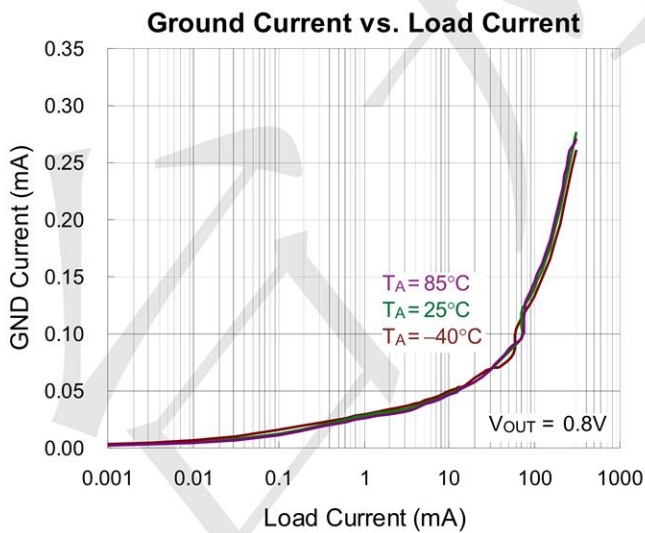
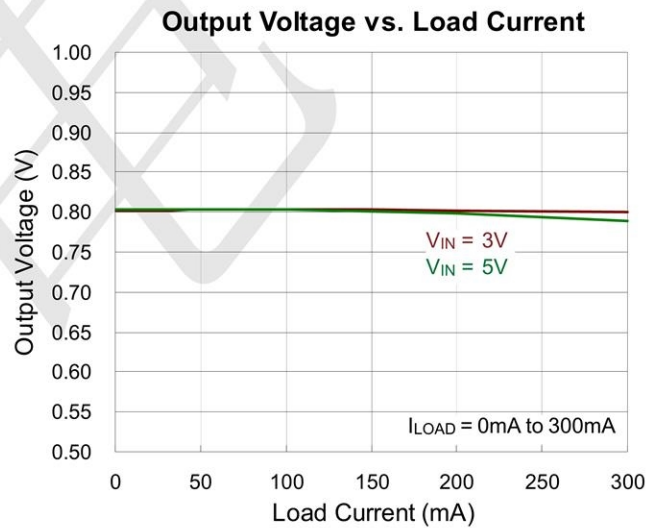
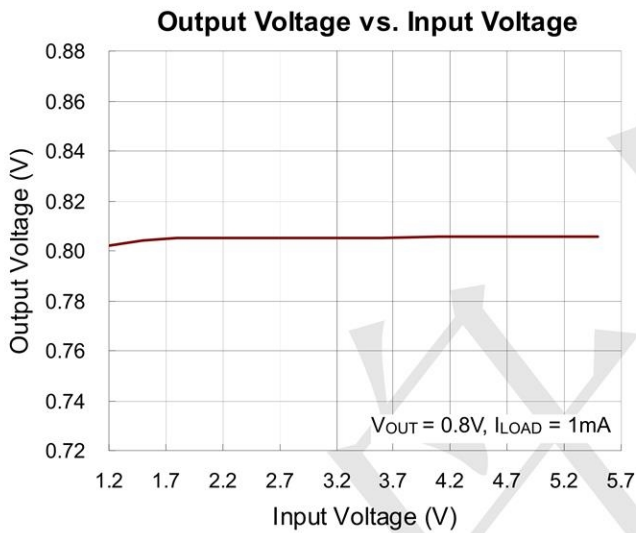
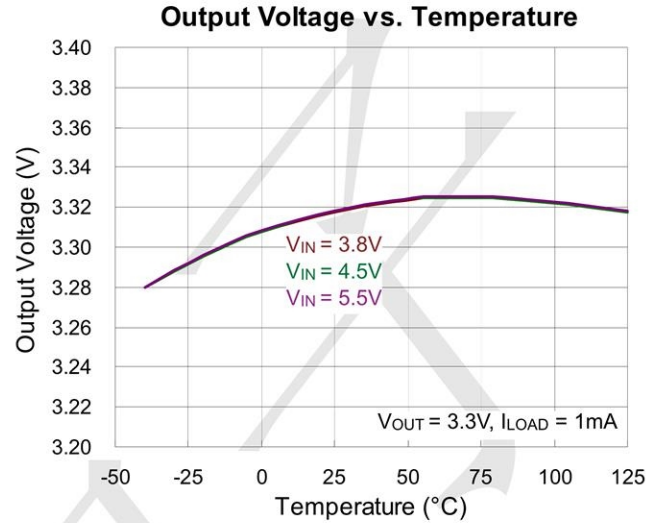
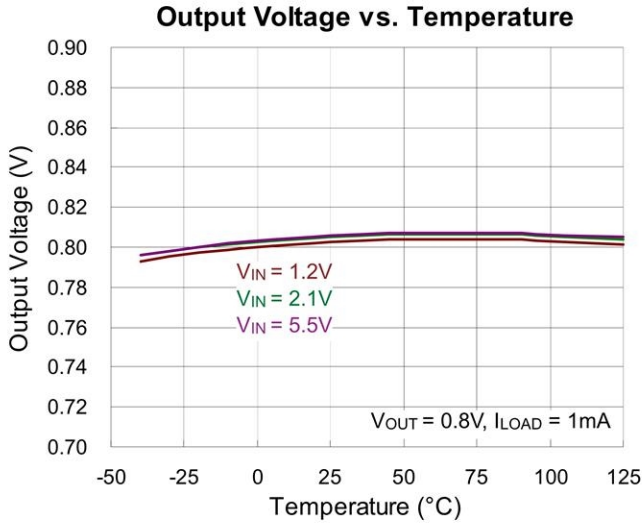

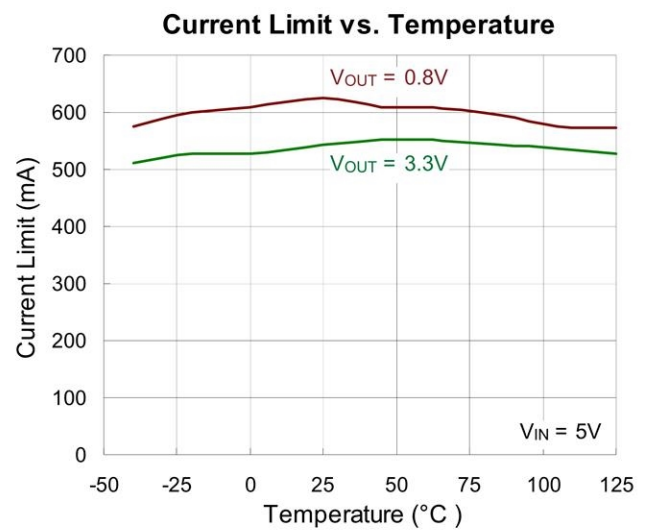
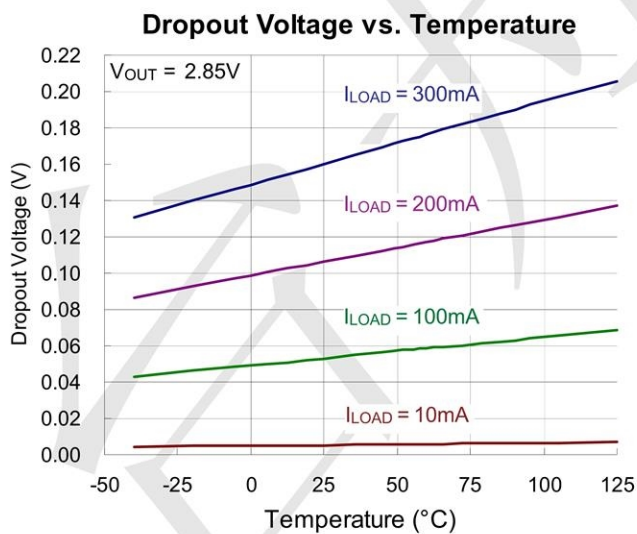
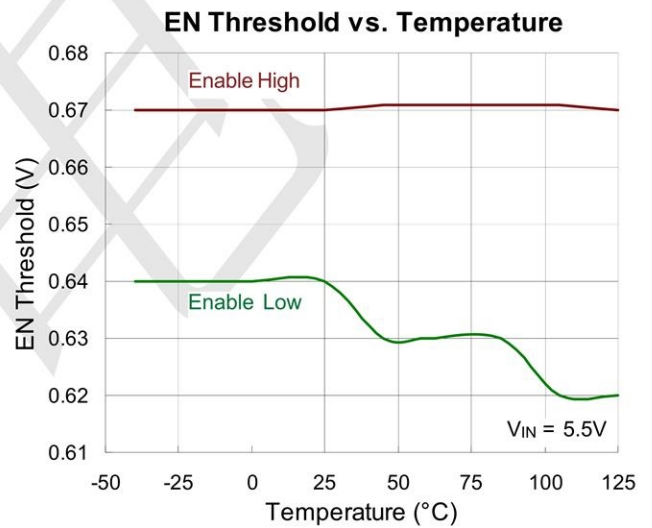
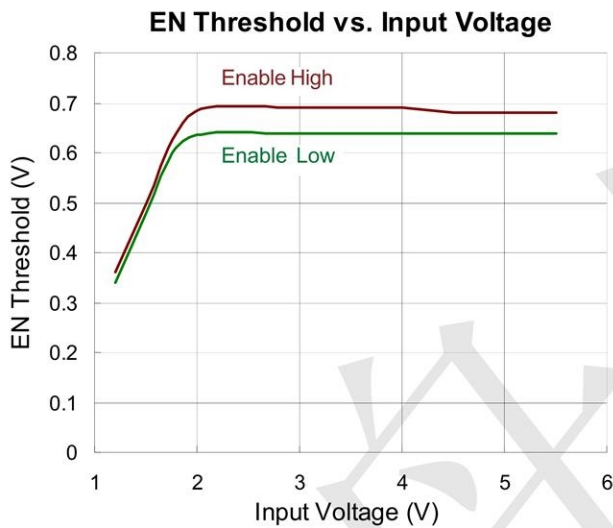
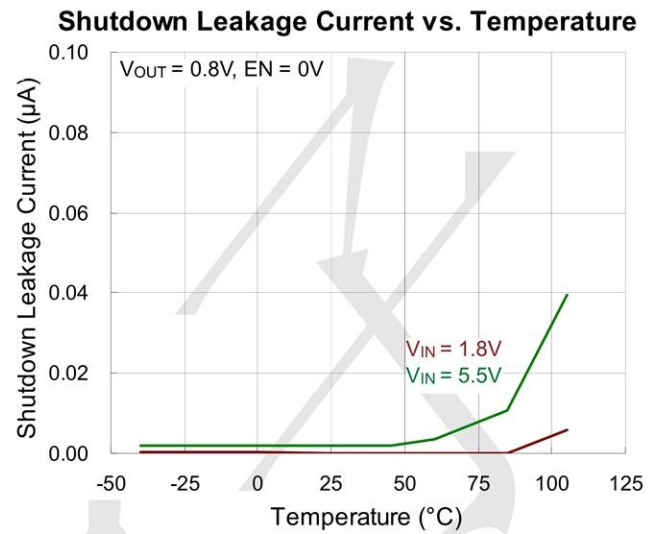
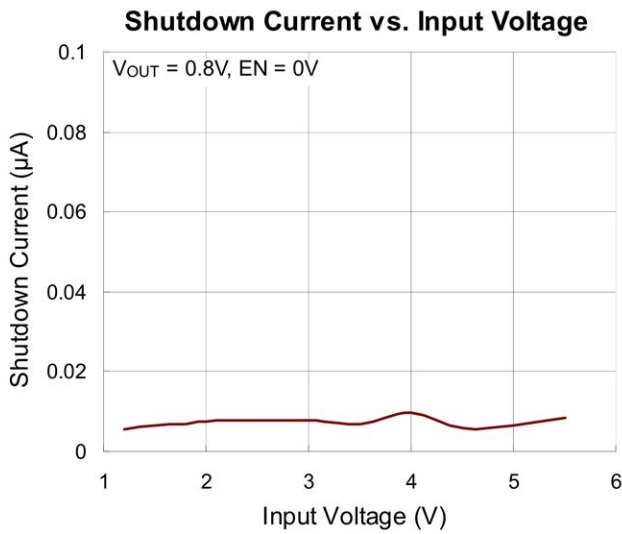



Fold-Back Current Limit vs. Temperature

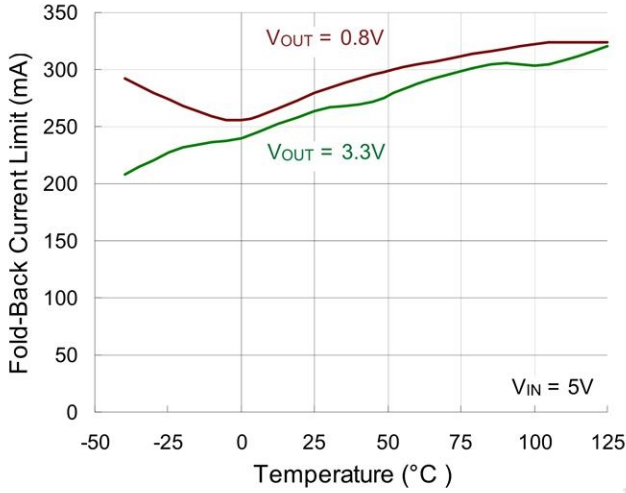

SNS Input Current vs. Temperature

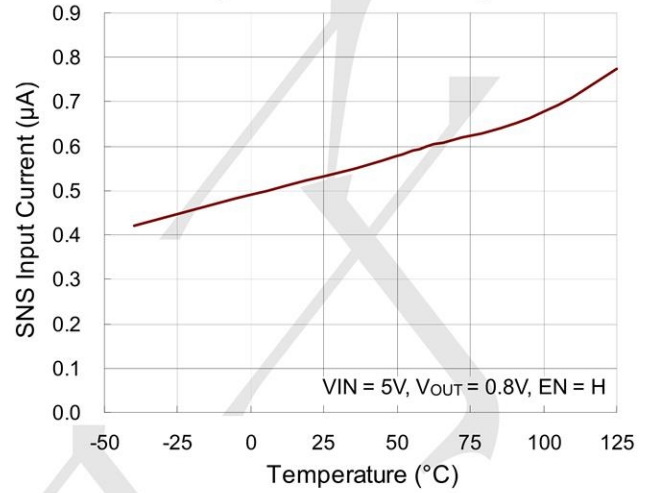

Power On from EN

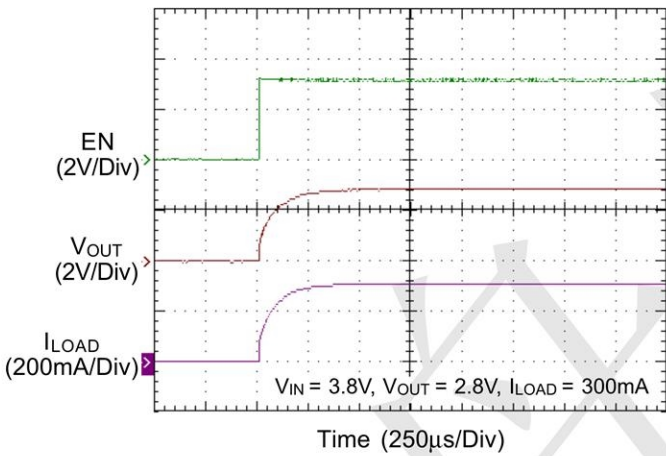

Power Off from EN

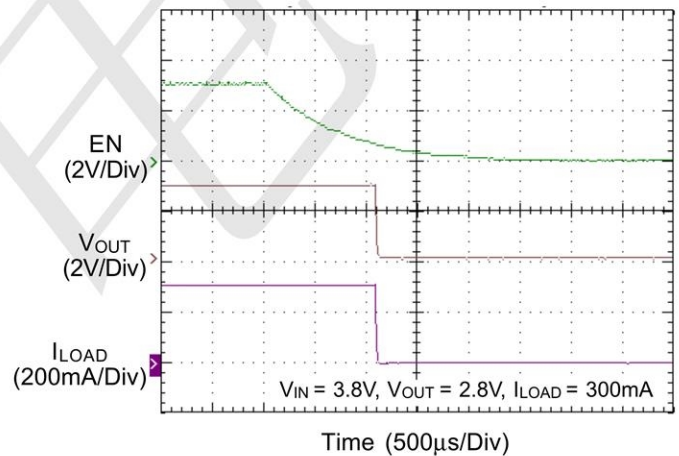

Line Transient

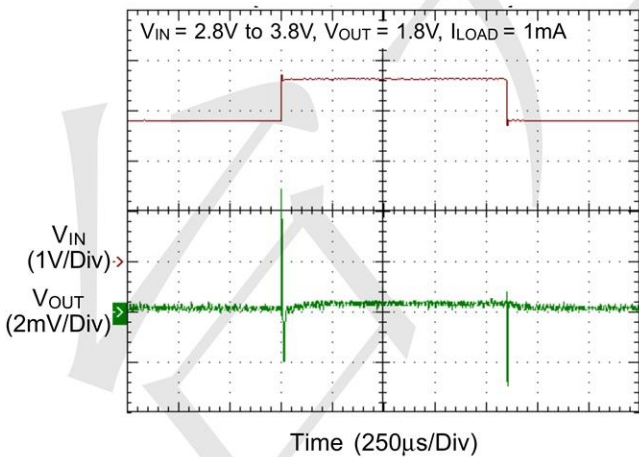

Load Transient

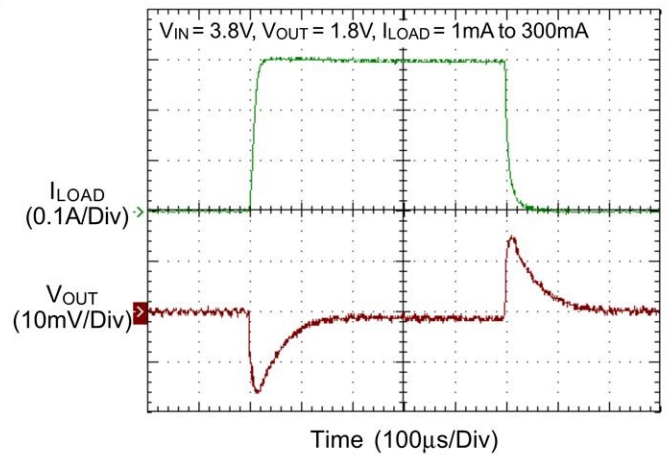





Output Current Limit Protection

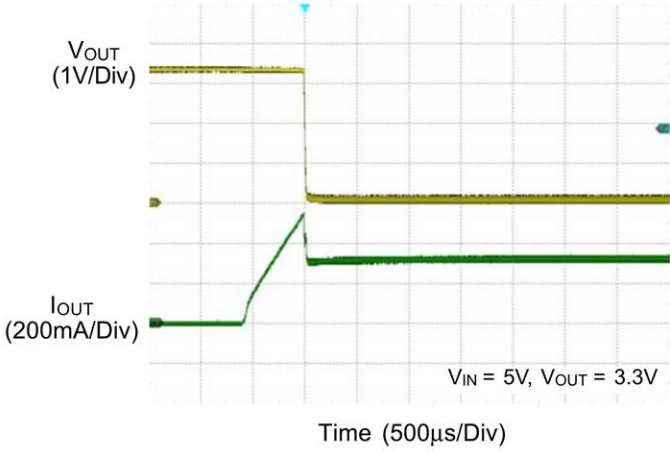

PSRR vs. Frequency

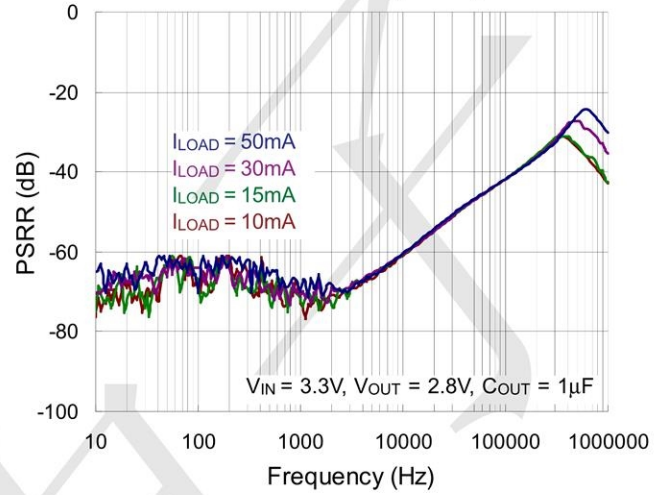

PSRR vs. Frequency

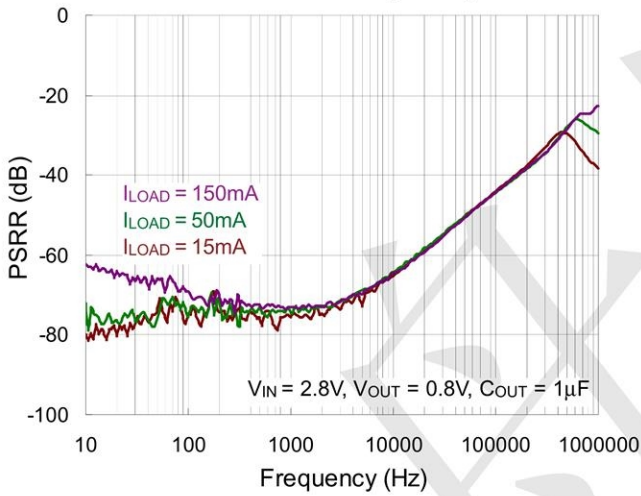

Output Noise vs. Frequency

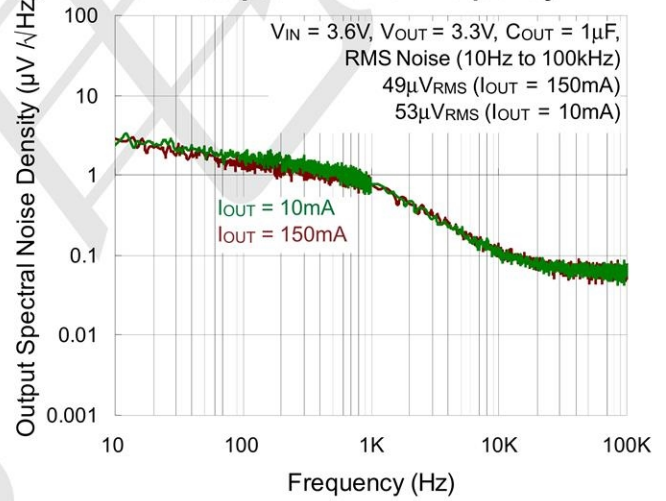



**Package informantion**

**3-pin SOT23-5 Outline Dimensions**

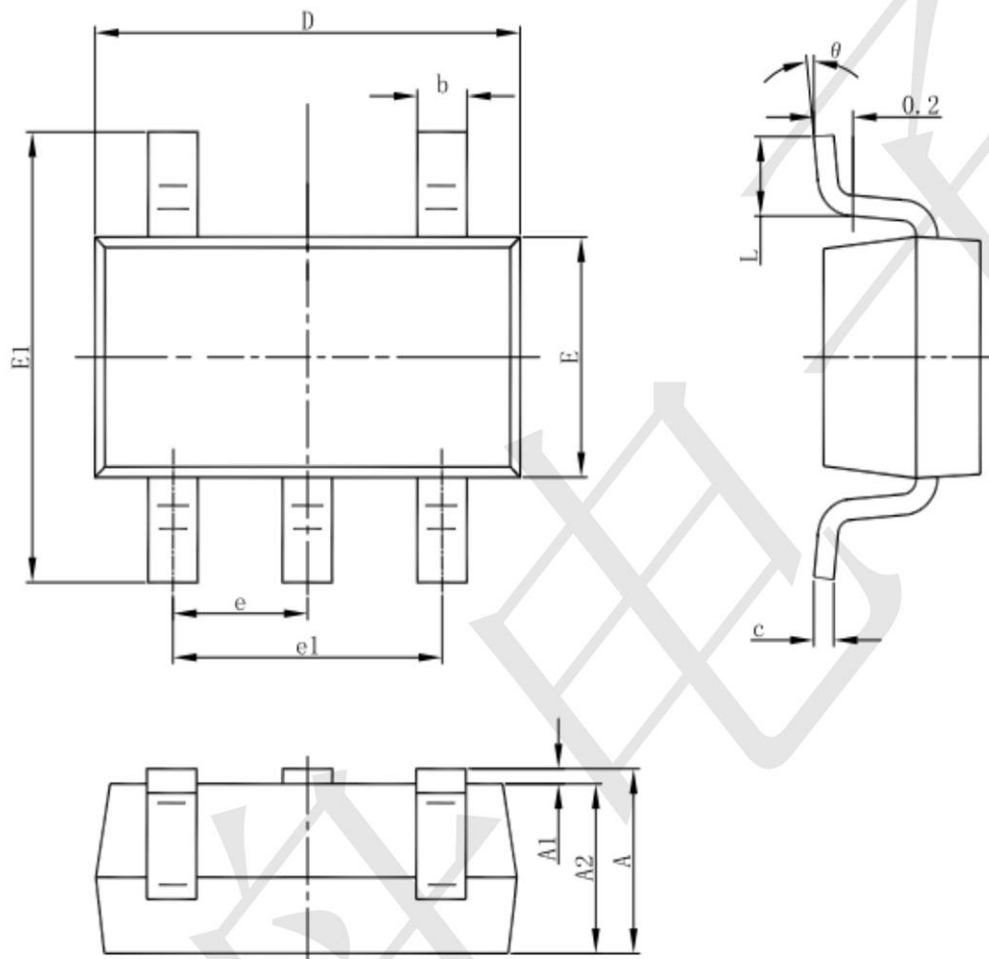

Symbol	Dimensions In Millimeters		Dimensions In Inches	
	Min	Max	Min	Max
A	1.050	1.250	0.041	0.049
A1	0.000	0.100	0.000	0.004
A2	1.050	1.150	0.041	0.045
b	0.300	0.500	0.012	0.020
c	0.100	0.200	0.004	0.008
D	2.820	3.020	0.111	0.119
E	1.500	1.700	0.059	0.067
E1	2.650	2.950	0.104	0.116
e	0.950(BSC)		0.037(BSC)	
e1	1.800	2.000	0.071	0.079
L	0.300	0.600	0.012	0.024
theta	0°	8°	0°	8°