

Features

- 2μA Ground Current at no Load
- ±2% Output Accuracy
- 300mA Output Current
- Wide Operating Input Voltage Range: 2V to 24V
- Dropout Voltage: 0.35V at 100mA ($V_{OUT}=5V$)
- Support Fixed Output Voltage 1.8V, 3.3V, 5V,
- Stable with Ceramic or Tantalum Capacitor
- Current Limit Protection
- Over-Temperature Protection
- SOT-23-5 Package Available
- NCP718ASN500T1G Pin to Pin Fully Compatible

Applications

- Portable, Battery Powered Equipment
- Low Power Microcontrollers
- Laptop, Palmtops and PDAs
- Wireless Communication Equipment
- Audio/Video Equipment
- Car Navigation Systems
- Industrial Controls
- Weighting Scales
- Meters
- Home Automation

General Description

The Devices is a low-dropout (LDO) voltage regulators with enable function offering the benefits of high input voltage, low-dropout voltage, low-power consumption, and miniaturized packaging.

The features of low quiescent current as low as 2.0μA and zero disable current is ideal for powering the battery equipment to a longer service life. The Devices

is stable with the ceramic output capacitor over its wide input range from 2V to 24V and the entire range of output load current.

Ordering Information

TPNCP718ASN330T1G

Output voltage: 330=3.3V
500=5.0V
180=1.8V

Marking

TPNCP718ASN330T1G

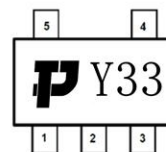

TPNCP718ASN500T1G

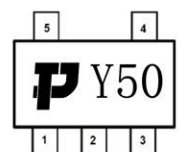

TPNCP718ASN180T1G

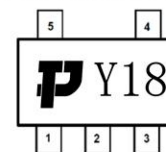

PIN CONFIGURATION

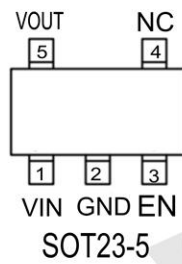

Pin No	Pin Name	Pin Function
1	VIN	Input of Supply Voltage.
2	GND	Ground
3	EN	Enable Control Input.
4	NC	No Internal Connection.
5	VOUT	Output of the Regulator

BLOCK DIAGRAM

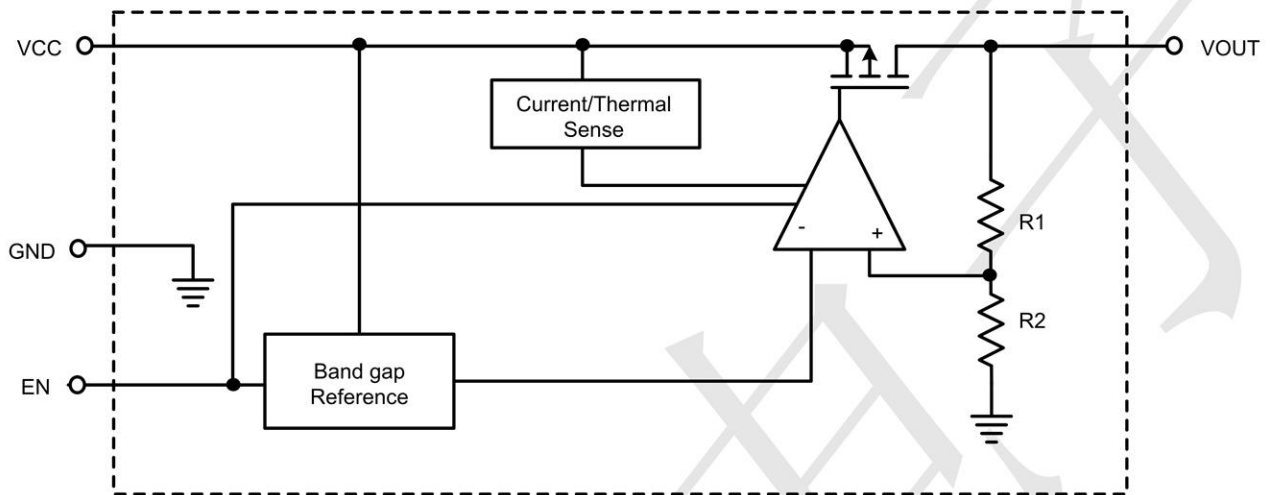

Absolute Maximum Ratings

VIN Pin to GND Pin Voltage	-0.3V to 27V
VOUT Pin to GND Pin Voltage	-0.3V to 6.0V
VOUT Pin to VIN Pin Voltage	-27V to 0.3V
Package Thermal Resistance (Note 2)	
SOT-23-5, SOT-23-3, θ_{JA}	200 °C /W
Lead Temperature (Soldering, 10 sec.)	260 °C
Junction Temperature	150 °C
Storage Temperature Range	-40 °C to 150 °C
ESD Susceptibility	
HBM	2KV
MM	200V

Recommended Operating Conditions

Supply Input Voltage	-2.0V to 24V
Junction Temperature Range	-40 °C to 125 °C
Ambient Temperature Range	-40 °C to 85 °C

Electrical Characteristics

($V_{IN}=15V$, $V_{EN}=5V$, $T_A=25^{\circ}C$, unless otherwise specified) (Note 1)

Parameter	Symbol	Test Conditions	Min	Typ	Max	Unit
Supply Voltage	V_{IN}		2	--	24	V
DC Output Voltage Accuracy		$I_{LOAD} = 0.1mA$	-2		2	%
Dropout Voltage ($I_{LOAD} = 100mA$)	V_{DROP}	$V_{OUT} \geq 5V$	--	0.35		V
	$V_{DROP_3.3V}$	$V_{OUT} = 3.3V$		0.42		
	$V_{DROP_1.8V}$	$V_{OUT} = 1.8V$		0.5		
Ground Current ($I_{LOAD} = 0mA$)	I_Q	$V_{OUT} \leq 5V$		2.0	4.5	μA
Shutdown Ground Current	I_{SD}	$V_{EN} = 0V$, $V_{OUT} = 0V$		0.01	0.5	μA
V_{OUT} Shutdown Leakage Current	I_{LEAK}			0.01	0.5	μA
Enable Threshold Voltage	V_{IH}	EN Rising	1.1			V
	V_{IL}	EN Falling			0.4	
EN Input Current	I_{EN}	$V_{EN} = 27V$		10	100	nA
Line Regulation	$\Delta LINE$	$I_{LOAD} = 1mA$, $10 \leq V_{IN} \leq 20V$	--	0.3		%
Load Regulation	$\Delta LOAD$	$10mA \leq I_{LOAD} \leq 0.2A$		0.3		%
Output Current Limit	I_{LIM}	$V_{OUT} = 0$	300	500		mA
Power Supply Rejection Ratio	PSRR	$V_{OUT} = 5V$, $I_{LOAD} = 30mA$, $V_{IN} = 12V$, $f = 1kHz$		70		dB
Thermal Shutdown Temperature	T_{SD}	$I_{LOAD} = 10mA$	--	160	--	$^{\circ}C$
Thermal Shutdown Hysteresis	ΔT_{SD}				15	$^{\circ}C$

Typical Operating Characteristics

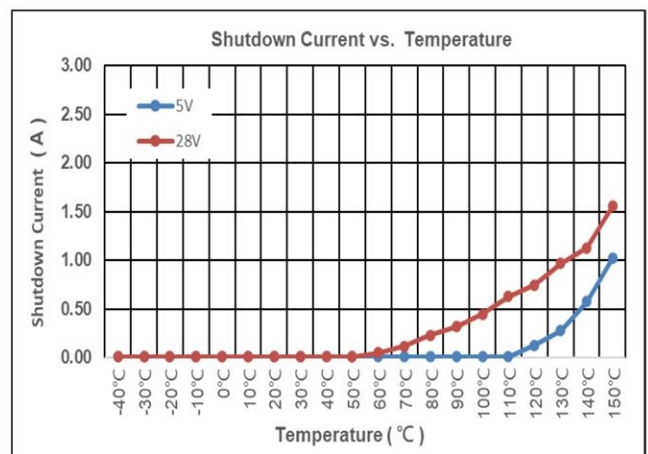
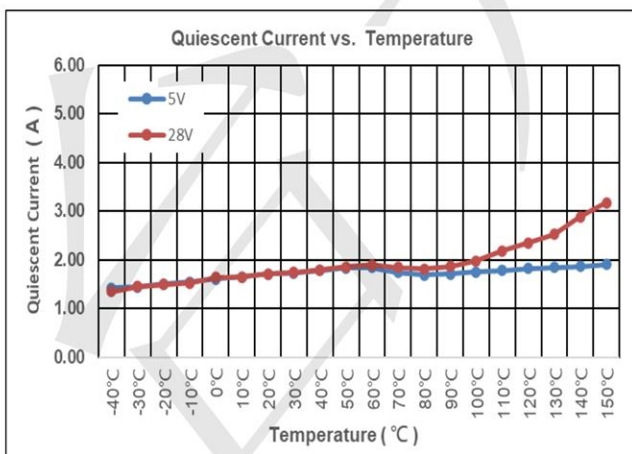
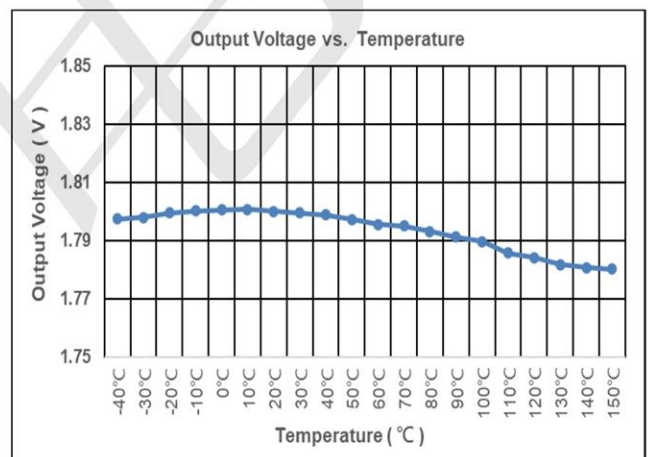
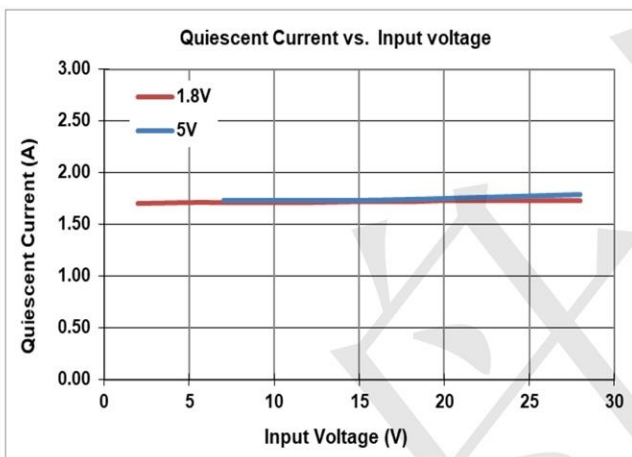
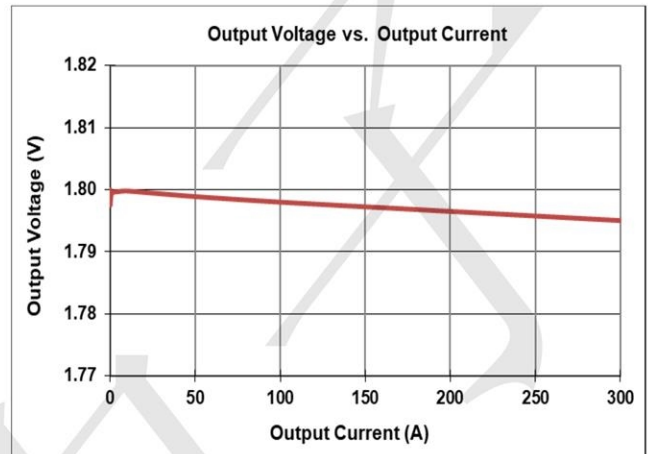
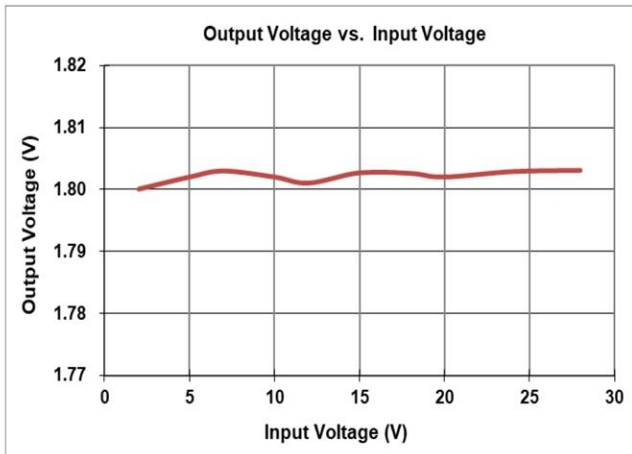

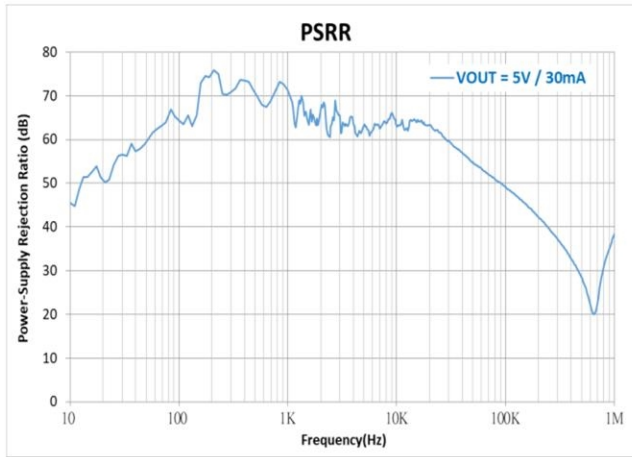

Typical Application Circuit

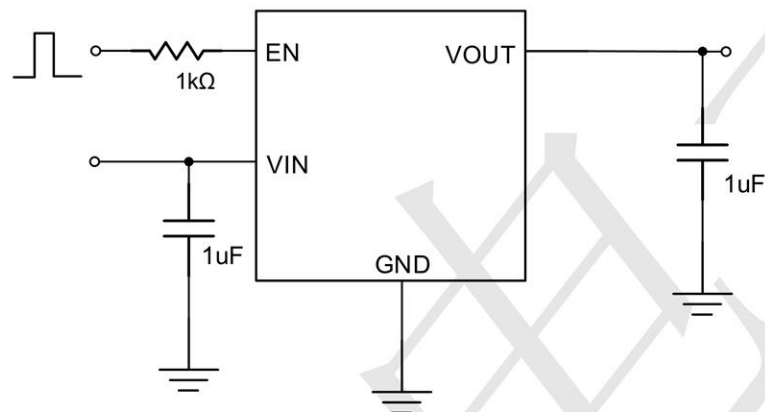

Figure 1: Application circuit of Fixed VOUT LDO with enable function



TECH PUBLIC

—台丹电子—

TPNCP718ASN500T1G

24V ,300mA,2uA, Higt PSRR Voltage Reaulator

www.sot23.com.tw

Package informantion

SOT23-5

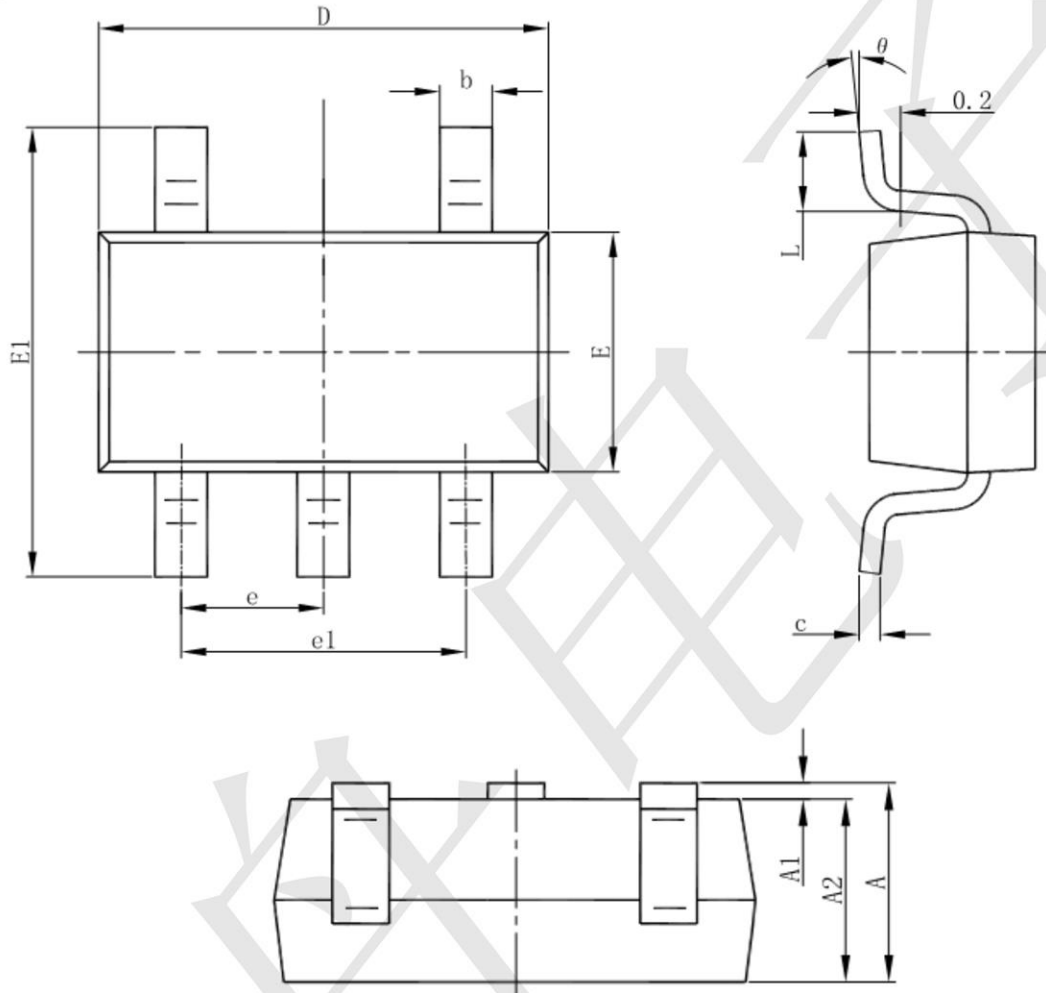

Symbol	Dimensions In Millimeters		Dimensions In Inches	
	Min	Max	Min	Max
A	1.050	1.250	0.041	0.049
A1	0.000	0.100	0.000	0.004
A2	1.050	1.150	0.041	0.045
b	0.300	0.500	0.012	0.020
c	0.100	0.200	0.004	0.008
D	2.820	3.020	0.111	0.119
E	1.500	1.700	0.059	0.067
E1	2.650	2.950	0.104	0.116
e	0.950(BSC)		0.037(BSC)	
e1	1.800	2.000	0.071	0.079
L	0.300	0.600	0.012	0.024
theta	0°	8°	0°	8°

WWW.TECHPUBLIC.COM.TW