

## General Description

The Devices is a low-dropout (LDO) voltage regulator with enable function that operates from a 1.2V to 5.5V supply. It provides up to 300mA of output current in miniaturized packaging.

The feature of 2 $\mu$ A low quiescent current and 0.5 $\mu$ A shutdown current are ideal for the battery application with long service life. The other features include current limit function, over temperature protection and output discharge function.

## Features

- 2 $\mu$ A Ground Current at no Load
- $\pm 2\%$  Output Accuracy
- 300mA Output Current
- 10nA Disable Current (by option)
- Wide Operating Input Voltage Range: 1.2V to 5.5V
- Dropout Voltage: 0.18V at 300mA ( $V_{OUT}=3.3V$ )
- Support Fixed Output Voltage 1.2V, 1.5V, 1.6V, 1.8V, 2.5V, 2.8V, 3.0V, 3.3V
- Stable with Ceramic or Tantalum Capacitor
- Current Limit Protection
- Over-Temperature Protection
- SOT23-5 Package

## Applications

- Portable, Battery Powered Equipment
- Low Power Microcontrollers
- Laptop, Palmtops and PDAs
- Wireless Communication Equipment
- Audio/Video Equipment

## Ordering Information

TPLP5907MFX-1.8

Output voltage: 1.2=1.2V  
1.5=1.5V  
1.8=1.8V  
3.0=3.0V  
3.3=3.3V

MF:SOT23-5 Package

TPLP5907MFX-3.3 Marking: LLVB  
TPLP5907MFX-1.8 Marking: LLUB

## BLOCK DIAGRAM

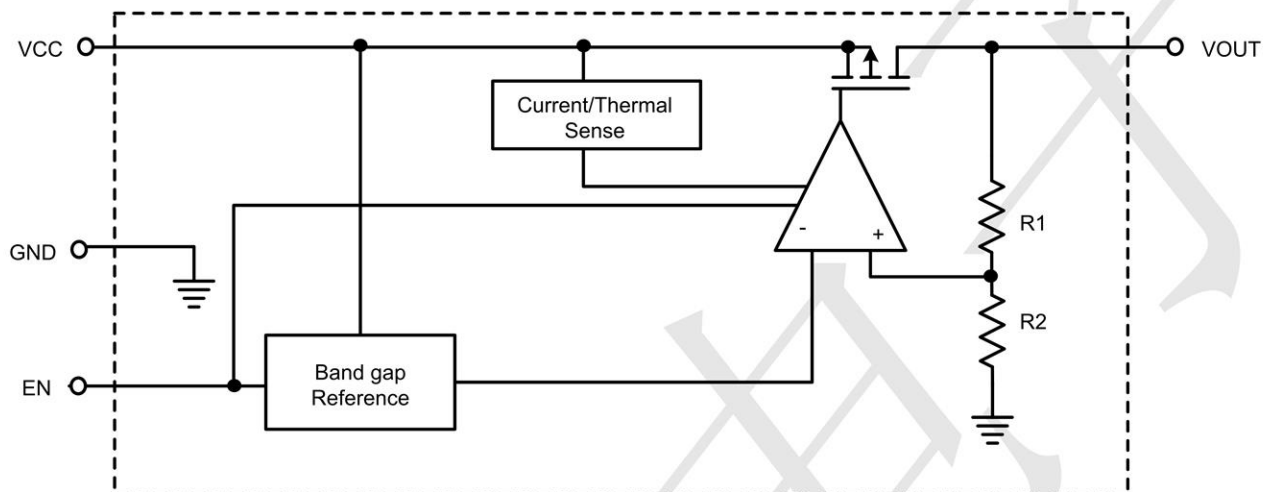

## PIN CONFIGURATION

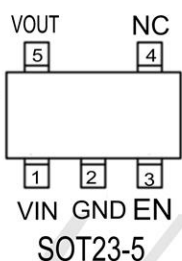

Pin No	Pin Name	Pin Function
1	VIN	Input of Supply Voltage.
2	GND	Ground
3	EN	Enable Control Input.
4	NC	No Internal Connection.
5	VOUT	Output of the Regulator

**Absolute Maximum Rating** ( $T_A=25^{\circ}\text{C}$  unless otherwise noted)

- VIN, VOUT, EN to GND ----- -0.3V to 6.5V
- VOUT to VIN ----- -6.5V to 0.3V
- Power Dissipation,  $P_D$  @  $T_A = 25^{\circ}\text{C}$   
SOT-23-5 ----- 0.43W
- Package Thermal Resistance (Note 2)  
SOT-23-5,  $\theta_{JA}$  ----- 230.6 $^{\circ}\text{C/W}$   
SOT-23-5,  $\theta_{JC}$  ----- 21.8 $^{\circ}\text{C/W}$
- Lead Temperature (Soldering, 10 sec.) ----- 260 $^{\circ}\text{C}$
- Junction Temperature ----- 150 $^{\circ}\text{C}$
- Storage Temperature Range ----- -65 $^{\circ}\text{C}$  to 150 $^{\circ}\text{C}$
- ESD Susceptibility (Note 3)  
HBM (Human Body Model) ----- 2kV

**Electrical Characteristics** ( $T = 25^{\circ}\text{C}$  unless otherwise noted)

( $V_{OUT} + 1 < V_{IN} < 5.5\text{V}$ ,  $T_A = 25^{\circ}\text{C}$ , unless otherwise specified)

Parameter	Symbol	Test Conditions	Min	Typ	Max	Unit
Fixed Output Voltage Range	$V_{OUT}$		0.8	--	3.45	V
DC Output Accuracy		$I_{LOAD} = 1\text{mA}$	-2	--	2	%
Dropout Voltage ( $I_{LOAD} = 300\text{mA}$ ) (Note 5)	$V_{DROP}$	$0.8\text{V} \leq V_{OUT} < 1.05\text{V}$	--	0.7	0.97	V
		$1.05\text{V} \leq V_{OUT} < 1.2\text{V}$	--	0.5	0.92	
		$1.2\text{V} \leq V_{OUT} < 1.5\text{V}$	--	0.4	0.57	
		$1.5\text{V} \leq V_{OUT} < 1.8\text{V}$	--	0.3	0.47	
		$1.8\text{V} \leq V_{OUT} < 2.1\text{V}$	--	0.24	0.33	
		$2.1\text{V} \leq V_{OUT} < 2.5\text{V}$	--	0.21	0.3	
		$2.5\text{V} \leq V_{OUT} < 2.8\text{V}$	--	0.18	0.25	
		$2.8\text{V} \leq V_{OUT} < 3\text{V}$	--	0.16	0.23	
		$3\text{V} \leq V_{OUT}$	--	0.15	0.2	
Dropout Voltage ( $I_{LOAD} = 200\text{mA}$ ) (Note 6)	$V_{DROP}$	$1.8\text{V} \leq V_{OUT} < 2.1\text{V}$	--	0.16	0.2	V
$V_{CC}$ Consumption Current	$I_Q$	$I_{LOAD} = 0\text{mA}$ , $V_{OUT} \leq 5.5\text{V}$ $V_{IN} \geq V_{OUT} + V_{DROP}$	--	2	4	$\mu\text{A}$

Parameter	Symbol	Test Conditions	Min	Typ	Max	Unit	
Shutdown GND Current (Note 7)		$V_{EN} = 0V$	--	0.1	0.5	$\mu A$	
Shutdown Leakage Current (Note 7)		$V_{EN} = 0V, V_{OUT} = 0V$	--	0.1	0.5	$\mu A$	
EN Input Current	$I_{EN}$	$V_{EN} = 5.5V$	--	--	0.1	$\mu A$	
Line Regulation	$\Delta LINE$	$I_{LOAD} = 1mA$	$1.2V \leq V_{IN} < 1.5V$	--	0.3	0.6	%
			$1.5V \leq V_{IN} < 1.8V$	--	0.15	0.3	
			$1.8V \leq V_{IN} \leq 5.5V$	--	0.13	0.35	
Load Regulation	$\Delta LOAD$	$1mA < I_{LOAD} < 300mA$	--	0.5	1	%	
Power Supply Rejection Ratio	PSRR	$V_{IN} = 3V, I_{LOAD} = 50mA, C_{OUT} = 1\mu F, V_{OUT} = 2.5V, f = 1kHz$	--	75	--	dB	
Output Voltage Noise		$C_{OUT} = 1\mu F, I_{LOAD} = 150mA, BW = 10Hz \text{ to } 100kHz, V_{IN} = V_{OUT} + 1V$	$V_{OUT} = 0.8V$	--	38	--	$\mu V_{RMS}$
			$V_{OUT} = 1.2V$	--	46	--	
			$V_{OUT} = 1.8V$	--	48	--	
			$V_{OUT} = 3.3V$	--	51	--	
Output Current Limit	$I_{LIM}$	$V_{OUT} = 90\% \text{ of } V_{OUT(NOM)}$	350	600	--	mA	
Enable Threshold Voltage	H-Level	$V_{ENH}$	$V_{IN} = 5V$	0.5	0.7	0.9	V
	L-Level	$V_{ENL}$	$V_{IN} = 5V$	0.4	0.65	0.85	
Thermal Shutdown Temperature	$T_{SD}$	$I_{LOAD} = 30mA, V_{IN} \geq 1.5V$	--	150	--	$^{\circ}C$	
Thermal Shutdown Hysteresis	$\Delta T_{SD}$		--	20	--	$^{\circ}C$	
Discharge Resistance		$EN = 0V, V_{OUT} = 0.1V$	--	80	--	$\Omega$	

## TYPICAL APPLICATION

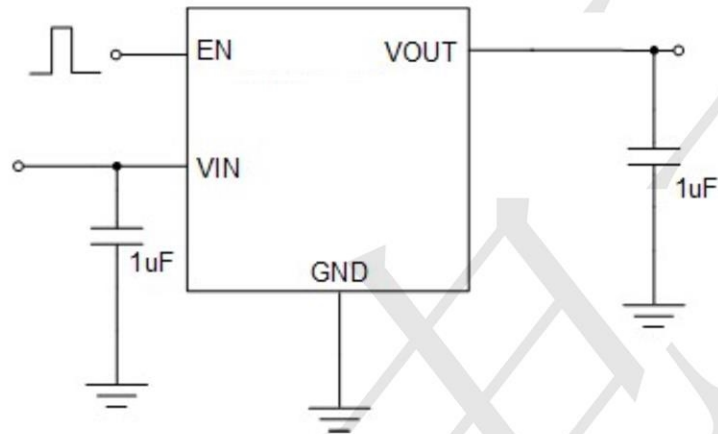

Application circuit of Fixed V<sub>OUT</sub> LDO with enable function

**Typical Operating Characteristics**

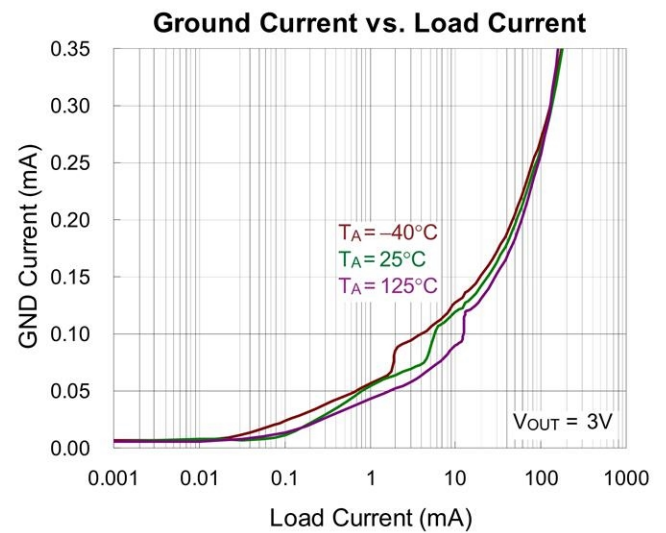
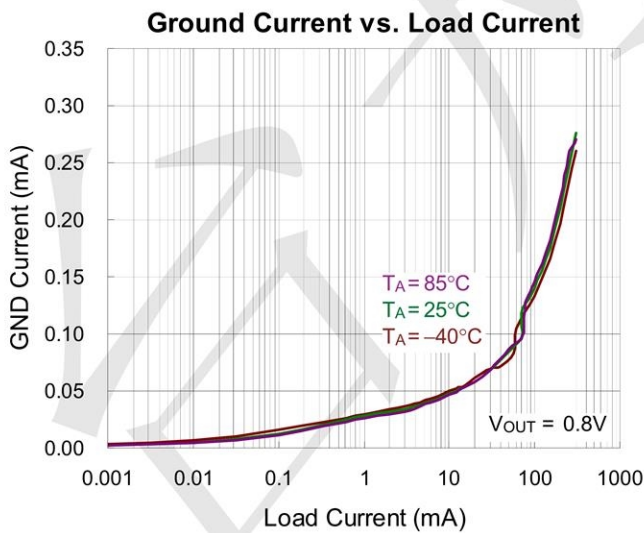
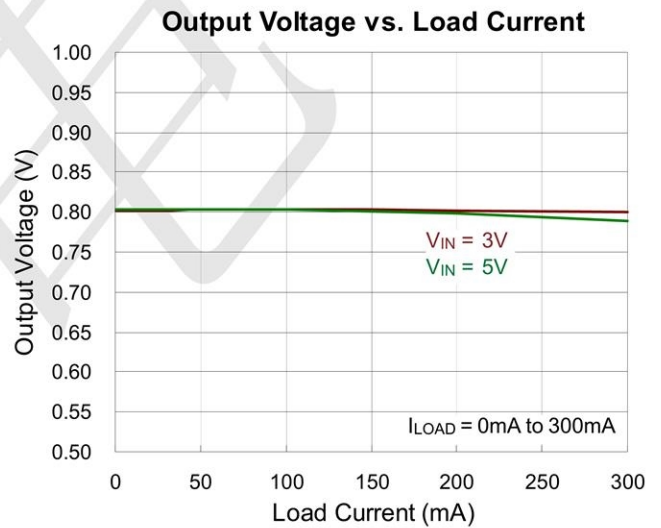
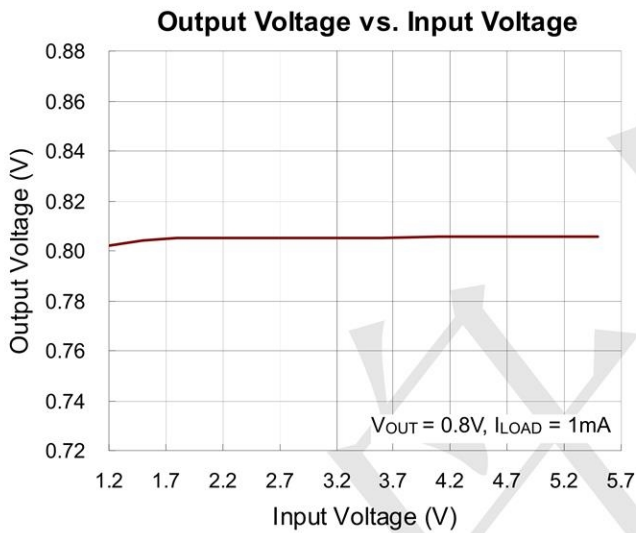
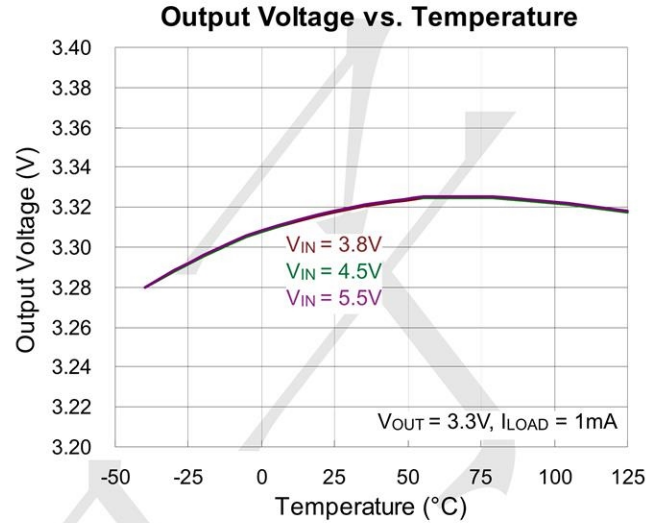
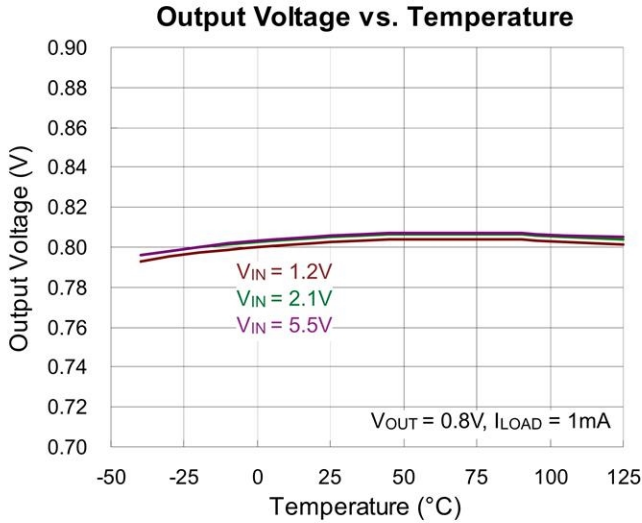

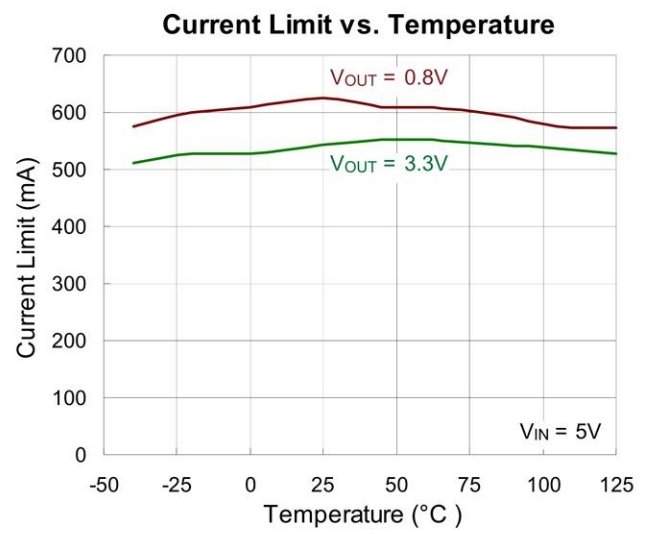
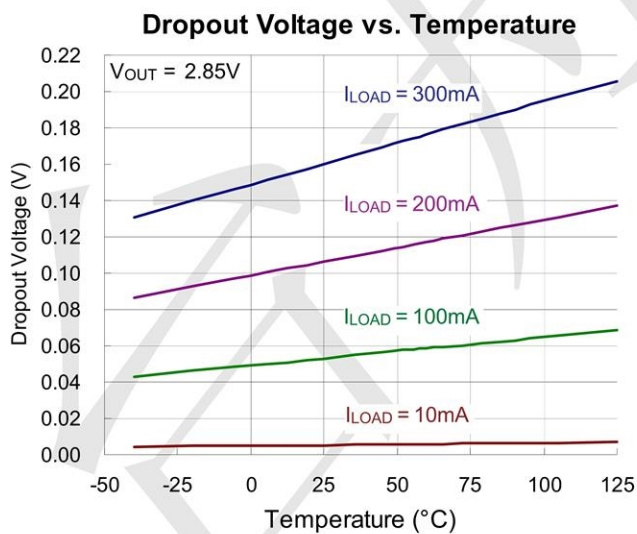
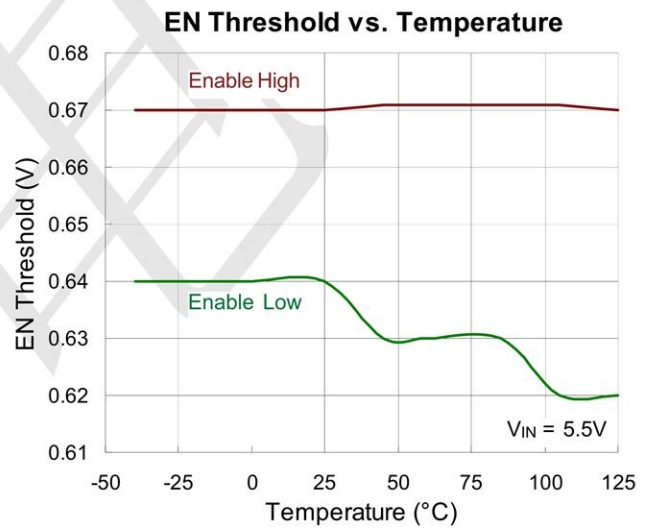
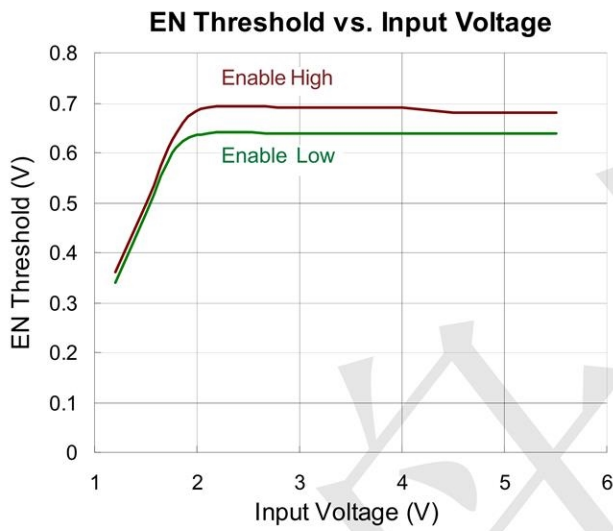
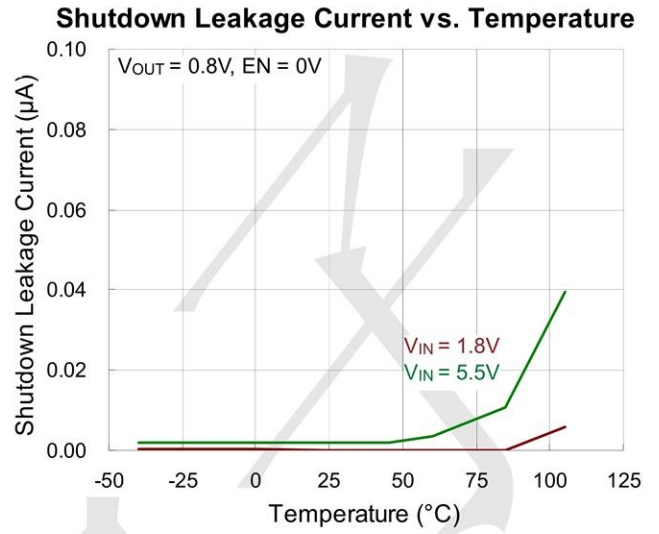
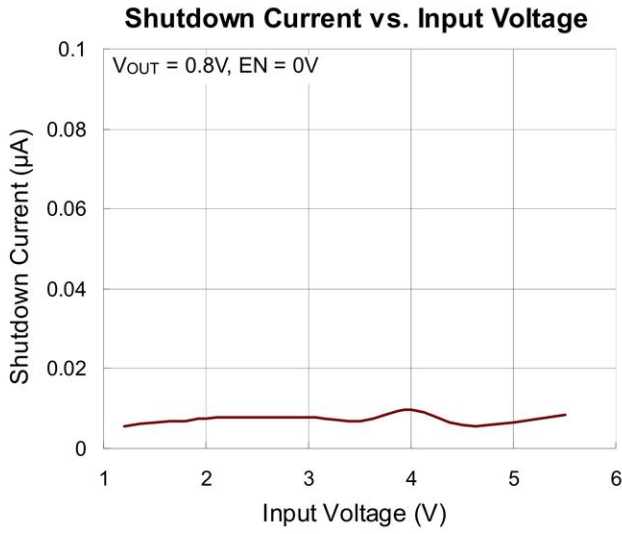



Fold-Back Current Limit vs. Temperature

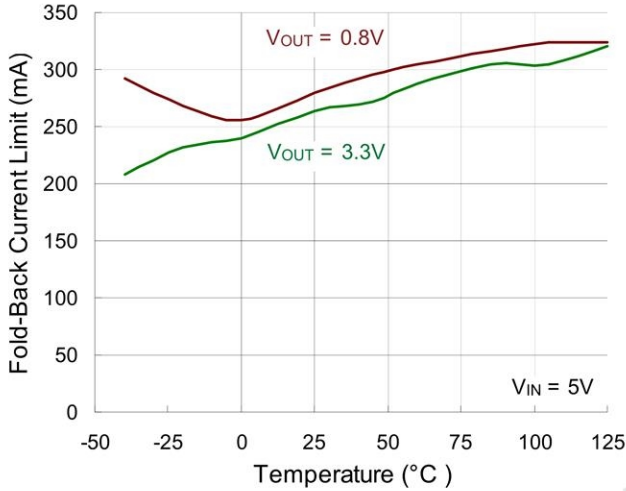

SNS Input Current vs. Temperature

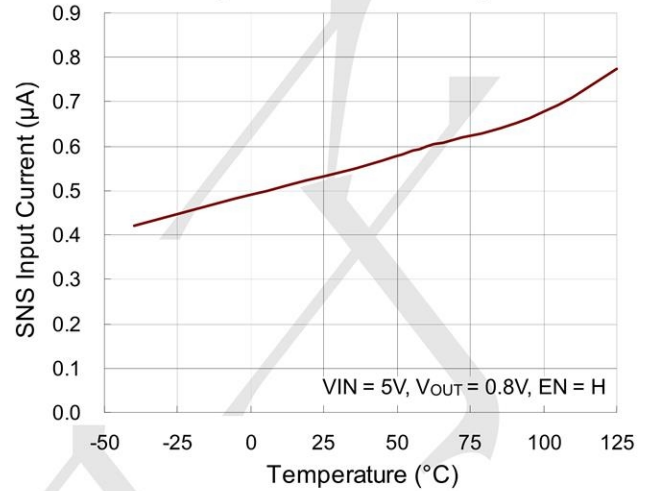

Power On from EN

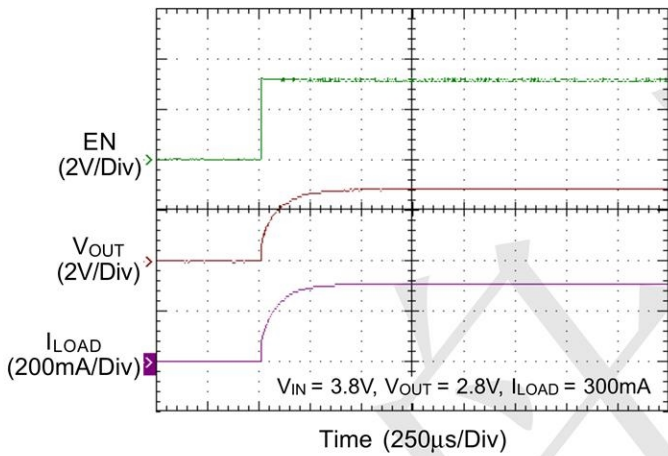

Power Off from EN

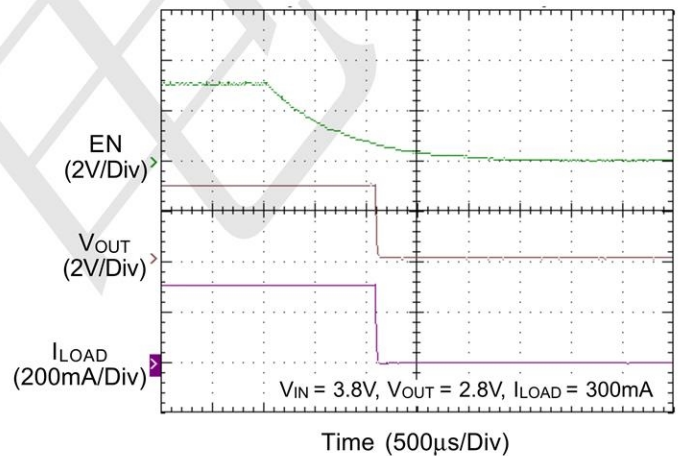

Line Transient

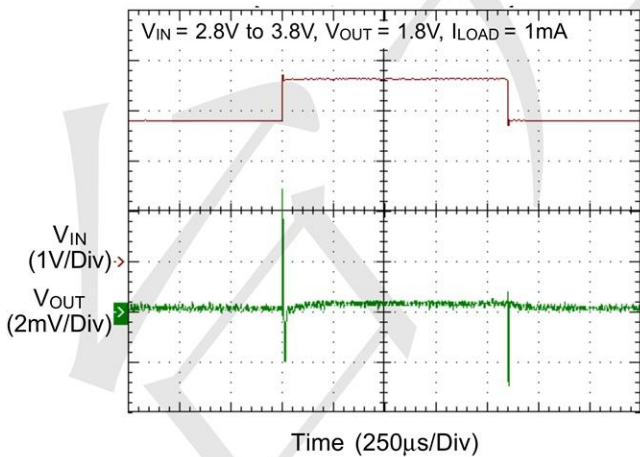

Load Transient

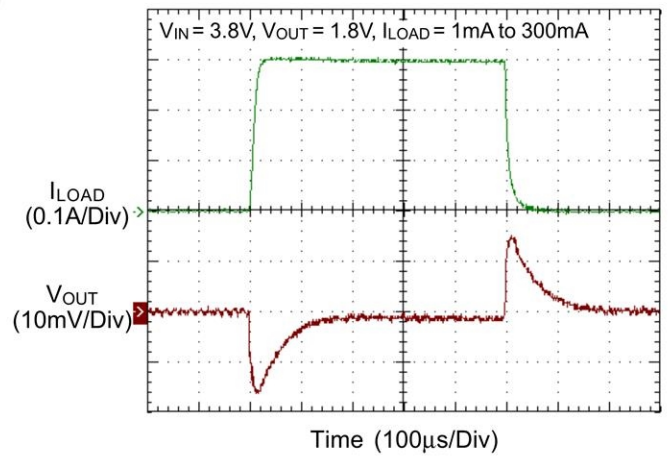



**Output Current Limit Protection**

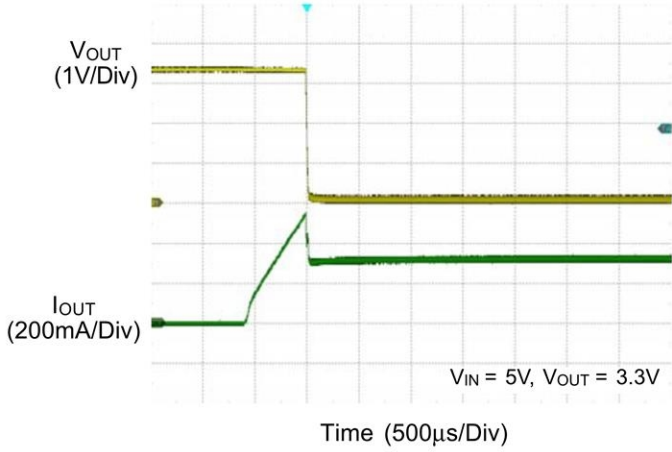

**PSRR vs. Frequency**

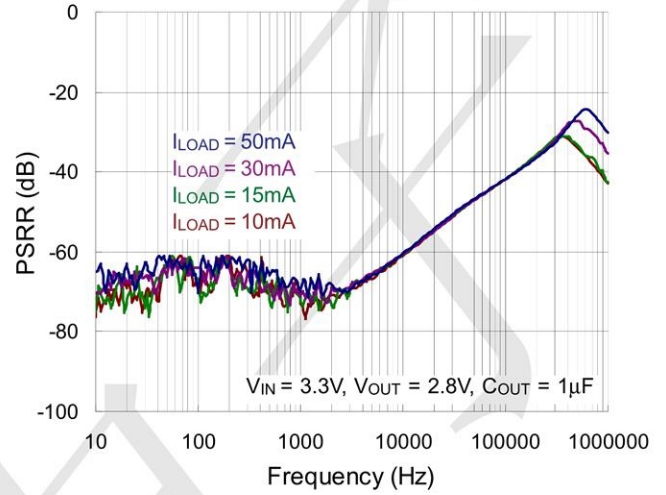

**PSRR vs. Frequency**

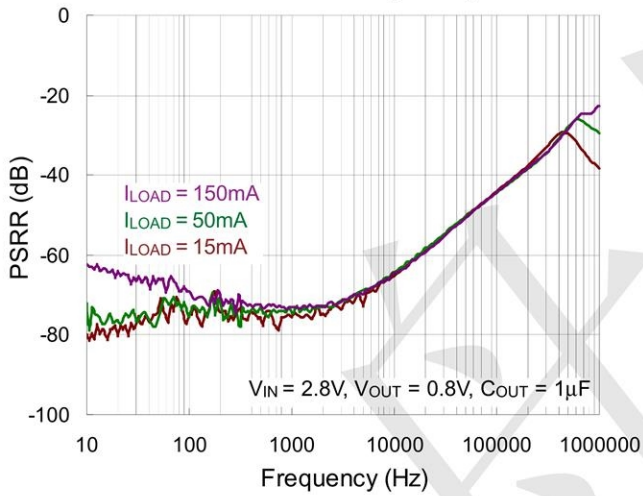

**Output Noise vs. Frequency**

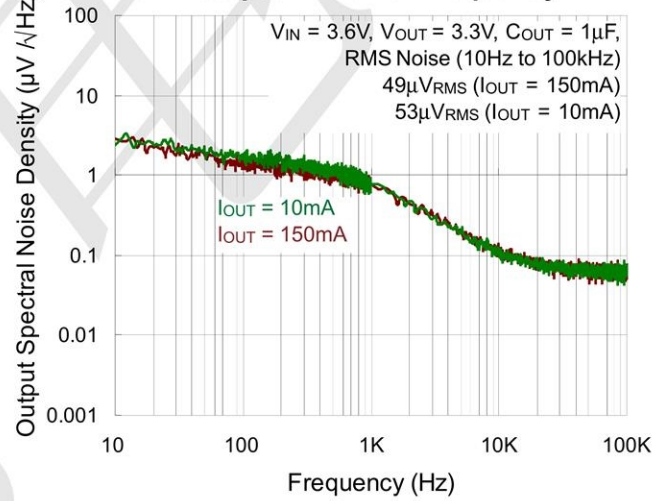



Package informantion

3-pin SOT23-5 Outline Dimensions

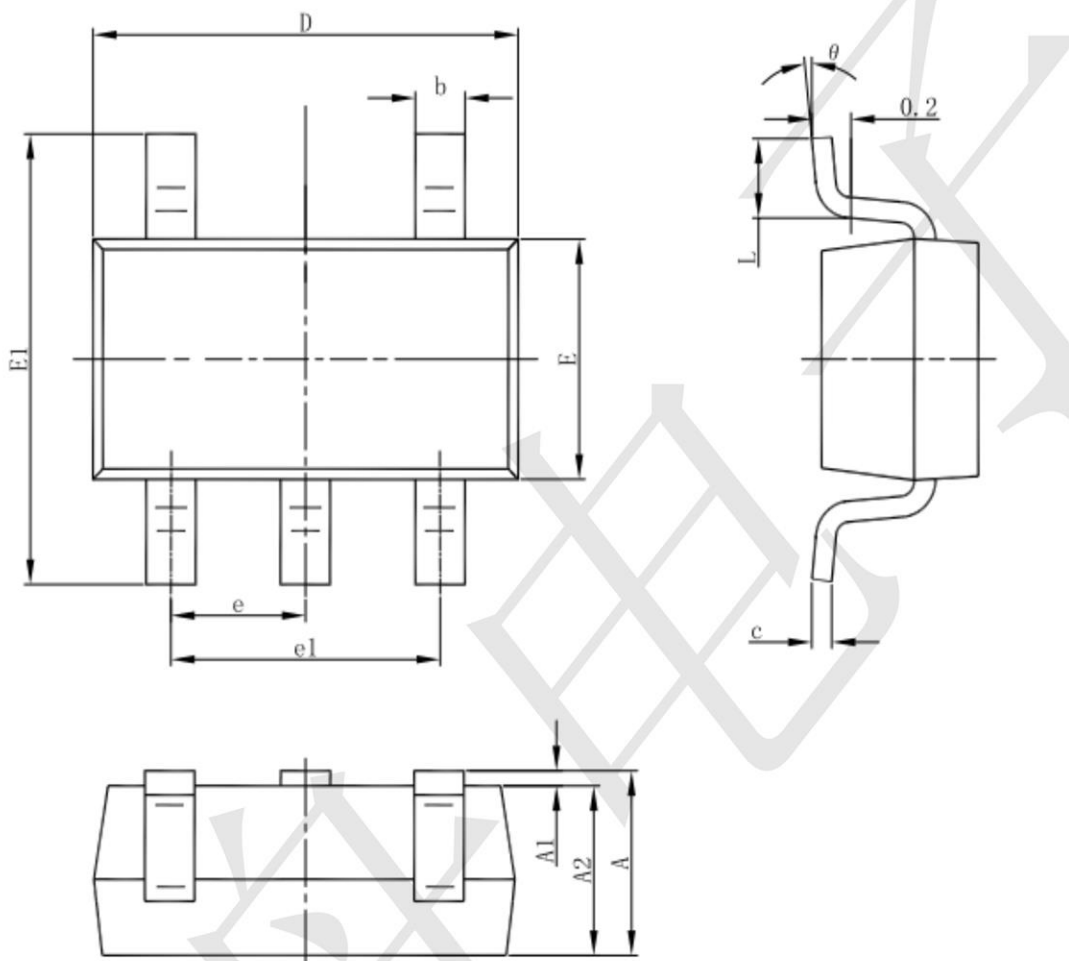

Symbol	Dimensions In Millimeters		Dimensions In Inches	
	Min	Max	Min	Max
A	1.050	1.250	0.041	0.049
A1	0.000	0.100	0.000	0.004
A2	1.050	1.150	0.041	0.045
b	0.300	0.500	0.012	0.020
c	0.100	0.200	0.004	0.008
D	2.820	3.020	0.111	0.119
E	1.500	1.700	0.059	0.067
E1	2.650	2.950	0.104	0.116
e	0.950(BSC)		0.037(BSC)	
e1	1.800	2.000	0.071	0.079
L	0.300	0.600	0.012	0.024
theta	0°	8°	0°	8°