

### Features

- 2μA Ground Current at no Load
- ±2% Output Accuracy
- 300mA Output Current
- Wide Operating Input Voltage Range: 2V to 24V
- Dropout Voltage: 0.35V at 100mA ( $V_{OUT}=5V$ )
- Support Fixed Output Voltage 1.8V, 3.3V, 5V,
- Stable with Ceramic or Tantalum Capacitor
- Current Limit Protection
- Over-Temperature Protection
- SOT-23-5 Package Available
- LP2992IM5X-3.3 Pin to Pin Fully Compatible

### Applications

- Portable, Battery Powered Equipment
- Low Power Microcontrollers
- Laptop, Palmtops and PDAs
- Wireless Communication Equipment
- Audio/Video Equipment
- Car Navigation Systems
- Industrial Controls
- Weighting Scales
- Meters
- Home Automation

### General Description

The Devices is a low-dropout (LDO) voltage regulators with enable function offering the benefits of high input voltage, low-dropout voltage, low-power consumption, and miniaturized packaging.

The features of low quiescent current as low as 2.0μA and zero disable current is ideal for powering the battery equipment to a longer service life. The Devices

is stable with the ceramic output capacitor over its wide input range from 2V to 24V and the entire range of output load current.

### Ordering Information

#### TPLP2992IM5X-3.3

Output voltage: 3.3=3.3V  
5.0=5.0V  
1.8=1.8V

TPLP2992IM5X-3.3

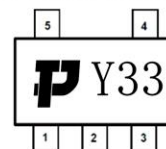

TPLP2992IM5X-5.0

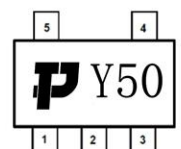

TPLP2992IM5X-1.8

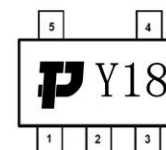

## PIN CONFIGURATION

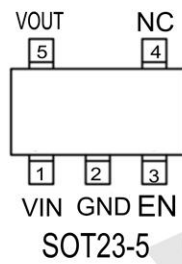

Pin No	Pin Name	Pin Function
1	VIN	Input of Supply Voltage.
2	GND	Ground
3	EN	Enable Control Input.
4	NC	No Internal Connection.
5	VOUT	Output of the Regulator

**BLOCK DIAGRAM**

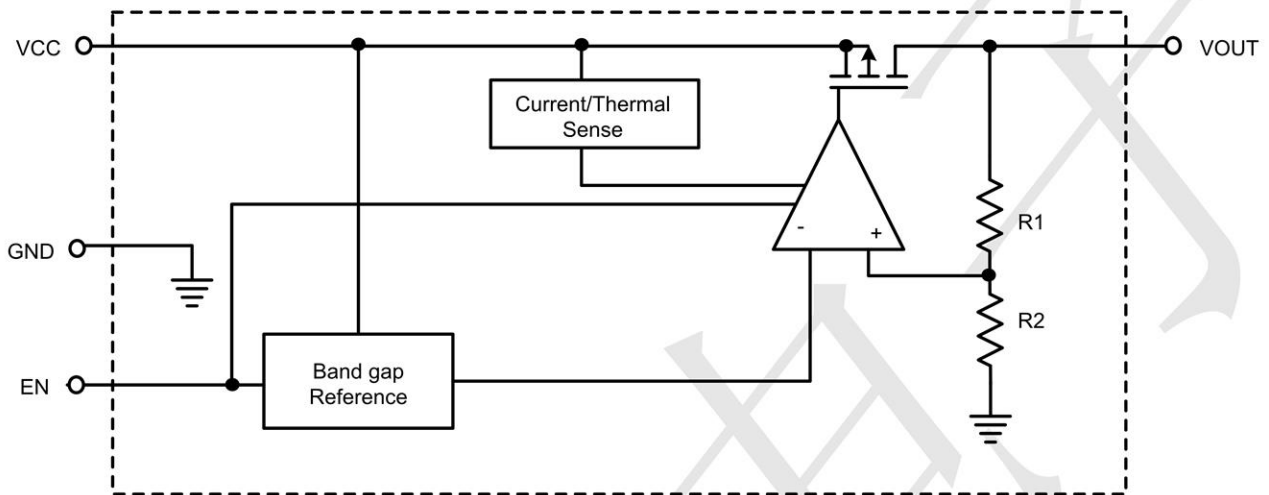

**Absolute Maximum Ratings**

VIN Pin to GND Pin Voltage .....	-0.3V to 25V
VOUT Pin to GND Pin Voltage .....	-0.3V to 6.0V
VOUT Pin to VIN Pin Voltage .....	-25V to 0.3V
Package Thermal Resistance (Note 2)	
SOT-23-5, SOT-23-3, $\theta_{JA}$ .....	200 °C /W
Lead Temperature (Soldering, 10 sec.) .....	260 °C
Junction Temperature .....	150 °C
Storage Temperature Range .....	-40 °C to 150 °C
ESD Susceptibility	
HBM .....	2KV
MM .....	200V

**Recommended Operating Conditions**

Supply Input Voltage .....	-2.0V to 24V
Junction Temperature Range .....	-40 °C to 125 °C
Ambient Temperature Range .....	-40 °C to 85 °C

### Electrical Characteristics

( $V_{IN}=15V$ ,  $V_{EN}=5V$ ,  $T_A=25^{\circ}C$ , unless otherwise specified) (Note 1)

Parameter	Symbol	Test Conditions	Min	Typ	Max	Unit
Supply Voltage	$V_{IN}$		2	--	24	V
DC Output Voltage Accuracy		$I_{LOAD} = 0.1mA$	-2		2	%
Dropout Voltage ( $I_{LOAD} = 100mA$ )	$V_{DROP}$	$V_{OUT} \geq 5V$	--	0.35		V
	$V_{DROP\_3.3V}$	$V_{OUT} = 3.3V$		0.42		
	$V_{DROP\_1.8V}$	$V_{OUT} = 1.8V$		0.5		
Ground Current ( $I_{LOAD} = 0mA$ )	$I_Q$	$V_{OUT} \leq 5V$		2.0	4.5	$\mu A$
Shutdown Ground Current	$I_{SD}$	$V_{EN} = 0V$ , $V_{OUT} = 0V$		0.01	0.5	$\mu A$
$V_{OUT}$ Shutdown Leakage Current	$I_{LEAK}$			0.01	0.5	$\mu A$
Enable Threshold Voltage	$V_{IH}$	EN Rising	1.1			V
	$V_{IL}$	EN Falling			0.4	
EN Input Current	$I_{EN}$	$V_{EN} = 27V$		10	100	nA
Line Regulation	$\Delta LINE$	$I_{LOAD} = 1mA$ , $10 \leq V_{IN} \leq 20V$	--	0.3		%
Load Regulation	$\Delta LOAD$	$10mA \leq I_{LOAD} \leq 0.2A$		0.3		%
Output Current Limit	$I_{LIM}$	$V_{OUT} = 0$	300	500		mA
Power Supply Rejection Ratio	PSRR	$V_{OUT} = 5V$ , $I_{LOAD} = 30mA$ , $V_{IN} = 12V$ , $f = 1kHz$		70		dB
Thermal Shutdown Temperature	$T_{SD}$	$I_{LOAD} = 10mA$	--	160	--	$^{\circ}C$
Thermal Shutdown Hysteresis	$\Delta T_{SD}$				15	$^{\circ}C$

**Typical Operating Characteristics**

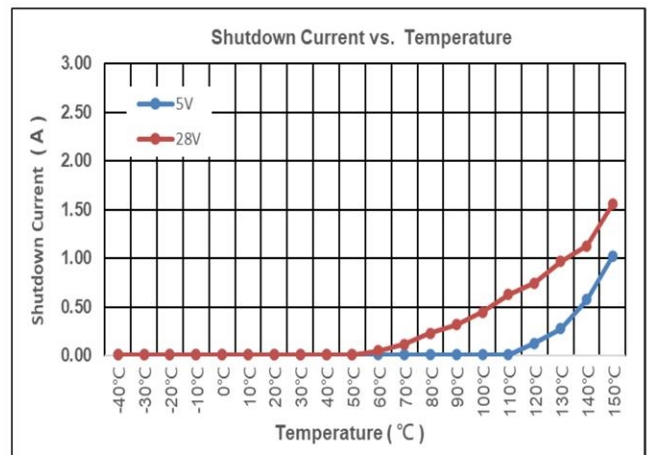
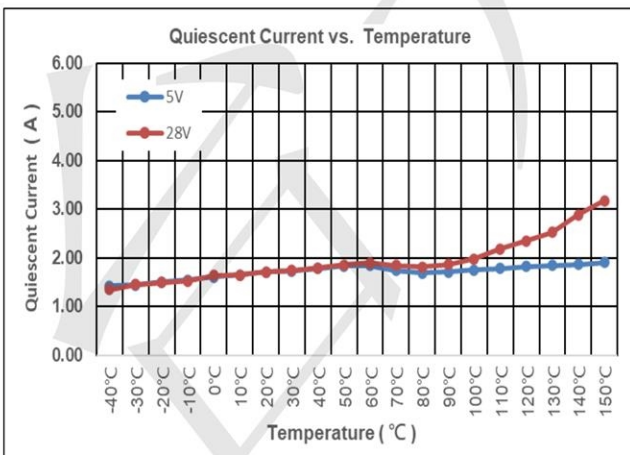
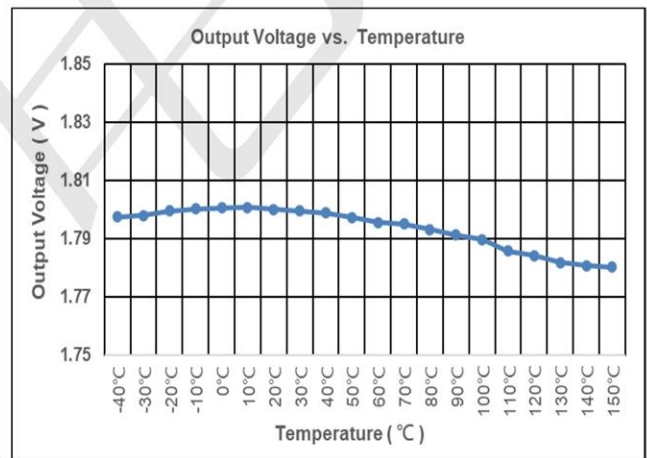
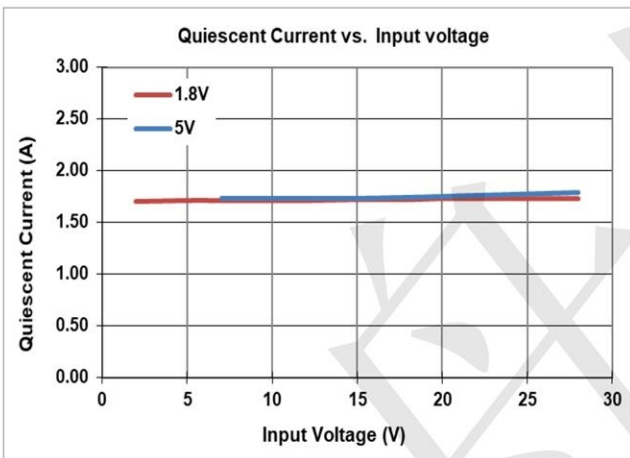
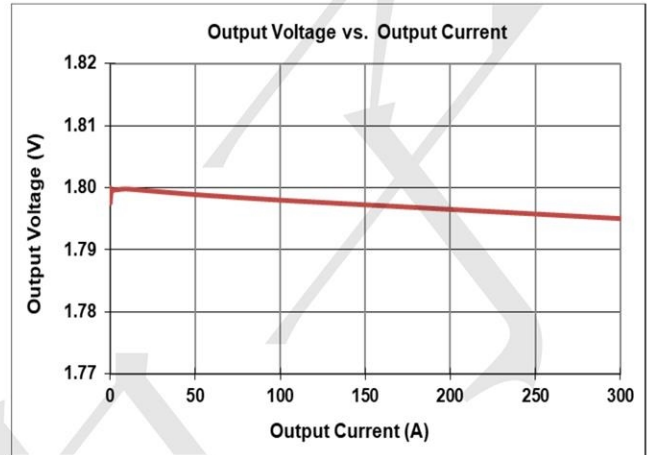
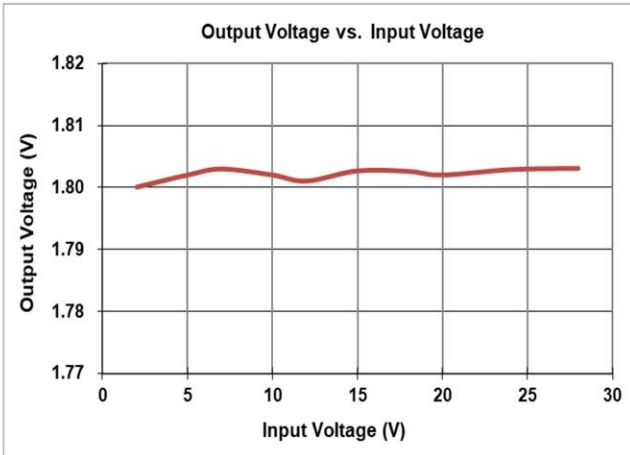

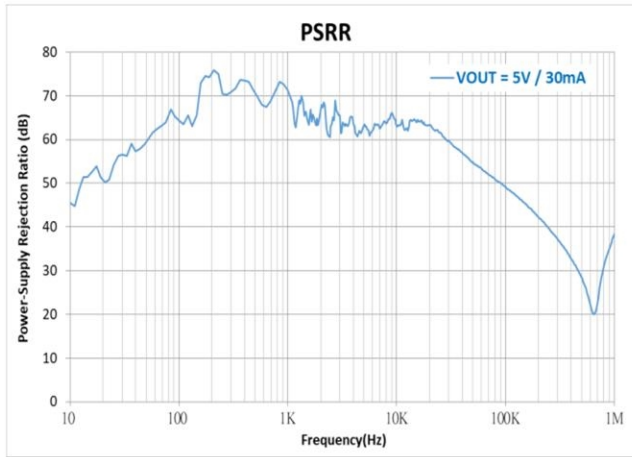

### Typical Application Circuit

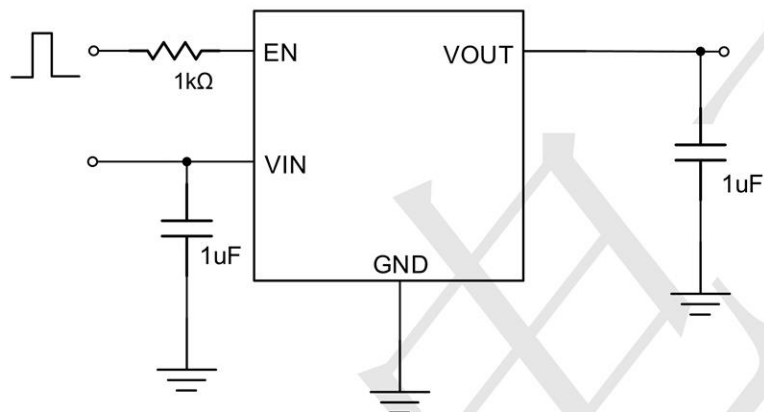

Figure 1: Application circuit of Fixed VOUT LDO with enable function



TECH PUBLIC

—台丹电子—

TPLP2992IM5X-3.3

24V ,300mA,2uA, Higt PSRR Voltage Reaulator

www.sot23.com.tw

Package informantion

SOT23-5

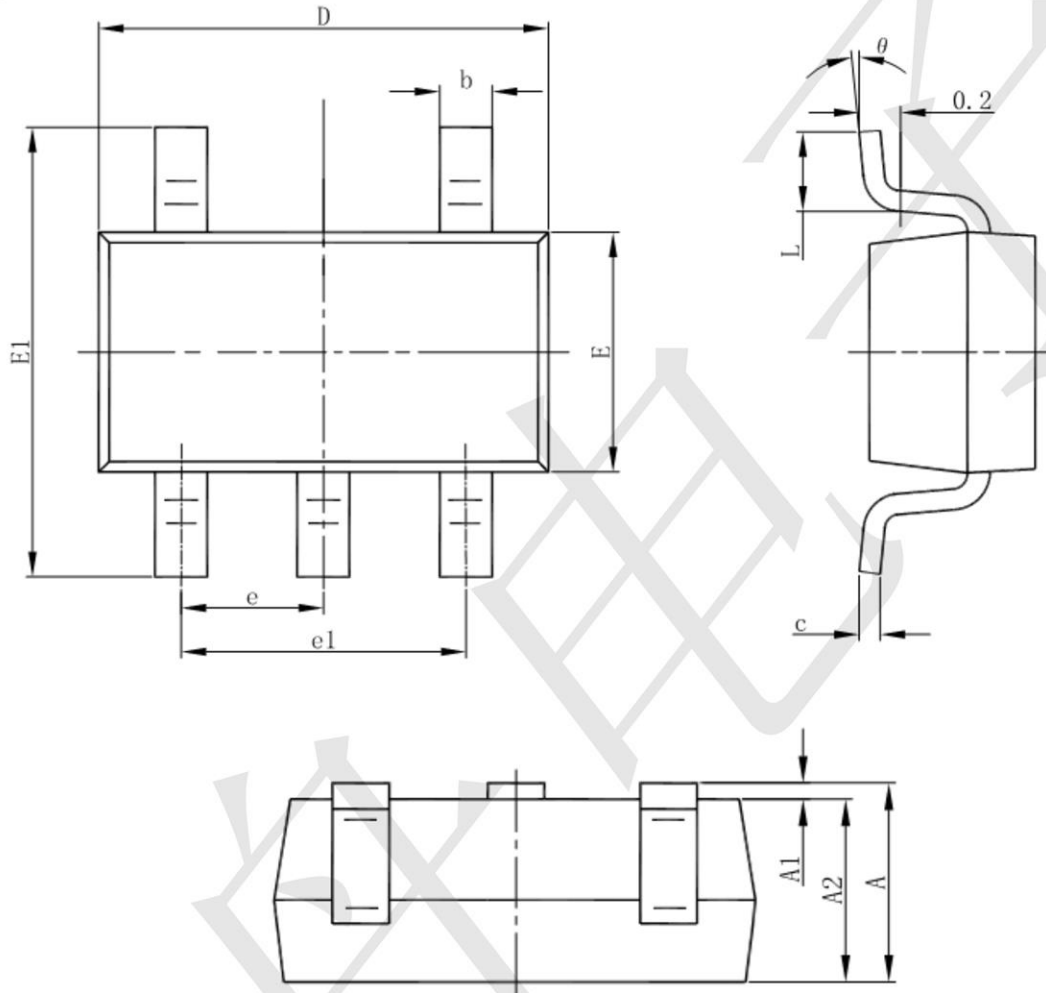

Symbol	Dimensions In Millimeters		Dimensions In Inches	
	Min	Max	Min	Max
A	1.050	1.250	0.041	0.049
A1	0.000	0.100	0.000	0.004
A2	1.050	1.150	0.041	0.045
b	0.300	0.500	0.012	0.020
c	0.100	0.200	0.004	0.008
D	2.820	3.020	0.111	0.119
E	1.500	1.700	0.059	0.067
E1	2.650	2.950	0.104	0.116
e	0.950(BSC)		0.037(BSC)	
e1	1.800	2.000	0.071	0.079
L	0.300	0.600	0.012	0.024
theta	0°	8°	0°	8°

WWW.TECHPUBLIC.COM.TW