

# Low Quiescent Current Power Distribution Switch

## 1 FEATURES

- **Ultra-Low On Resistance ( $R_{ON}$ )**  
 $R_{ON} = 24m\Omega$  at  $V_{IN}=5V$  ( $V_{BIAS} = 5V$ )
- **Input Voltage ( $V_{IN}$ ) from 0.8V to 5.5V**
- **Supply Voltage ( $V_{BIAS}$ ) from 2.5V to 5.5V**
- **Low Quiescent Current :35 $\mu$ A (TYP) at  $V_{BIAS} = V_{IN} = 5V$**
- **6A Maximum Continuous Switch Current**
- **Low Control Input Threshold Enables Use of 1.2V, 1.8V, 2.5V, and 3.3V Logic**
- **Quick Output Discharge**
- **Configurable Rise Time**
- **Lead-Free Packages: DFN2x2-8L**

## 2 APPLICATIONS

- Tablet PC
- Notebooks and Netbooks
- Solid State Drivers
- Telecom Systems
- Set-top Boxes

## 3 DESCRIPTION

The RS2580 is a single channel load switch that provides configurable rise time to minimize inrush current. The device contains an N-channel MOSFET that can operate over an input voltage range of 0.8V to 5.5V and can support a maximum continuous current of 6 A.

The switch is controlled by an on and off input (ON), which is capable of interfacing directly with low-voltage control signals. In the RS2580, a 220 $\Omega$  on-chip load resistor is added for quick output discharge when switch is turned off.

The RS2580 is available in DFN2x2-8L package with integrated thermal pad allowing for high power dissipation.

The device is characterized for operation over the free-air temperature range of -40 $^{\circ}$ C to +105 $^{\circ}$ C.

**Device Information (1)**

PART NUMBER	PACKAGE	BODY SIZE (NOM)
RS2580	DFN2x2-8L(8)	2.00mmx2.00mm

(1) For all available packages, see the orderable addendum at the end of the data sheet.

## 4 Typical Application Circuit

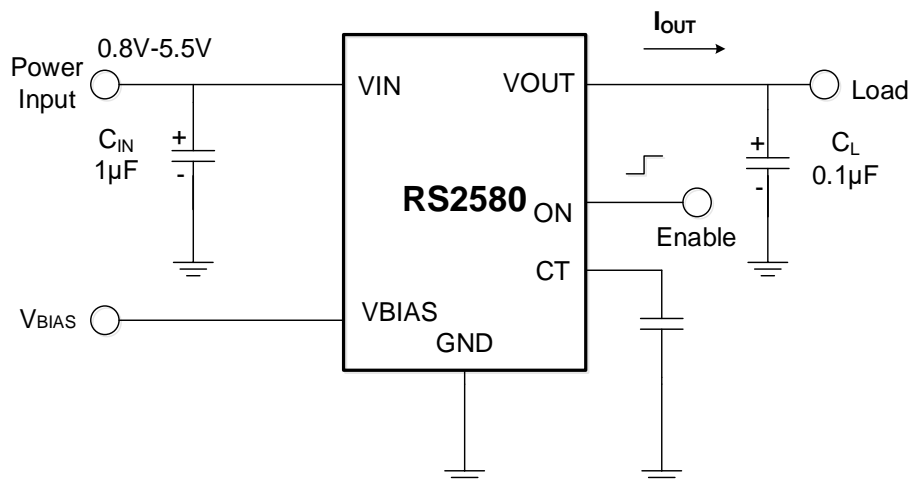

### 5 Functional Block Diagram

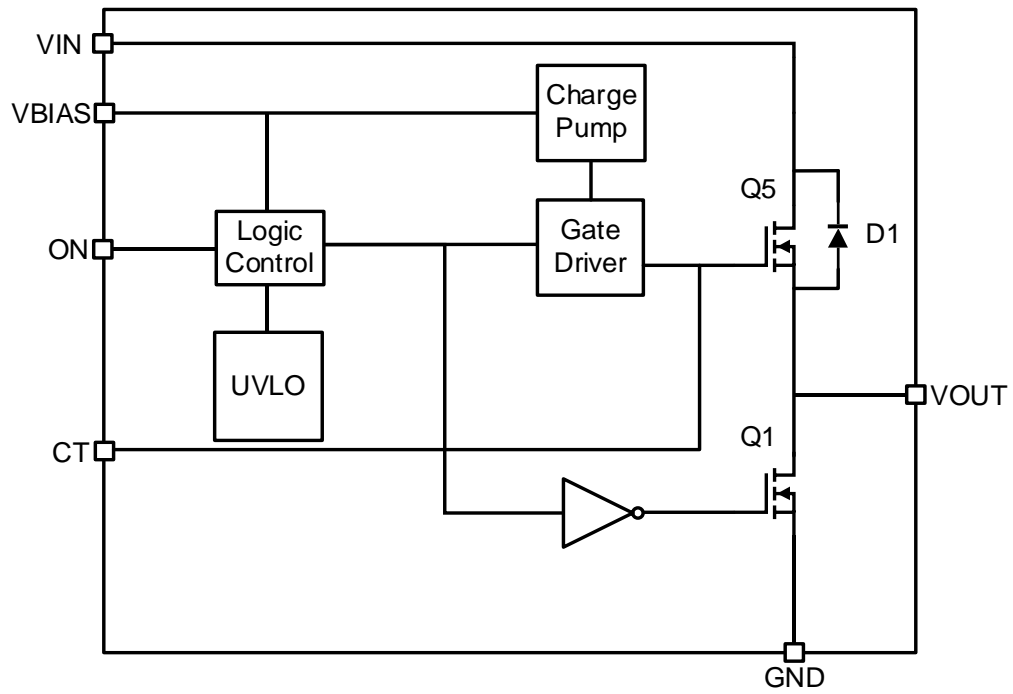

## Table of Contents

<b>1 FEATURES</b> .....	1
<b>2 APPLICATIONS</b> .....	1
<b>3 DESCRIPTION</b> .....	1
<b>4 Typical Application Circuit</b> .....	1
<b>5 Functional Block Diagram</b> .....	2
<b>6 Revision History</b> .....	4
<b>7 PACKAGE/ORDERING INFORMATION</b> .....	5
<b>8 PIN CONFIGURATIONS</b> .....	6
<b>9 SPECIFICATIONS</b> .....	7
9.1 Absolute Maximum Ratings .....	7
9.2 ESD Ratings.....	7
9.3 Recommended Operating Conditions.....	7
9.4 Thermal Information .....	7
9.5 Electrical Characteristics.....	8
9.6 Switching Characteristics.....	10
9.7 PARAMETER MEASUREMENT INFORMATION .....	13
9.8 Typical Performance Characteristics .....	14
<b>10 FUNCTIONAL DESCRIPTION</b> .....	20
10.1 Overview .....	20
10.2 BIAS Under-voltage Lockout (UVLO) .....	20
10.3 Soft-Start .....	20
10.4 Enable Control .....	20
10.5 Turn-On & Turn-off the device .....	20
10.6 Supply filter capacitor.....	20
10.7 Adjustable Rise Time .....	20
10.8 Inrush Current .....	21
10.9 Power dissipation .....	21
<b>11 Layout</b> .....	22
11.1 Layout Guidelines .....	22
11.2 Layout Example .....	22
<b>12 PACKAGE OUTLINE DIMENSIONS</b> .....	23
<b>13 TAPE AND REEL INFORMATION</b> .....	24

## 6 Revision History

Note: Page numbers for previous revisions may differ from page numbers in the current version.

VERSION	Change Date	Change Item
A.0	2022/04/18	Initial version completed
A.1	2022/06/16	Official version completed

**7 PACKAGE/ORDERING INFORMATION**

PRODUCT	ORDERING NUMBER	TEMPERATURE RANGE	PACKAGE LEAD	PACKAGE MARKING <sup>(1)</sup>	PACKAGE OPTION
RS2580	RS2580XTDE8	-40°C ~+105°C	DFN2x2-8L	2580	Tape and Reel,3000

NOTE:

- (1) There may be additional marking, which relates to the lot trace code information(include data code and vendor code), the logo or the environmental category on the device.

## 8 PIN CONFIGURATIONS

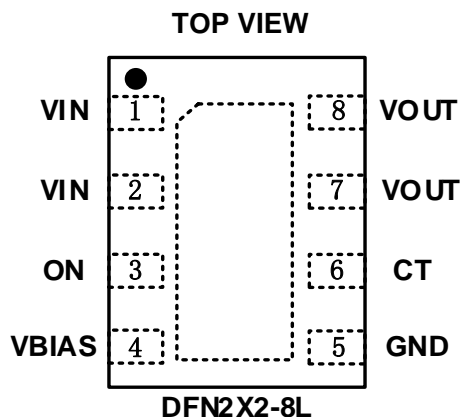

PIN	NAME	TYPE	DESCRIPTION
DFN2x2-8L			
1,2	VIN	I	Switch input. Input bypass capacitor recommended for minimizing VIN dip. Must be connected to Pin 1 and Pin 2.
3	ON	I	Active high switch control input. Must do not leave floating.
4	VBIAS	I	Bias voltage. Power supply to the device. Recommended voltage range for this pin is 2.5V to 5.5V.
5	GND	--	Ground.
6	CT	O	Switch slew rate control. Can be left floating.
7,8	VOUT	O	Switch output. Must be connected to Pin 7 and Pin 8.
--	Thermal Pad	--	Thermal pad (exposed center pad) to alleviate thermal stress. Tie to GND.

## 9 SPECIFICATIONS

### 9.1 Absolute Maximum Ratings

over operating free-air temperature range (unless otherwise noted) <sup>(1)(2)</sup>

Characteristics	Symbol	MIN	MAX	UNIT
$V_{IN}/V_{BIAS}/V_{ON}/V_{OUT}$ Input Voltage		-0.3	6.0	V
Maximum continuous switch current	$I_{MAX}$		6	A
Maximum pulsed switch current, pulse < 300 $\mu$ s, 2% duty cycle	$I_{PLS}$		8	A
Operating Junction Temperature	$T_{opr}$	-40	+125	$^{\circ}$ C
Storage Temperature	$T_{stg}$	-65	+150	$^{\circ}$ C
Lead Temperature (Soldering, 10secs)			260	$^{\circ}$ C

(1) Stresses beyond those listed under *Absolute Maximum Ratings* may cause permanent damage to the device. These are stress ratings only, and functional operation of the device at these or any other conditions beyond those indicated under *Recommended Operating Conditions* is not implied. Exposure to absolute-maximum-rated conditions for extended periods may affect device reliability.

(2) All voltages are with respect to the GND pin.

### 9.2 ESD Ratings

		VALUE	UNIT
$V_{(ESD)}$ Electrostatic discharge	Human-body model (HBM)	$\pm 2000$	V
	Charge device model (CDM)	$\pm 1500$	V

### 9.3 Recommended Operating Conditions

over operating free-air temperature range (unless otherwise noted)

Characteristics	Symbol	MIN	MAX	UNIT
Input Voltage	$V_{IN}$	0.8	$V_{BIAS}$	V
Bias Voltage	$V_{BIAS}$	2.5	5.5	V
ON Voltage range	$V_{ON}$	0	5.5	V
Output Voltage	$V_{OUT}$		$V_{IN}$	V
Input Capacitor	$C_{IN}$	1		$\mu$ F
Operating Temperature Range	$T_A$	-40	+105	$^{\circ}$ C

### 9.4 Thermal Information

THERMAL METRIC		RS2580	UNIT
		DFN2x2-8L	
		8 PINS	
$R_{\theta JA}$	Junction-to-ambient thermal resistance	80.1	$^{\circ}$ C/W
$R_{\theta JC(top)}$	Junction-to-case (top) thermal resistance	100	$^{\circ}$ C/W
$R_{\theta JB}$	Junction-to-board thermal resistance	45	$^{\circ}$ C/W
$\psi_{JT}$	Junction-to-top characterization parameter	6.8	$^{\circ}$ C/W
$\psi_{JB}$	Junction-to-board characterization parameter	45.2	$^{\circ}$ C/W
$R_{JC(bot)}$	Junction-to-case (bottom) thermal resistance	22.7	$^{\circ}$ C/W
$P_d$	Power Dissipation	1.25	W

## 9.5 Electrical Characteristics

(At  $V_{IN}=V_{BIAS}=2.5V$ ,  $T_A = +25^{\circ}C$ , unless otherwise noted.)

PARAMETER	SYMBOL	CONDITIONS		TEMP	MIN	TYP	MAX	UNIT
Input Voltage	$V_{IN}$				0.8		5.5	V
Bias Input Voltage	$V_{BIAS}$				2.5		5.5	V
Bias supply current	$I_{BIAS}$	Switch on, $V_{OUT} = \text{open}$		$-40^{\circ}C$ to $+105^{\circ}C$		30	40	$\mu A$
Bias supply current at Shutdown	$I_{BIAS\_SD}$	Switch off, $V_{OUT} = \text{open}$		$-40^{\circ}C$ to $+105^{\circ}C$		0.01	1.0	$\mu A$
$V_{IN}$ off-state supply current	$I_{VIN\_SD}$	Switch off, $V_{IN}=2.5V$ , $V_{OUT} = \text{open}$		$-40^{\circ}C$ to $+105^{\circ}C$		0.01	10	$\mu A$
		Switch off, $V_{IN}=1.8V$ , $V_{OUT} = \text{open}$		$-40^{\circ}C$ to $+105^{\circ}C$		0.01	10	
		Switch off, $V_{IN}=1.2V$ , $V_{OUT} = \text{open}$		$-40^{\circ}C$ to $+105^{\circ}C$		0.01	10	
		Switch off, $V_{IN}=0.8V$ , $V_{OUT} = \text{open}$		$-40^{\circ}C$ to $+105^{\circ}C$		0.01	10	
ON pin input leakage current	$I_{ON}$	$V_{ON}=5.5V$		$-40^{\circ}C$ to $+105^{\circ}C$		0.01	1.0	$\mu A$
Enable input threshold	$V_{IL}$	$V_{BIAS} = 2.5V$		$-40^{\circ}C$ to $+105^{\circ}C$			0.4	V
	$V_{IH}$	$V_{BIAS} = 2.5V$		$-40^{\circ}C$ to $+105^{\circ}C$	1.2			V
Switch resistance	$R_{DS(ON)}$	$I_{OUT} = 200mA$ (Include bonding wire)		$V_{IN}=2.5V$	25 $^{\circ}C$		28	m $\Omega$
					$-40^{\circ}C$ to $+85^{\circ}C$		38	
					$-40^{\circ}C$ to $+105^{\circ}C$		40	
				$V_{IN}=1.8V$	25 $^{\circ}C$		26	
					$-40^{\circ}C$ to $+85^{\circ}C$		34	
					$-40^{\circ}C$ to $+105^{\circ}C$		36	
				$V_{IN}=1.5V$	25 $^{\circ}C$		25	
					$-40^{\circ}C$ to $+85^{\circ}C$		34	
					$-40^{\circ}C$ to $+105^{\circ}C$		36	
				$V_{IN}=1.2V$	25 $^{\circ}C$		25	
					$-40^{\circ}C$ to $+85^{\circ}C$		33	
					$-40^{\circ}C$ to $+105^{\circ}C$		35	
$V_{IN}=0.8V$	25 $^{\circ}C$		24					
	$-40^{\circ}C$ to $+85^{\circ}C$		32					
	$-40^{\circ}C$ to $+105^{\circ}C$		34					
$V_{OUT}$ shutdown discharge resistance	$R_{DIS}$	$V_{ON} = 0V$ , $I_{OUT} = 1mA$		25 $^{\circ}C$		220	330	$\Omega$



## Electrical Characteristics

(At  $V_{IN}=V_{BIAS}=5V$ ,  $T_A = +25^{\circ}C$ , unless otherwise noted.)

PARAMETER	SYMBOL	CONDITIONS		TEMP	MIN	TYP	MAX	UNIT
Input Voltage	$V_{IN}$				0.8		5.5	V
Bias Input Voltage	$V_{BIAS}$				2.5		5.5	V
Bias supply current	$I_{BIAS}$	Switch on, $V_{OUT} = \text{open}$		$-40^{\circ}C$ to $+105^{\circ}C$		35	45	$\mu A$
Bias supply current at Shutdown	$I_{BIAS\_SD}$	Switch off, $V_{OUT} = \text{open}$		$-40^{\circ}C$ to $+105^{\circ}C$		0.01	1.0	$\mu A$
$V_{IN}$ off-state supply current	$I_{VIN\_SD}$	Switch off, $V_{IN}=5V$ , $V_{OUT} = \text{open}$		$-40^{\circ}C$ to $+105^{\circ}C$		0.01	20	$\mu A$
		Switch off, $V_{IN}=3.3V$ , $V_{OUT} = \text{open}$		$-40^{\circ}C$ to $+105^{\circ}C$		0.01	15	
		Switch off, $V_{IN}=1.8V$ , $V_{OUT} = \text{open}$		$-40^{\circ}C$ to $+105^{\circ}C$		0.01	10	
		Switch off, $V_{IN}=0.8V$ , $V_{OUT} = \text{open}$		$-40^{\circ}C$ to $+105^{\circ}C$		0.01	10	
ON pin input leakage current	$I_{ON}$	$V_{ON}=5.5V$		$-40^{\circ}C$ to $+105^{\circ}C$		0.01	1.0	$\mu A$
Enable input threshold	$V_{IL}$	$V_{BIAS} = 5V$		$-40^{\circ}C$ to $+105^{\circ}C$			0.4	V
	$V_{IH}$	$V_{BIAS} = 5V$		$-40^{\circ}C$ to $+105^{\circ}C$	1.2			V
Switch resistance	$R_{DS(ON)}$	$I_{OUT} = 200mA$ (Include bonding wire)		$V_{IN}=5V$	25 $^{\circ}C$		24	m $\Omega$
					$-40^{\circ}C$ to $+85^{\circ}C$		32	
					$-40^{\circ}C$ to $+105^{\circ}C$		34	
				$V_{IN}=3.3V$	25 $^{\circ}C$		24	
					$-40^{\circ}C$ to $+85^{\circ}C$		32	
					$-40^{\circ}C$ to $+105^{\circ}C$		34	
				$V_{IN}=1.8V$	25 $^{\circ}C$		24	
					$-40^{\circ}C$ to $+85^{\circ}C$		32	
					$-40^{\circ}C$ to $+105^{\circ}C$		34	
				$V_{IN}=1.5V$	25 $^{\circ}C$		24	
					$-40^{\circ}C$ to $+85^{\circ}C$		32	
					$-40^{\circ}C$ to $+105^{\circ}C$		34	
				$V_{IN}=1.2V$	25 $^{\circ}C$		23	
					$-40^{\circ}C$ to $+85^{\circ}C$		31	
					$-40^{\circ}C$ to $+105^{\circ}C$		33	
				$V_{IN}=0.8V$	25 $^{\circ}C$		23	
$-40^{\circ}C$ to $+85^{\circ}C$		31						
$-40^{\circ}C$ to $+105^{\circ}C$		33						
$V_{OUT}$ shutdown discharge resistance	$R_{DIS}$	$V_{ON} = 0V$ , $I_{OUT} = 15mA$		25 $^{\circ}C$		195	300	$\Omega$

## 9.6 Switching Characteristics

PARAMETER	TEST CONDITIONS	MIN	TYP	MAX	UNIT
$V_{BIAS} = V_{ON} = V_{IN} = 5V, T_A=25^{\circ}C$ (unless otherwise noted)					
$t_{ON}$ Turn on time	$R_L = 10 \Omega, C_L = 0.1\mu F, C_T = 1000 pF$		1680		us
$t_{OFF}$ Turn off time	$R_L = 10 \Omega, C_L = 0.1\mu F, C_T = 1000 pF$		18		
$t_R$ $V_{OUT}$ rise time	$R_L = 10 \Omega, C_L = 0.1\mu F, C_T = 1000 pF$		2050		
$t_F$ $V_{OUT}$ fall time	$R_L = 10 \Omega, C_L = 0.1\mu F, C_T = 1000 pF$		11		
$t_D$ ON delay time	$R_L = 10 \Omega, C_L = 0.1\mu F, C_T = 1000 pF$		605		
$V_{BIAS} = V_{ON} = 5V, V_{IN} = 3.3V, T_A=25^{\circ}C$ (unless otherwise noted)					
$t_{ON}$ Turn on time	$R_L = 10 \Omega, C_L = 0.1\mu F, C_T = 1000 pF$		1240		us
$t_{OFF}$ Turn off time	$R_L = 10 \Omega, C_L = 0.1\mu F, C_T = 1000 pF$		20		
$t_R$ $V_{OUT}$ rise time	$R_L = 10 \Omega, C_L = 0.1\mu F, C_T = 1000 pF$		1395		
$t_F$ $V_{OUT}$ fall time	$R_L = 10 \Omega, C_L = 0.1\mu F, C_T = 1000 pF$		9		
$t_D$ ON delay time	$R_L = 10 \Omega, C_L = 0.1\mu F, C_T = 1000 pF$		510		
$V_{BIAS} = V_{ON} = 5V, V_{IN} = 2.5V, T_A=25^{\circ}C$ (unless otherwise noted)					
$t_{ON}$ Turn on time	$R_L = 10 \Omega, C_L = 0.1\mu F, C_T = 1000 pF$		1040		us
$t_{OFF}$ Turn off time	$R_L = 10 \Omega, C_L = 0.1\mu F, C_T = 1000 pF$		20		
$t_R$ $V_{OUT}$ rise time	$R_L = 10 \Omega, C_L = 0.1\mu F, C_T = 1000 pF$		1085		
$t_F$ $V_{OUT}$ fall time	$R_L = 10 \Omega, C_L = 0.1\mu F, C_T = 1000 pF$		8		
$t_D$ ON delay time	$R_L = 10 \Omega, C_L = 0.1\mu F, C_T = 1000 pF$		460		
$V_{BIAS} = V_{ON} = 5V, V_{IN} = 1.8V, T_A=25^{\circ}C$ (unless otherwise noted)					
$t_{ON}$ Turn on time	$R_L = 10 \Omega, C_L = 0.1\mu F, C_T = 1000 pF$		865		us
$t_{OFF}$ Turn off time	$R_L = 10 \Omega, C_L = 0.1\mu F, C_T = 1000 pF$		20		
$t_R$ $V_{OUT}$ rise time	$R_L = 10 \Omega, C_L = 0.1\mu F, C_T = 1000 pF$		790		
$t_F$ $V_{OUT}$ fall time	$R_L = 10 \Omega, C_L = 0.1\mu F, C_T = 1000 pF$		7		
$t_D$ ON delay time	$R_L = 10 \Omega, C_L = 0.1\mu F, C_T = 1000 pF$		455		
$V_{BIAS} = V_{ON} = 5V, V_{IN} = 1.5V, T_A=25^{\circ}C$ (unless otherwise noted)					
$t_{ON}$ Turn on time	$R_L = 10 \Omega, C_L = 0.1\mu F, C_T = 1000 pF$		785		us
$t_{OFF}$ Turn off time	$R_L = 10 \Omega, C_L = 0.1\mu F, C_T = 1000 pF$		21		
$t_R$ $V_{OUT}$ rise time	$R_L = 10 \Omega, C_L = 0.1\mu F, C_T = 1000 pF$		670		
$t_F$ $V_{OUT}$ fall time	$R_L = 10 \Omega, C_L = 0.1\mu F, C_T = 1000 pF$		6		
$t_D$ ON delay time	$R_L = 10 \Omega, C_L = 0.1\mu F, C_T = 1000 pF$		440		
$V_{BIAS} = V_{ON} = 5V, V_{IN} = 1.2V, T_A=25^{\circ}C$ (unless otherwise noted)					
$t_{ON}$ Turn on time	$R_L = 10 \Omega, C_L = 0.1\mu F, C_T = 1000 pF$		725		us
$t_{OFF}$ Turn off time	$R_L = 10 \Omega, C_L = 0.1\mu F, C_T = 1000 pF$		22		
$t_R$ $V_{OUT}$ rise time	$R_L = 10 \Omega, C_L = 0.1\mu F, C_T = 1000 pF$		570		
$t_F$ $V_{OUT}$ fall time	$R_L = 10 \Omega, C_L = 0.1\mu F, C_T = 1000 pF$		6		
$t_D$ ON delay time	$R_L = 10 \Omega, C_L = 0.1\mu F, C_T = 1000 pF$		420		
$V_{BIAS} = V_{ON} = 5V, V_{IN} = 0.8V, T_A=25^{\circ}C$ (unless otherwise noted)					

$t_{ON}$	Turn on time	$R_L = 10 \Omega, C_L = 0.1\mu F, C_T = 1000 \text{ pF}$		615		us
$t_{OFF}$	Turn off time	$R_L = 10 \Omega, C_L = 0.1\mu F, C_T = 1000 \text{ pF}$		24		
$t_R$	$V_{OUT}$ rise time	$R_L = 10 \Omega, C_L = 0.1\mu F, C_T = 1000 \text{ pF}$		400		
$t_F$	$V_{OUT}$ fall time	$R_L = 10 \Omega, C_L = 0.1\mu F, C_T = 1000 \text{ pF}$		5		
$t_D$	ON delay time	$R_L = 10 \Omega, C_L = 0.1\mu F, C_T = 1000 \text{ pF}$		395		
$V_{BIAS} = 3.3V, V_{ON} = 5V, V_{IN} = 3.3V, T_A = 25^\circ C$ (unless otherwise noted)						
$t_{ON}$	Turn on time	$R_L = 10 \Omega, C_L = 0.1\mu F, C_T = 1000 \text{ pF}$		1315		us
$t_{OFF}$	Turn off time	$R_L = 10 \Omega, C_L = 0.1\mu F, C_T = 1000 \text{ pF}$		28		
$t_R$	$V_{OUT}$ rise time	$R_L = 10 \Omega, C_L = 0.1\mu F, C_T = 1000 \text{ pF}$		1480		
$t_F$	$V_{OUT}$ fall time	$R_L = 10 \Omega, C_L = 0.1\mu F, C_T = 1000 \text{ pF}$		12		
$t_D$	ON delay time	$R_L = 10 \Omega, C_L = 0.1\mu F, C_T = 1000 \text{ pF}$		540		
$V_{BIAS} = 3.3V, V_{ON} = 5V, V_{IN} = 2.5V, T_A = 25^\circ C$ (unless otherwise noted)						
$t_{ON}$	Turn on time	$R_L = 10 \Omega, C_L = 0.1\mu F, C_T = 1000 \text{ pF}$		1115		us
$t_{OFF}$	Turn off time	$R_L = 10 \Omega, C_L = 0.1\mu F, C_T = 1000 \text{ pF}$		30		
$t_R$	$V_{OUT}$ rise time	$R_L = 10 \Omega, C_L = 0.1\mu F, C_T = 1000 \text{ pF}$		1160		
$t_F$	$V_{OUT}$ fall time	$R_L = 10 \Omega, C_L = 0.1\mu F, C_T = 1000 \text{ pF}$		10		
$t_D$	ON delay time	$R_L = 10 \Omega, C_L = 0.1\mu F, C_T = 1000 \text{ pF}$		515		
$V_{BIAS} = 3.3V, V_{ON} = 5V, V_{IN} = 1.8V, T_A = 25^\circ C$ (unless otherwise noted)						
$t_{ON}$	Turn on time	$R_L = 10 \Omega, C_L = 0.1\mu F, C_T = 1000 \text{ pF}$		920		us
$t_{OFF}$	Turn off time	$R_L = 10 \Omega, C_L = 0.1\mu F, C_T = 1000 \text{ pF}$		31		
$t_R$	$V_{OUT}$ rise time	$R_L = 10 \Omega, C_L = 0.1\mu F, C_T = 1000 \text{ pF}$		830		
$t_F$	$V_{OUT}$ fall time	$R_L = 10 \Omega, C_L = 0.1\mu F, C_T = 1000 \text{ pF}$		8		
$t_D$	ON delay time	$R_L = 10 \Omega, C_L = 0.1\mu F, C_T = 1000 \text{ pF}$		465		
$V_{BIAS} = 3.3V, V_{ON} = 5V, V_{IN} = 1.5V, T_A = 25^\circ C$ (unless otherwise noted)						
$t_{ON}$	Turn on time	$R_L = 10 \Omega, C_L = 0.1\mu F, C_T = 1000 \text{ pF}$		830		us
$t_{OFF}$	Turn off time	$R_L = 10 \Omega, C_L = 0.1\mu F, C_T = 1000 \text{ pF}$		33		
$t_R$	$V_{OUT}$ rise time	$R_L = 10 \Omega, C_L = 0.1\mu F, C_T = 1000 \text{ pF}$		695		
$t_F$	$V_{OUT}$ fall time	$R_L = 10 \Omega, C_L = 0.1\mu F, C_T = 1000 \text{ pF}$		7		
$t_D$	ON delay time	$R_L = 10 \Omega, C_L = 0.1\mu F, C_T = 1000 \text{ pF}$		440		
$V_{BIAS} = 3.3V, V_{ON} = 5V, V_{IN} = 1.2V, T_A = 25^\circ C$ (unless otherwise noted)						
$t_{ON}$	Turn on time	$R_L = 10 \Omega, C_L = 0.1\mu F, C_T = 1000 \text{ pF}$		760		us
$t_{OFF}$	Turn off time	$R_L = 10 \Omega, C_L = 0.1\mu F, C_T = 1000 \text{ pF}$		34		
$t_R$	$V_{OUT}$ rise time	$R_L = 10 \Omega, C_L = 0.1\mu F, C_T = 1000 \text{ pF}$		605		
$t_F$	$V_{OUT}$ fall time	$R_L = 10 \Omega, C_L = 0.1\mu F, C_T = 1000 \text{ pF}$		7		
$t_D$	ON delay time	$R_L = 10 \Omega, C_L = 0.1\mu F, C_T = 1000 \text{ pF}$		435		
$V_{BIAS} = 3.3V, V_{ON} = 5V, V_{IN} = 0.8V, T_A = 25^\circ C$ (unless otherwise noted)						
$t_{ON}$	Turn on time	$R_L = 10 \Omega, C_L = 0.1\mu F, C_T = 1000 \text{ pF}$		645		us
$t_{OFF}$	Turn off time	$R_L = 10 \Omega, C_L = 0.1\mu F, C_T = 1000 \text{ pF}$		36		
$t_R$	$V_{OUT}$ rise time	$R_L = 10 \Omega, C_L = 0.1\mu F, C_T = 1000 \text{ pF}$		420		
$t_F$	$V_{OUT}$ fall time	$R_L = 10 \Omega, C_L = 0.1\mu F, C_T = 1000 \text{ pF}$		5		

$t_D$	ON delay time	$R_L = 10 \Omega, C_L = 0.1 \mu F, C_T = 1000 \text{ pF}$		410		
$V_{BIAS} = 2.5V, V_{ON} = 5V, V_{IN} = 2.5V, T_A = 25^\circ C$ (unless otherwise noted)						
$t_{ON}$	Turn on time	$R_L = 10 \Omega, C_L = 0.1 \mu F, C_T = 1000 \text{ pF}$		1145		us
$t_{OFF}$	Turn off time	$R_L = 10 \Omega, C_L = 0.1 \mu F, C_T = 1000 \text{ pF}$		37		
$t_R$	$V_{OUT}$ rise time	$R_L = 10 \Omega, C_L = 0.1 \mu F, C_T = 1000 \text{ pF}$		1175		
$t_F$	$V_{OUT}$ fall time	$R_L = 10 \Omega, C_L = 0.1 \mu F, C_T = 1000 \text{ pF}$		15		
$t_D$	ON delay time	$R_L = 10 \Omega, C_L = 0.1 \mu F, C_T = 1000 \text{ pF}$		525		
$V_{BIAS} = 2.5V, V_{ON} = 5V, V_{IN} = 1.8V, T_A = 25^\circ C$ (unless otherwise noted)						
$t_{ON}$	Turn on time	$R_L = 10 \Omega, C_L = 0.1 \mu F, C_T = 1000 \text{ pF}$		935		us
$t_{OFF}$	Turn off time	$R_L = 10 \Omega, C_L = 0.1 \mu F, C_T = 1000 \text{ pF}$		41		
$t_R$	$V_{OUT}$ rise time	$R_L = 10 \Omega, C_L = 0.1 \mu F, C_T = 1000 \text{ pF}$		860		
$t_F$	$V_{OUT}$ fall time	$R_L = 10 \Omega, C_L = 0.1 \mu F, C_T = 1000 \text{ pF}$		12		
$t_D$	ON delay time	$R_L = 10 \Omega, C_L = 0.1 \mu F, C_T = 1000 \text{ pF}$		490		
$V_{BIAS} = 2.5V, V_{ON} = 5V, V_{IN} = 1.5V, T_A = 25^\circ C$ (unless otherwise noted)						
$t_{ON}$	Turn on time	$R_L = 10 \Omega, C_L = 0.1 \mu F, C_T = 1000 \text{ pF}$		850		us
$t_{OFF}$	Turn off time	$R_L = 10 \Omega, C_L = 0.1 \mu F, C_T = 1000 \text{ pF}$		43		
$t_R$	$V_{OUT}$ rise time	$R_L = 10 \Omega, C_L = 0.1 \mu F, C_T = 1000 \text{ pF}$		735		
$t_F$	$V_{OUT}$ fall time	$R_L = 10 \Omega, C_L = 0.1 \mu F, C_T = 1000 \text{ pF}$		10		
$t_D$	ON delay time	$R_L = 10 \Omega, C_L = 0.1 \mu F, C_T = 1000 \text{ pF}$		460		
$V_{BIAS} = 2.5V, V_{ON} = 5V, V_{IN} = 1.2V, T_A = 25^\circ C$ (unless otherwise noted)						
$t_{ON}$	Turn on time	$R_L = 10 \Omega, C_L = 0.1 \mu F, C_T = 1000 \text{ pF}$		780		us
$t_{OFF}$	Turn off time	$R_L = 10 \Omega, C_L = 0.1 \mu F, C_T = 1000 \text{ pF}$		45		
$t_R$	$V_{OUT}$ rise time	$R_L = 10 \Omega, C_L = 0.1 \mu F, C_T = 1000 \text{ pF}$		615		
$t_F$	$V_{OUT}$ fall time	$R_L = 10 \Omega, C_L = 0.1 \mu F, C_T = 1000 \text{ pF}$		9		
$t_D$	ON delay time	$R_L = 10 \Omega, C_L = 0.1 \mu F, C_T = 1000 \text{ pF}$		450		
$V_{BIAS} = 2.5V, V_{ON} = 5V, V_{IN} = 0.8V, T_A = 25^\circ C$ (unless otherwise noted)						
$t_{ON}$	Turn on time	$R_L = 10 \Omega, C_L = 0.1 \mu F, C_T = 1000 \text{ pF}$		660		us
$t_{OFF}$	Turn off time	$R_L = 10 \Omega, C_L = 0.1 \mu F, C_T = 1000 \text{ pF}$		48		
$t_R$	$V_{OUT}$ rise time	$R_L = 10 \Omega, C_L = 0.1 \mu F, C_T = 1000 \text{ pF}$		435		
$t_F$	$V_{OUT}$ fall time	$R_L = 10 \Omega, C_L = 0.1 \mu F, C_T = 1000 \text{ pF}$		7		
$t_D$	ON delay time	$R_L = 10 \Omega, C_L = 0.1 \mu F, C_T = 1000 \text{ pF}$		425		

### 9.7 PARAMETER MEASUREMENT INFORMATION

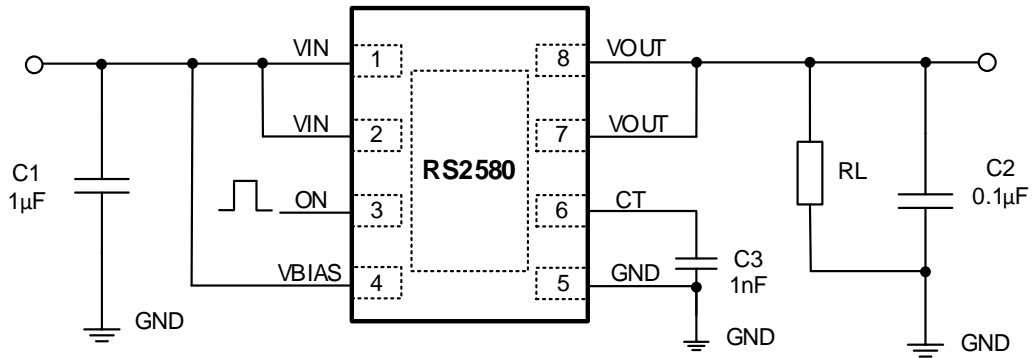

Figure 1. Test circuit

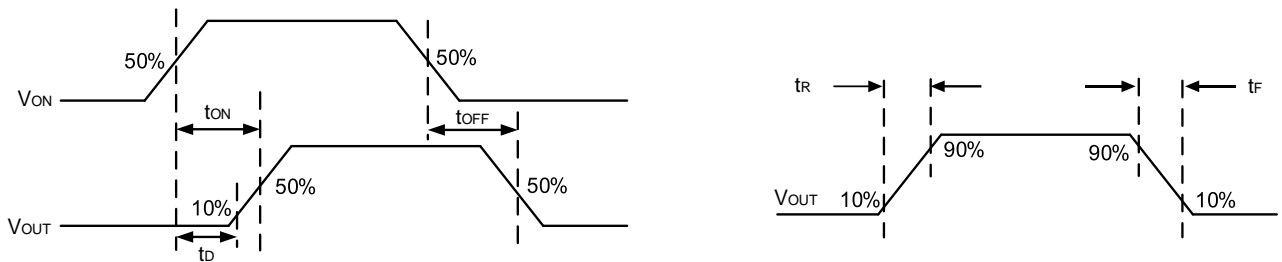

Figure 2. Switch Turn-On and Turn-Off Delay Times

### 9.8 Typical Performance Characteristics

T<sub>A</sub> = +25°C, unless otherwise noted.

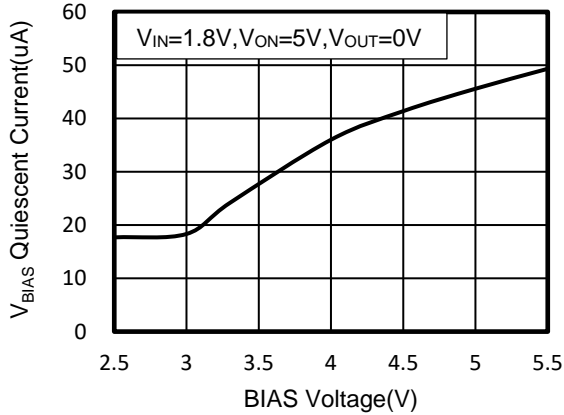

Figure 3. V<sub>BIAS</sub> Quiescent Current vs BIAS Voltage

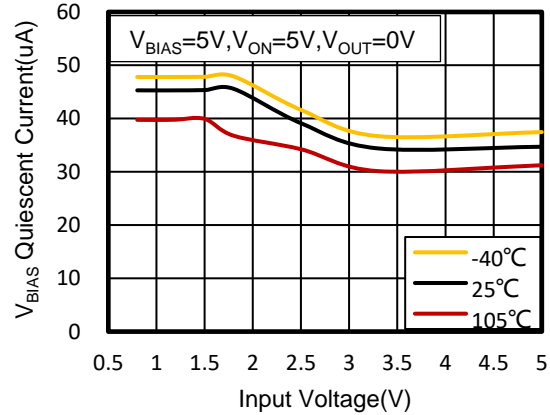

Figure 4. V<sub>BIAS</sub> Quiescent Current vs Input Voltage

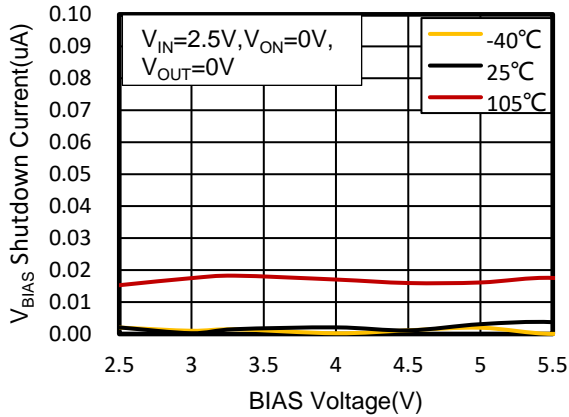

Figure 5. V<sub>BIAS</sub> Shutdown Current vs BIAS Voltage

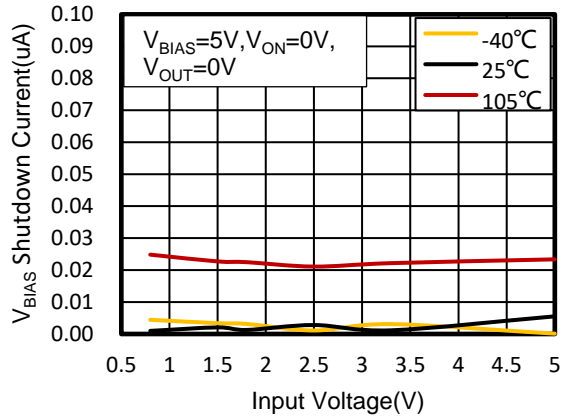

Figure 6. V<sub>BIAS</sub> Shutdown Current vs Input Voltage

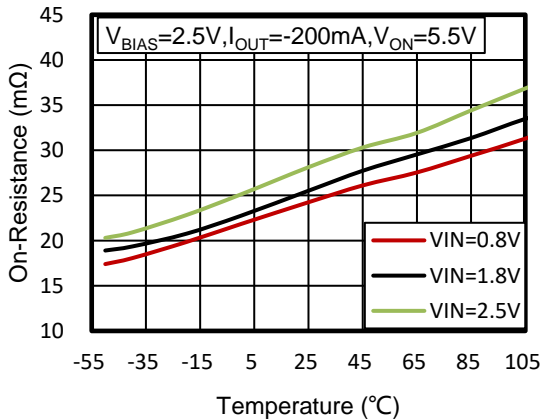

Figure 7. On Resistance vs Temperature

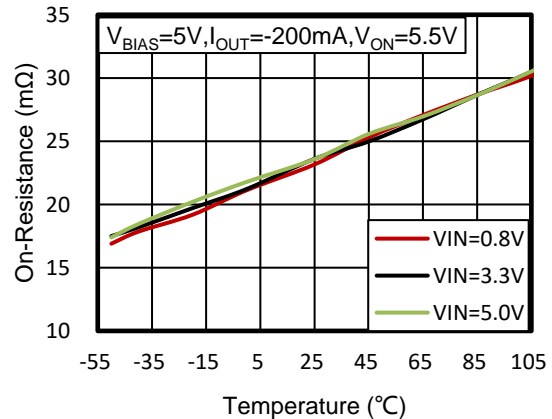

Figure 8. On Resistance vs Temperature

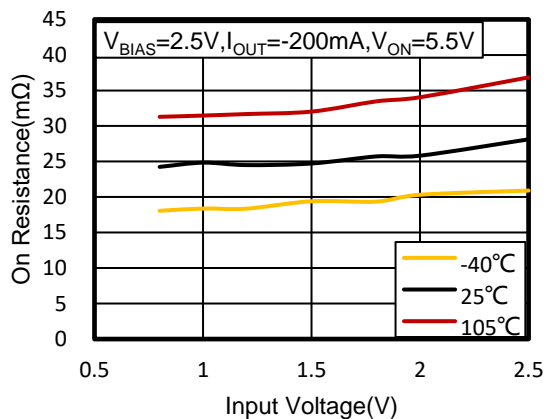

Figure 9. On Resistance vs Input Voltage

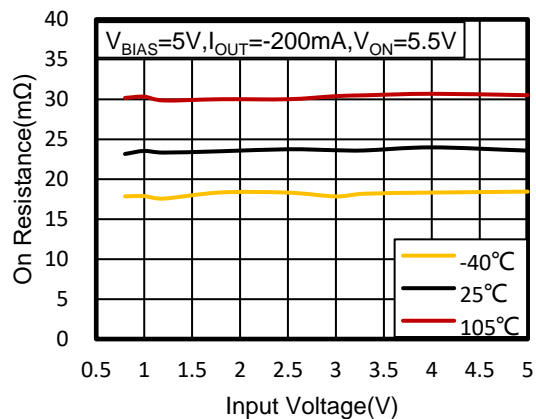

Figure 10. On Resistance vs Input Voltage

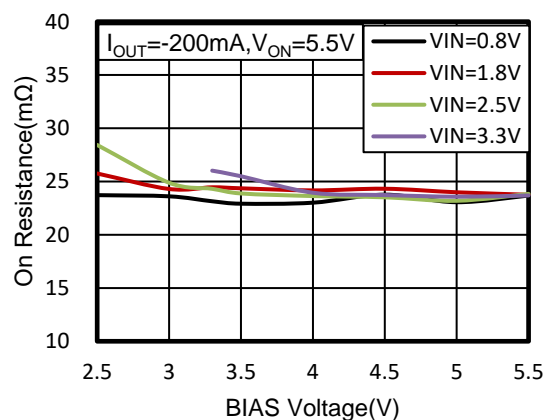

Figure 11. On Resistance vs BIAS Voltage

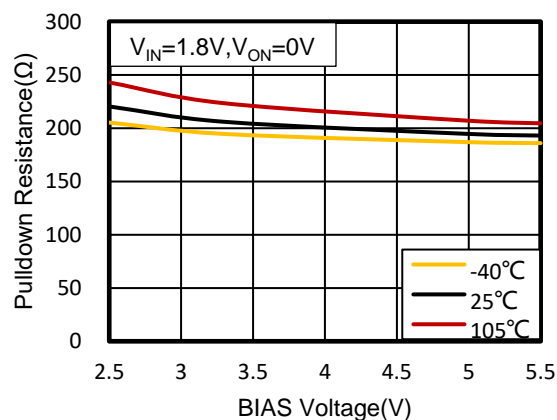

Figure 12. Pulldown Resistance vs BIAS Voltage

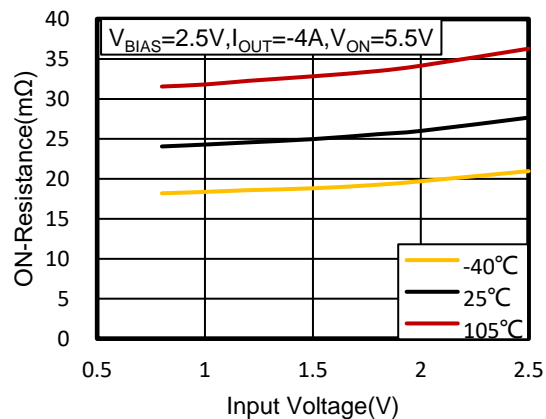

Figure 13. ON-Resistance vs Input Voltage

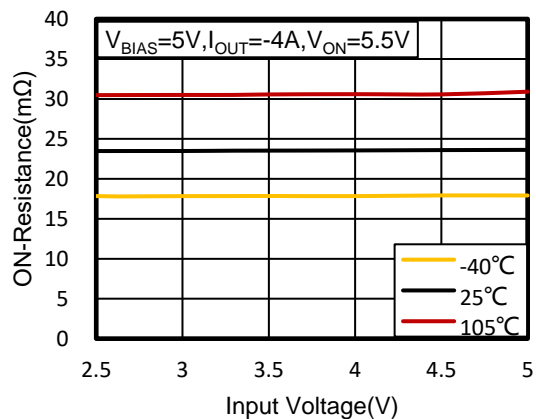

Figure 14. ON-Resistance vs Input Voltage

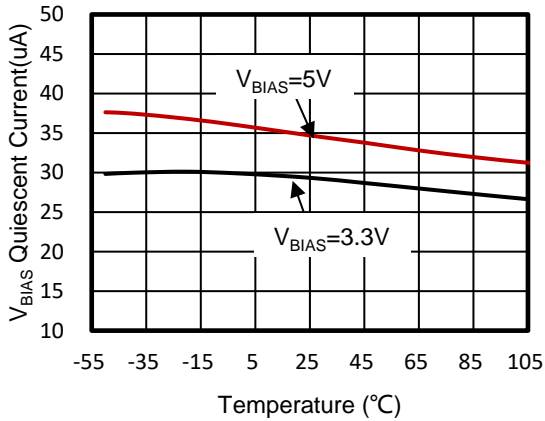

Figure 15.  $V_{BIAS}$  Quiescent Current vs Temperature

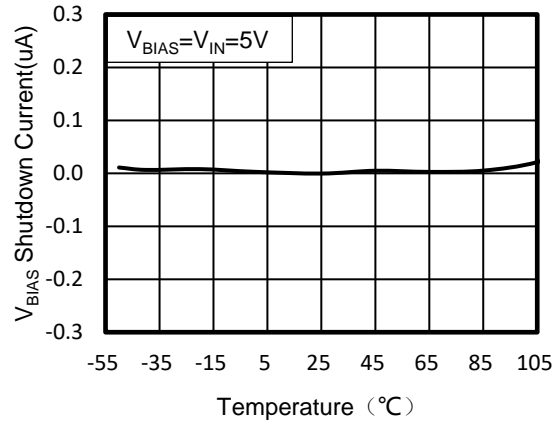

Figure 16.  $V_{BIAS}$  Shutdown Current vs Temperature

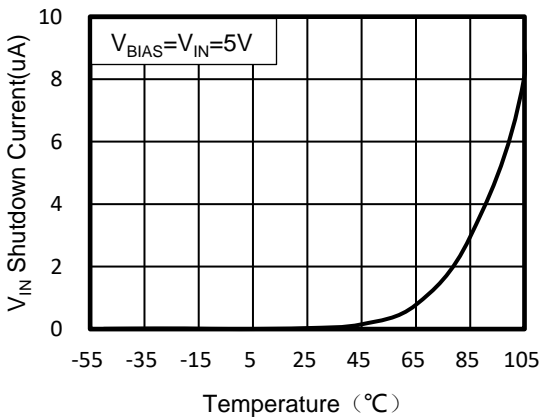

Figure 17.  $V_{IN}$  Shutdown Current vs Temperature

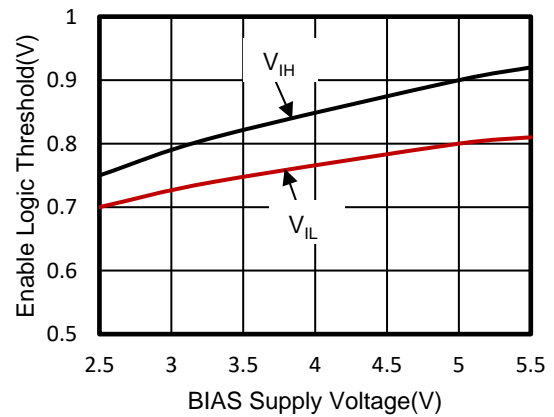

Figure 18. Enable Logic Threshold vs BIAS Supply Voltage

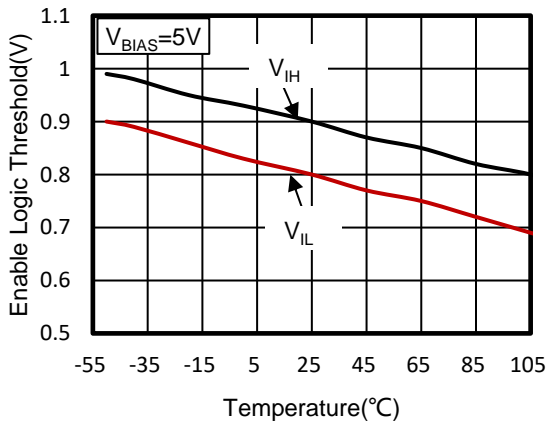

Figure 19. Enable Logic Threshold vs Temperature

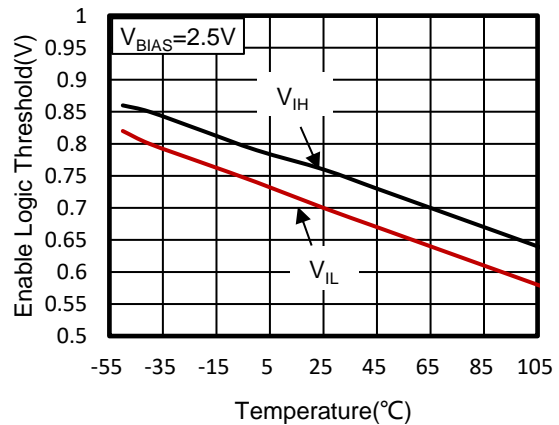

Figure 20. Enable Logic Threshold vs Temperature



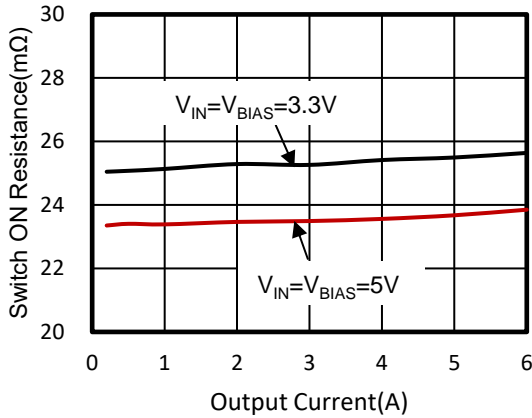

Figure 21. Switch ON Resistance vs Output Current

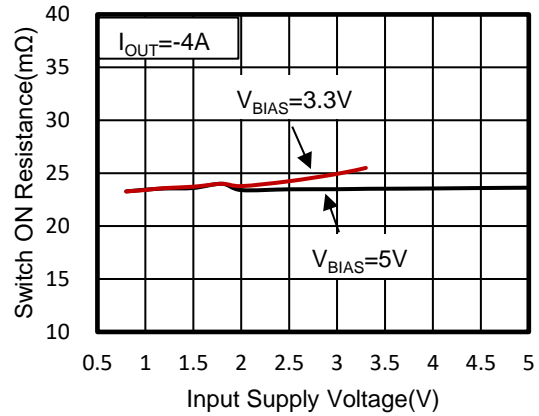

Figure 22. Switch ON Resistance vs Input Supply Voltage

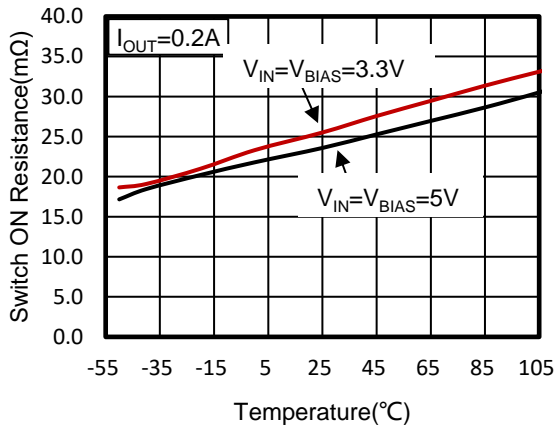

Figure 23. Switch ON Resistance vs Temperature

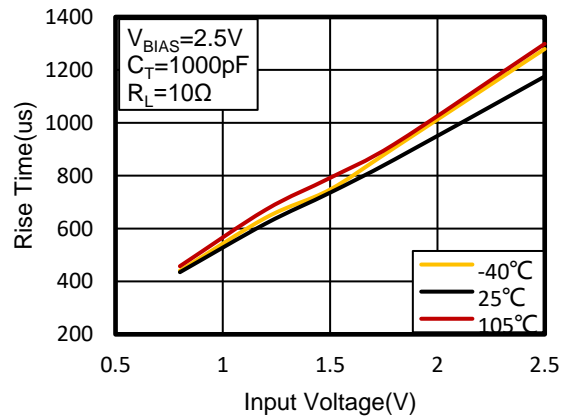

Figure 24. Rise Time vs Input Voltage

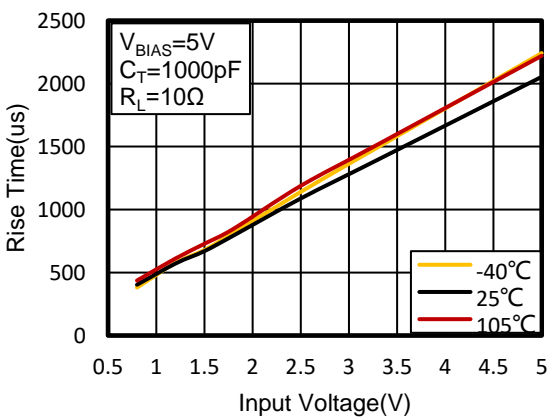

Figure 25. Rise Time vs Input Voltage

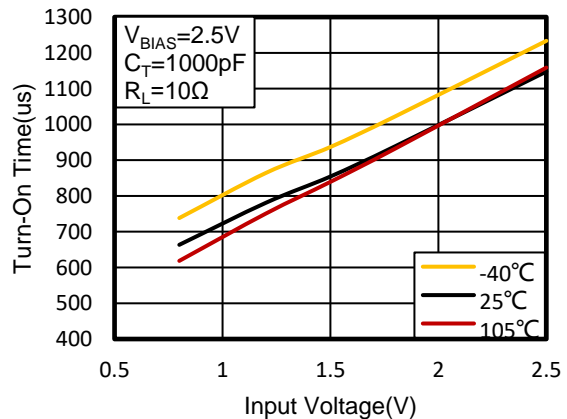

Figure 26. Turn-On Time vs Input Voltage

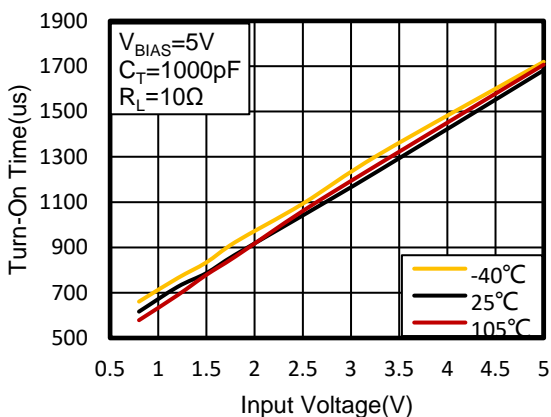

Figure 27. Turn-On Time vs Input Voltage

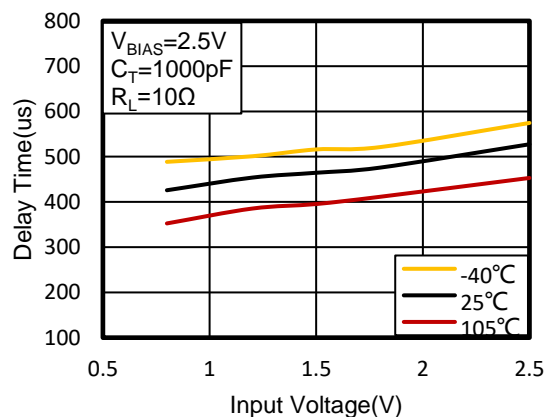

Figure 28. Delay Time vs Input Voltage

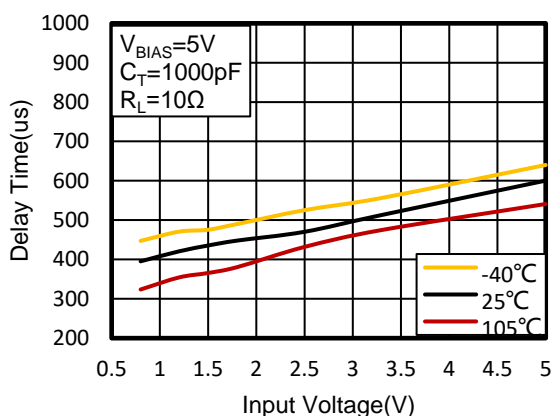

Figure 29. Delay Time vs Input Voltage

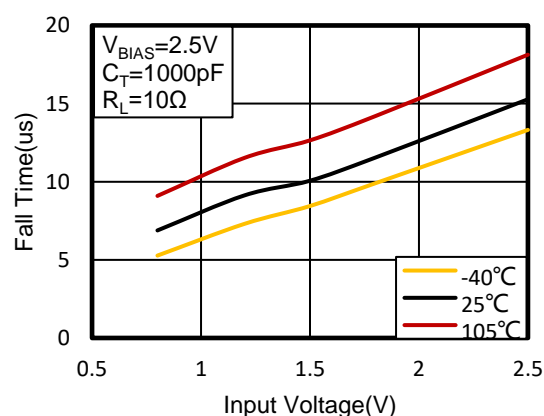

Figure 30. Fall Time vs Input Voltage

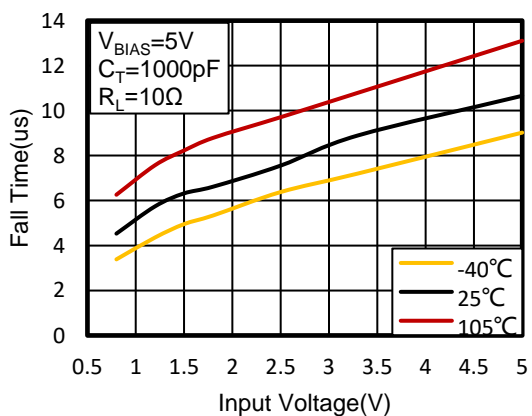

Figure 31. Fall Time vs Input Voltage

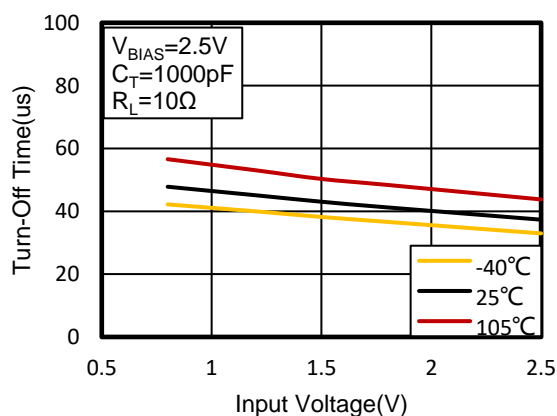

Figure 32. Turn-Off Time vs Input Voltage

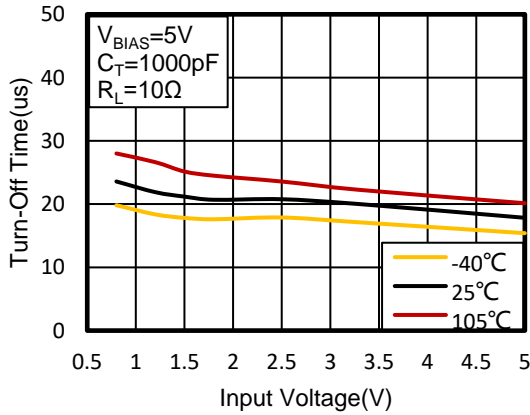

Figure 33. Turn-Off Time vs Input Voltage

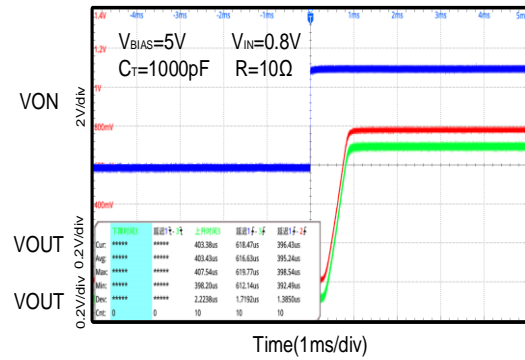

Figure 34. Turn-On Response Time

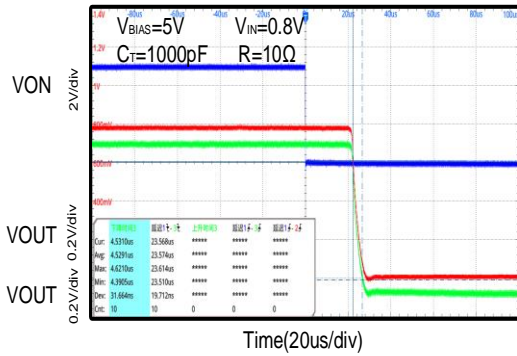

Figure 35. Turn-Off Response Time

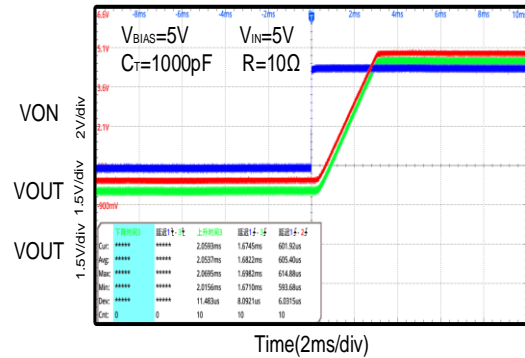

Figure 36. Turn-On Response Time

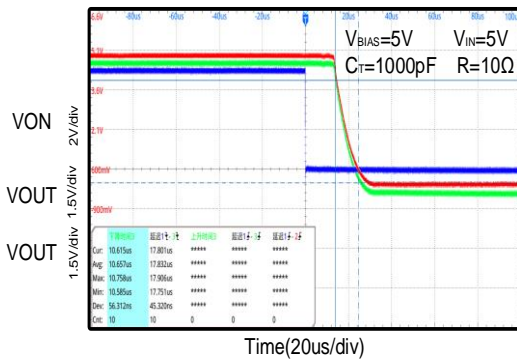

Figure 37. Turn-Off Response Time

## 10 FUNCTIONAL DESCRIPTION

### 10.1 Overview

The RS2580 is a single channel load switch that provides configurable rise time to minimize inrush current. The device contains an N-channel MOSFET that can operate over an input voltage range of 0.8V to 5.5V and can support a maximum continuous current of 6 A.

The switch is controlled by an on and off input (ON), which is capable of interfacing directly with low-voltage control signals. In the RS2580, a 220Ω on-chip load resistor is added for quick output discharge when switch is turned off.

The RS2580 is available in DFN2x2-8L package with integrated thermal pad allowing for high power dissipation. The device is characterized for operation over the free-air temperature range of -40°C to +105°C.

### 10.2 BIAS Under-voltage Lockout (UVLO)

An under-voltage lockout (UVLO) circuit monitors the BIAS pins voltage to prevent wrong logic controls. The UVLO function initiates a soft-start process after the BIAS supply voltages exceed rising UVLO voltage threshold during powering on.

### 10.3 Soft-Start

The RS2580 Provides an adjustable soft-start circuitry to control rise rate of the output voltage and limit the current surge during start-up. The soft-start time is set with a capacitor from the CT pin to the ground. (see 10.7 Adjustable Rise Time for more details)

### 10.4 Enable Control

The ON pin controls the state of the switch. Asserting ON high enables the switch. ON is active high and has a low threshold, making it capable of interfacing with low-voltage signals. The ON pin can be used with any microcontroller with 1.2 V or higher GPIO voltage. This pin **cannot be left floating** and must be driven either high or low for proper functionality.

### 10.5 Turn-On & Turn-off the device

The RS2580 turns on when  $V_{BIAS} > UVLO$  &  $ON = High$ . Make sure  $V_{BIAS}$  **cannot be left floating** and **must be powered on before VIN**. For optimal RON performance, **make sure  $V_{IN} \leq V_{BIAS}$** . Using  $ON = Low$  to turn off the device instead of using  $V_{BIAS} < UVLO$  to prevent the ultra-low but unpredictable leakage current which from VIN to OUT result in rising up the OUT voltage.

### 10.6 Supply filter capacitor

To limit the voltage, drop on the input supply caused by transient inrush currents when the switch turns on into a discharged load capacitor, a capacitor needs to be placed between VIN and GND. A 1-μF ceramic capacitor, CIN, placed close to the pins, is usually sufficient. Higher values of CIN can be used to further reduce the voltage drop during high current applications. When switching heavy loads, it is recommended to have an input capacitor about 10 times higher than the output capacitor to avoid excessive voltage drop.

Because of the integrated body diode in the NMOS switch, a CIN greater than CL is highly recommended. A CL greater than CIN can cause VOUT to exceed VIN when the system supply is removed. This could result in current flow through the body diode from VOUT to VIN. A CIN to CL ratio of 10 to 1 is recommended for minimizing VIN dip caused by inrush currents during startup; however, a 10 to 1 ratio for capacitance is not required for proper functionality of the device. A ratio smaller than 10 to 1 (such as 1 to 1) could cause slightly more VIN dip upon turn-on due to inrush currents. This can be mitigated by increasing the capacitance on the CT pin for a longer rise time (see 10.7 Adjustable Rise Time for more details).

### 10.7 Adjustable Rise Time

The soft-start capacitor on CT pin can reduce the inrush current and overshoot of output voltage. The soft-start time is set with a capacitor from the CT pin to the ground. The voltage on the CT pin can be as high as 12 V; therefore, the minimum voltage rating for the CT capacitor must be 25 V for optimal performance. The slew rate of VOUT is depended on CT capacitor, the relationship is shown in the equation as below:

$$SR = 0.38 \times CT + 34$$

SR is the slew rate (in us/V) from 10% to 90%

CT is the capacitance value on the CT pin (in pF)

The units for the constant 34 are us/V. The units for the constant 0.38 are us/(V×pF). An approximate formula for the relationship between CT and slew rate when VBIAS is set to 3.3V is shown in **Table 1** as well VBIAS is set to 5V is shown in **Table 2**.

**Table 1. Rise Time vs CT Capacitor**

CT (pF)	TYPICAL VALUES at 25°C with a 25 V X7R 10% CERAMIC CAPACITOR on CT <sup>(1)</sup>					
	V <sub>IN</sub> = 3.3V	V <sub>IN</sub> = 1.8V	V <sub>IN</sub> = 1.5V	V <sub>IN</sub> = 1.2V	V <sub>IN</sub> = 1.05V	V <sub>IN</sub> = 0.8V
0	226	139	118	107	96	79
220	500	292	246	216	195	154
470	832	460	400	347	310	245
1000	1484	834	697	605	540	424
2200	2935	1639	1385	1187	1046	820
4700	6234	3480	2910	2488	2214	1740
10000	14218	7869	6528	5578	4948	3813

(1) Rise time (µs) 10% - 90%, C<sub>L</sub> = 0.1 µF, C<sub>IN</sub> = 1 µF, R<sub>L</sub> = 10 Ω, V<sub>BIAS</sub> = 3.3V

**Table 2. Rise Time vs CT Capacitor**

CT (pF)	TYPICAL VALUES at 25°C with a 25 V X7R 10% CERAMIC CAPACITOR on CT <sup>(1)</sup>						
	V <sub>IN</sub> = 5V	V <sub>IN</sub> = 3.3V	V <sub>IN</sub> = 1.8V	V <sub>IN</sub> = 1.5V	V <sub>IN</sub> = 1.2V	V <sub>IN</sub> = 1.05V	V <sub>IN</sub> = 0.8V
0	299	212	130	116	100	91	75
220	683	467	275	237	204	185	147
470	1135	773	444	375	324	289	230
1000	2054	1396	793	645	572	506	403
2200	4134	2748	1547	1312	1124	987	777
4700	8714	5818	3264	2760	2356	2088	1627
10000	20246	13290	7436	6165	5295	4605	3620

(1) Rise time (µs) 10% - 90%, C<sub>L</sub> = 0.1 µF, C<sub>IN</sub> = 1 µF, R<sub>L</sub> = 10 Ω, V<sub>BIAS</sub> = 5 V

## 10.8 Inrush Current

When the switch is enabled, the output capacitors must be charged up from 0V to the set value. This charge arrives in the form of inrush current. Inrush current can be calculated as follow.

$$\text{Inrush current} = C \times dV/dt$$

Where

C is the output capacitance

dV is the output voltage

dt is the rise time depended on CT capacitance

## 10.9 Power dissipation

The device's junction temperature depends on several factors such as the load, PCB layout, ambient temperature, and package type. Equations that can be used to calculate power dissipation and junction temperature are found below:

$$P_D = R_{DS(ON)} \times I_{OUT}^2$$

To relate this to junction temperature, the following equation can be used:

$$T_J = P_D \times \theta_{JA} + T_A$$

Where:

T<sub>J</sub> = junction temperature

T<sub>A</sub> = ambient temperature

θ<sub>JA</sub> = the thermal resistance of the package

## 11 Layout

### 11.1 Layout Guidelines

For best performance, all traces must be as short as possible. To be most effective, the input and output capacitors must be placed close to the device to minimize the effects that parasitic trace inductances may have on normal operation. Using wide traces for VIN, VOUT, and GND helps minimize the parasitic electrical effects along with minimizing the case to ambient thermal impedance. The CT trace must be as short as possible to avoid parasitic capacitance.

### 11.2 Layout Example

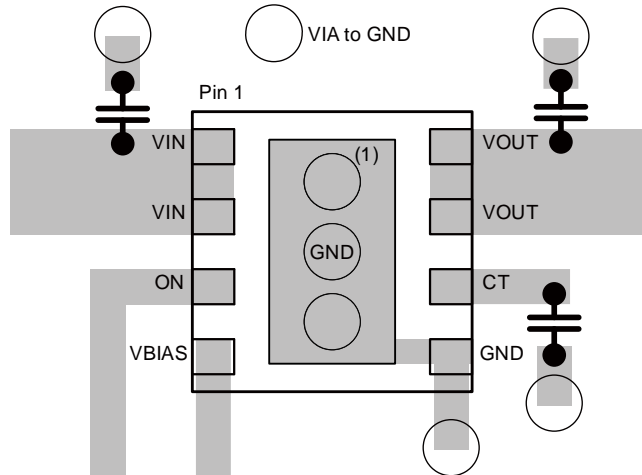
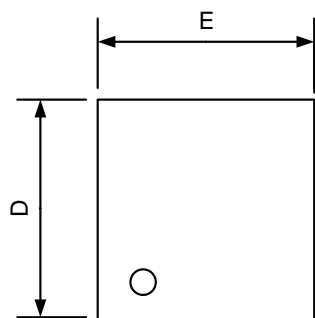
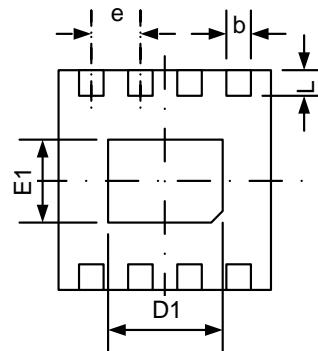
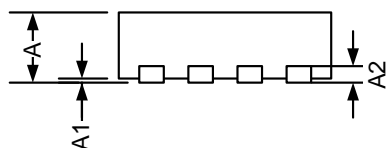
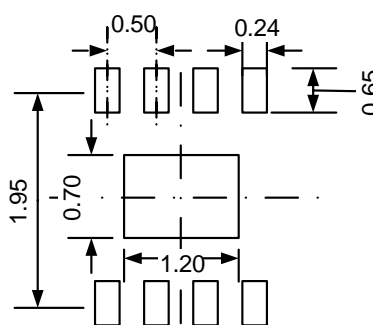

Figure 38. Layout Recommendation

# 12 PACKAGE OUTLINE DIMENSIONS

## DFN2x2-8L



**TOP VIEW**

**BOTTOM VIEW**

**SIDE VIEW**

**RECOMMENDED LAND PATTERN**  
(Unit: mm)

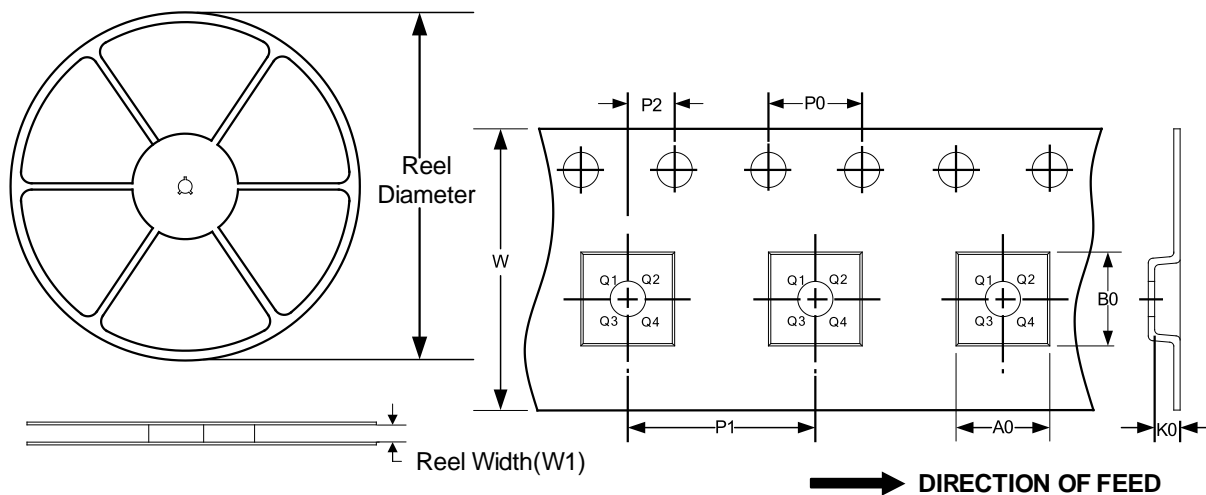
Symbol	Dimensions In Millimeters		Dimensions In Inches	
	Min	Max	Min	Max
A	0.700	0.800	0.028	0.031
A1	0.000	0.050	0.000	0.002
A2	0.203(TYP)		0.008(TYP)	
b	0.180	0.300	0.007	0.012
D	1.900	2.100	0.075	0.083
D1	1.100	1.300	0.043	0.051
E	1.900	2.100	0.075	0.083
E1	0.600	0.800	0.024	0.031
e	0.500(TYP)		0.020(TYP)	
L	0.250	0.450	0.010	0.018

### 13 TAPE AND REEL INFORMATION

#### REEL DIMENSIONS

#### TAPE DIMENSION



NOTE: The picture is only for reference. Please make the object as the standard.

#### KEY PARAMETER LIST OF TAPE AND REEL

Package Type	Reel Diameter	Reel Width (mm)	A0 (mm)	B0 (mm)	K0 (mm)	P0 (mm)	P1 (mm)	P2 (mm)	W (mm)	Pin1 Quadrant
DFN2x2-8L	7"	9.5	2.30	2.30	1.10	4.0	4.0	2.0	8.0	Q2