

RS1G06 Single Inverter Buffer/Driver with Open-Drain Output

1 FEATURES

- Operating Voltage Range: 1.65V to 5.5V
- Low Power Consumption: 1µA (Max)
- Operating Temperature Range: -40°C to +125°C
- Input and Open-Drain Output accept Voltage to 5.5V
- High Output Drive: ±24mA at V_{CC}=3.0V
- Micro SIZE PACKAGES: SOT23-5, SOT353(SC70-5)

2 APPLICATIONS

- Blu-ray Players and Home Theaters
- Desktops or Notebook PCs
- Digital Video Cameras (DVC)
- Mobile Phones
- Personal Navigation Device (GPS)
- Portable Media Player

Functional Block Diagram

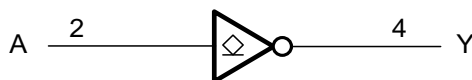

3 DESCRIPTION

The RS1G06 Single inverter buffer and driver is designed for 1.65V to 5.5V V_{CC} operation.

The RS1G06 device is open drain and can be connected to other open-drain outputs to implement active-low wired-OR or active-high wired-AND functions. The device is fully specified for partial-power-down applications using I_{off}. The I_{off} circuitry disables the outputs, preventing damaging current backflow through the device when it is powered down.

The RS1G06 is available in Green SOT23-5 and SOT353(SC70-5) packages. It operates over an ambient temperature range of -40°C to +125°C.

Device Information (1)

PART NUMBER	PACKAGE	BODY SIZE (NOM)
RS1G06	SOT23-5(5)	2.92mm×1.60mm
	SOT353 (SC70-5)(5)	2.10mm×1.25mm

(1) For all available packages, see the orderable addendum at the end of the data sheet.

4 FUNCTION TABLE

INPUT	OUTPUT
A	Y
H	L
L	Z

H=High Voltage Level
L=Low Voltage Level
Z=High-impedance OFF-state

Table of Contents

1 FEATURES	1
2 APPLICATIONS	1
3 DESCRIPTION	1
4 FUNCTION TABLE	1
5 Revision History	3
6 PACKAGE/ORDERING INFORMATION	4
7 PIN CONFIGURATIONS	5
8 SPECIFICATIONS	6
8.1 Absolute Maximum Ratings ⁽¹⁾	6
8.2 ESD Ratings.....	6
8.3 Thermal Information:.....	6
8.4 Recommended Operating Conditions.....	7
8.5 ELECTRICAL CHARACTERISTICS.....	8
9 Parameter Measurement Information	9
10 PACKAGE OUTLINE DIMENSIONS	10
11 TAPE AND REEL INFORMATION	12

5 Revision History

Note: Page numbers for previous revisions may differ from page numbers in the current version.

Version	Change Date	Change Item
A.1	2022/04/28	Initial version completed

6 PACKAGE/ORDERING INFORMATION

PRODUCT	ORDERING NUMBER	TEMPERATURE RANGE	PACKAGE LEAD	PACKAGE MARKING ⁽¹⁾	PACKAGE OPTION
RS1G06	RS1G06XC5	-40°C ~+125°C	SC70-5(SOT353)	1G06	Tape and Reel,3000
	RS1G06XF5	-40°C ~+125°C	SOT23-5	1G06	Tape and Reel,3000

NOTE:

- (1) There may be additional marking, which relates to the lot trace code information (data code and vendor code), the logo or the environmental category on the device.

7 PIN CONFIGURATIONS

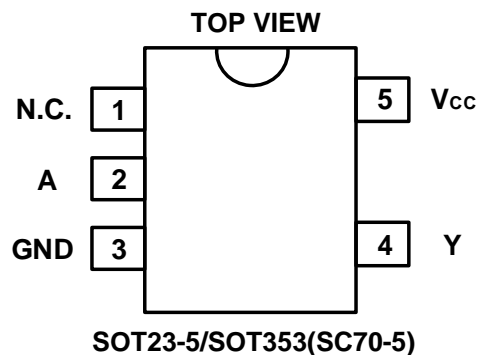

PIN DESCRIPTION

PIN	NAME	I/O TYPE	FUNCTION
SOT23-5/SOT353(SC70-5)			
1	N.C.	-	Not connected
2	A	I	Input
3	GND	P	Ground
4	Y	O	Output
5	V _{cc}	P	Power Pin

8 SPECIFICATIONS

8.1 Absolute Maximum Ratings ⁽¹⁾

over operating free-air temperature range (unless otherwise noted) ⁽¹⁾ ⁽²⁾

		MIN	MAX	UNIT
V _{CC}	Supply voltage range	-0.5	6.5	V
V _I	Input voltage range ⁽²⁾	-0.5	6.5	V
V _O	Voltage range applied to any output in the high-impedance or power-off state ⁽²⁾	-0.5	6.5	V
V _O	Voltage range applied to any output in the high or low state ⁽²⁾ ⁽³⁾	-0.5	6.5	V
I _{IK}	Input clamp current	V _I <0	-50	mA
I _{OK}	Output clamp current	V _O <0	-50	mA
I _O	Continuous output current		±50	mA
	Continuous current through V _{CC} or GND		±100	mA
T _J	Junction temperature	-65	150	°C
T _{stg}	Storage temperature	-65	150	°C

(1) Stresses beyond those listed under *Absolute Maximum Ratings* may cause permanent damage to the device. These are stress ratings only, and functional operation of the device at these or any other conditions beyond those indicated under *Recommended Operating Conditions* is not implied. Exposure to absolute-maximum-rated conditions for extended periods may affect device reliability.

(2) The input and output negative-voltage ratings may be exceeded if the input and output current ratings are observed.

(3) The value of V_{CC} is provided in the *Recommended Operating Conditions table*.

8.2 ESD Ratings

		VALUE	UNIT
V _(ESD)	Electrostatic discharge		
	Human-body model (HBM)	±6000	V
	Charged device model (CDM)	±1500	V
	Machine model (MM)	±200	V

8.3 Thermal Information:

THERMAL METRIC		RS1G06		UNIT
		5PINS		
		SOT23-5	SOT353/(SC70-5)	
R _{θJA}	Junction-to-ambient thermal resistance	273.8	214.7	°C/W
R _{θJC(top)}	Junction-to-case(top) thermal resistance	126.8	127.1	°C/W
R _{θJB}	Junction-to-board thermal resistance	85.9	60.0	°C/W
Ψ _{JT}	Junction-to-top characterization parameter	10.9	33.4	°C/W
Ψ _{JB}	Junction-to-board characterization parameter	84.9	59.8	°C/W
R _{θJC(bot)}	Junction-to-case(bottom) thermal resistance	N/A	N/A	°C/W

8.4 Recommended Operating Conditions

PARAMETER	SYMBOL	TEST CONDITIONS	MIN	MAX	UNIT
Supply voltage	V _{CC}	Operating	1.65	5.5	V
		Data retention only	1.5		
High-level input voltage	V _{IH}	V _{CC} =1.65V to 1.95V	0.65xV _{CC}		V
		V _{CC} =2.3V to 2.7V	1.7		
		V _{CC} =3V to 3.6V	2.2		
		V _{CC} =4.5V to 5.5V	0.7xV _{CC}		
Low-level input voltage	V _{IL}	V _{CC} =1.65V to 1.95V		0.15xV _{CC}	V
		V _{CC} =2.3V to 2.7V		0.3	
		V _{CC} =3V to 3.6V		0.4	
		V _{CC} =4.5V to 5.5V		0.15xV _{CC}	
Input voltage	V _I		0	5.5	V
Output voltage	V _O		0	5.5	V
Input transition rise or fall	Δt/Δv	V _{CC} =1.8V± 0.15V, 2.5V ± 0.2V		20	ns/V
		V _{CC} =3.3V± 0.3V		10	
		V _{CC} =5V± 0.5V		5	
Operating temperature	T _A		-40	+125	°C

(1) All unused inputs of the device must be held at V_{CC} or GND to ensure proper device operation.

8.5 ELECTRICAL CHARACTERISTICS

over recommended operating free-air temperature range (Full=-40°C to +125°C, typical values are at T_A = +25°C, unless otherwise noted.) ⁽¹⁾

DC Characteristics

PARAMETER		TEST CONDITIONS	V _{CC}	TEMP	MIN	TYP	MAX	UNIT
V _{OL}		I _{OL} = 100μA	1.65V to 5.5V	Full			0.1	V
		I _{OL} = 4mA	1.65V				0.45	
		I _{OL} = 8mA	2.3V				0.3	
		I _{OL} = 16mA	3V				0.4	
		I _{OL} = 24mA					0.55	
		I _{OL} = 32mA	4.5V				0.55	
I _I	A input	V _I =5.5V or GND	0V to 5.5V	+25°C		±0.1	±1	μA
				Full			±5	
I _{off}		V _I or V _O =5.5V	0	+25°C		±0.1	±1	μA
				Full			±10	
I _{CC}		V _I =5.5V or GND, I _O =0	1.65V to 5.5V	+25°C		0.1	1	μA
				Full			10	
ΔI _{CC}		One input at V _{CC} -0.6V, Other inputs at V _{CC} or GND	3V to 5.5V	Full			500	μA

AC Characteristics

PARAMETER	SYMBOL	TEST CONDITIONS		TEMP	MIN	TYP	MAX	UNIT
Propagation Delay	t _{pd}	V _{CC} =1.8V±0.15V	C _L =30pF, R _L =1kΩ	Full		6.4		ns
		V _{CC} =2.5V±0.2V	C _L =30pF, R _L =500Ω	Full		4.5		
		V _{CC} =3.3V±0.3V	C _L =50pF, R _L =500Ω	Full		4.2		
		V _{CC} =5V±0.5V	C _L =50pF, R _L =500Ω	Full		3.7		
Input Capacitance	C _i	V _{CC} =3.3V	V _I =V _{CC} or GND	+25°C		4		pF
Power dissipation capacitance	C _{pd}	V _{CC} =1.8V	f=10MHz	+25°C		3		pF
		V _{CC} =2.5V				3		
		V _{CC} =3.3V				4		
		V _{CC} =5V				6		

(1) All unused inputs of the device must be held at V_{CC} or GND to ensure proper device operation.

9 Parameter Measurement Information

Open-Drain

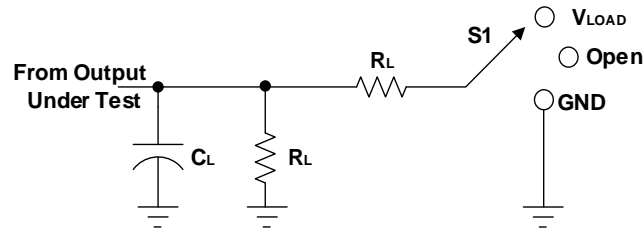

TEST	S1
t_{PLH}/t_{PHL}	Open
t_{PLZ}/t_{PZL}	V_{LOAD}
t_{PHZ}/t_{PZH}	GND

V_{CC}	INPUTS		V_M	V_{LOAD}	CL		RL		V_{Δ}
	V_I	t_r/t_f							
$1.8V \pm 0.15V$	V_{CC}	$\leq 2ns$	$V_{CC}/2$	$2 \times V_{CC}$	15pF	30pF	1M Ω	1k Ω	0.15V
$2.5V \pm 0.2V$	V_{CC}	$\leq 2ns$	$V_{CC}/2$	$2 \times V_{CC}$	15pF	30pF	1M Ω	500 Ω	0.15V
$3.3V \pm 0.3V$	3V	$\leq 2.5ns$	1.5V	6V	15pF	50pF	1M Ω	500 Ω	0.3V
$5V \pm 0.5V$	V_{CC}	$\leq 2.5ns$	$V_{CC}/2$	$2 \times V_{CC}$	15pF	50pF	1M Ω	500 Ω	0.3V

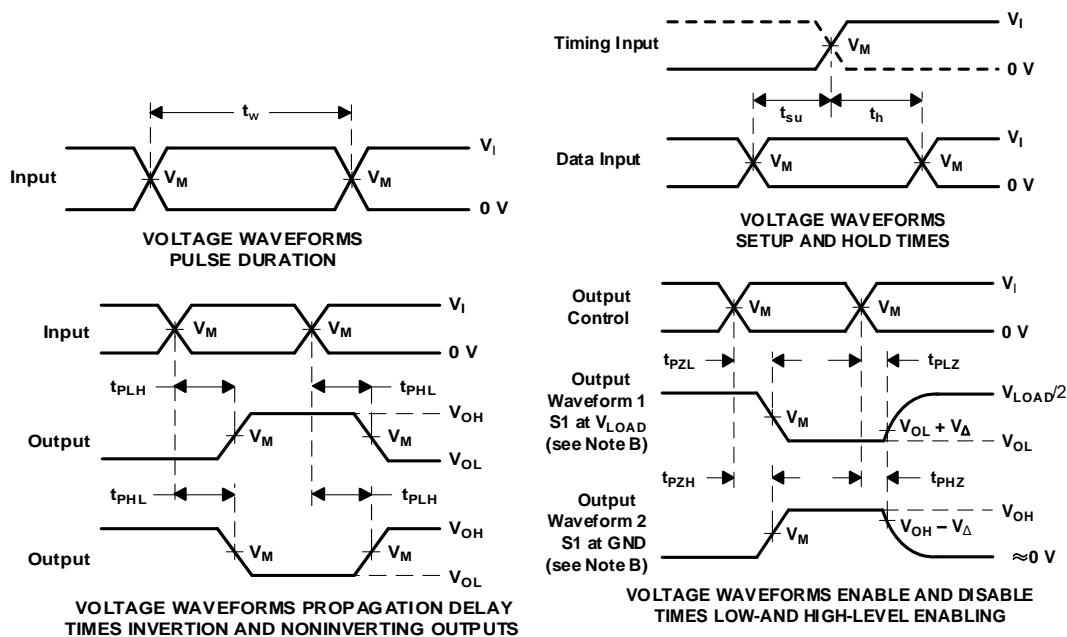

- NOTES:
- A. CL includes probe and jig capacitance.
 - B. Waveform 1 is for an output with internal conditions such that the output is low, except when disabled by the output control. Waveform 2 is for an output with internal conditions such that the output is high, except when disabled by the output control.
 - C. All input pulses are supplied by generators having the following characteristics: $PRR \leq 10 \text{ MHz}$, $Z_O = 50 \Omega$.
 - D. The outputs are measured one at a time, with one transition per measurement.
 - E. t_{PLZ} and t_{PHZ} are the same as t_{dis} .
 - F. t_{PZL} and t_{PZH} are the same as t_{en} .
 - G. t_{PLH} and t_{PHL} are the same as t_{pd} .
 - H. All parameters and waveforms are not applicable to all devices.

Figure 1. Load Circuit and Voltage Waveforms

10 PACKAGE OUTLINE DIMENSIONS

SOT23-5

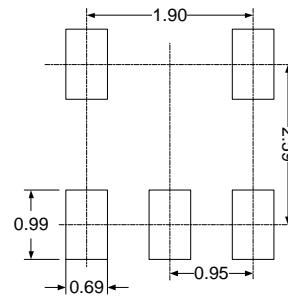
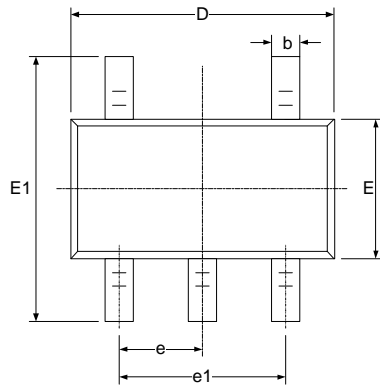
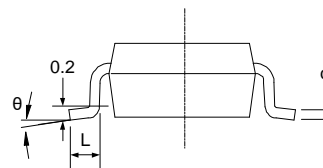
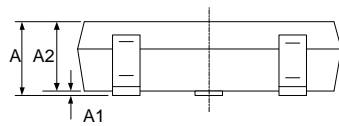
RECOMMENDED LAND PATTERN (Unit: mm)

Symbol	Dimensions In Millimeters		Dimensions In Inches	
	Min	Max	Min	Max
A	1.050	1.250	0.041	0.049
A1	0.000	0.100	0.000	0.004
A2	1.050	1.150	0.041	0.045
b	0.300	0.500	0.012	0.020
c	0.100	0.200	0.004	0.008
D	2.820	3.020	0.111	0.119
E	1.500	1.700	0.059	0.067
E1	2.650	2.950	0.104	0.116
e	0.950(BSC)		0.037(BSC)	
e1	1.800	2.000	0.071	0.079
L	0.300	0.600	0.012	0.024
θ	0°	8°	0°	8°

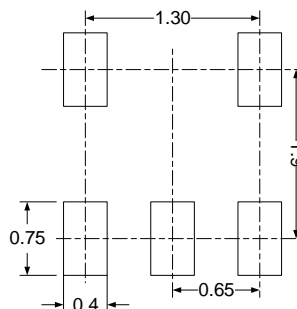
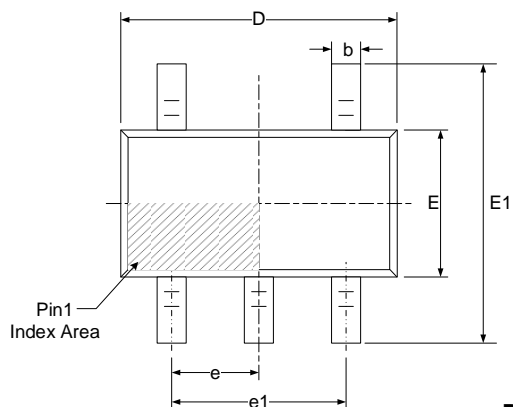
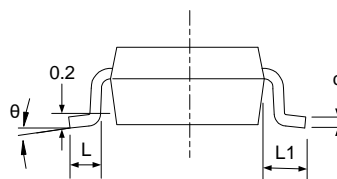
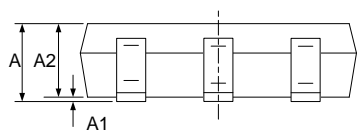
SOT353 (SC70-5)

RECOMMENDED LAND PATTERN (Unit: mm)

Symbol	Dimensions In Millimeters		Dimensions In Inches	
	Min	Max	Min	Max
A	0.900	1.100	0.035	0.043
A1	0.000	0.100	0.000	0.004
A2	0.900	1.000	0.035	0.039
b	0.150	0.350	0.006	0.014
c	0.080	0.150	0.003	0.006
D	2.000	2.200	0.079	0.087
E	1.150	1.350	0.045	0.053
E1	2.150	2.450	0.085	0.096
e	0.650(BSC)		0.026(BSC)	
e1	1.300(BSC)		0.051(BSC)	
L	0.260	0.460	0.010	0.018
L1	0.525		0.021	
θ	0°	8°	0°	8°

11 TAPE AND REEL INFORMATION

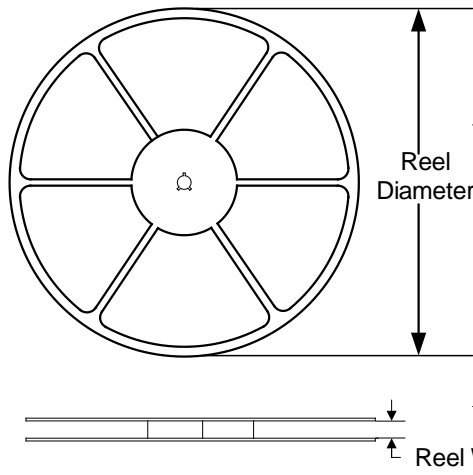
REEL DIMENSIONS



TAPE DIMENSION

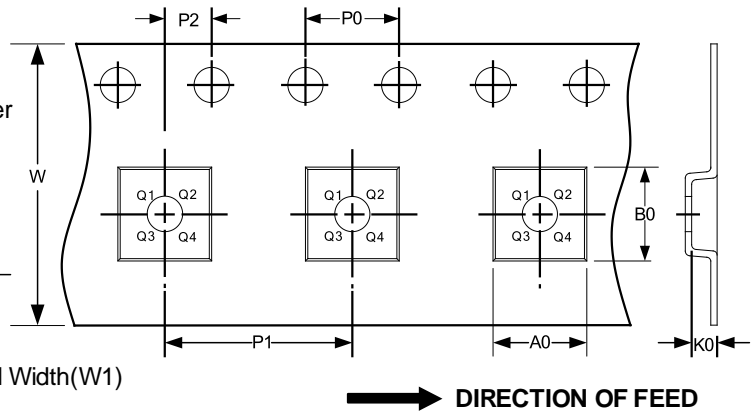

NOTE: The picture is only for reference. Please make the object as the standard.

KEY PARAMETER LIST OF TAPE AND REEL

Package Type	Reel Diameter	Reel Width(mm)	A0 (mm)	B0 (mm)	K0 (mm)	P0 (mm)	P1 (mm)	P2 (mm)	W (mm)	Pin1 Quadrant
SOT353(SC70-5)	7"	9.5	2.25	2.55	1.20	4.0	4.0	2.0	8.0	Q3
SOT23-5	7"	9.5	3.20	3.20	1.40	4.0	4.0	2.0	8.0	Q3