

# RS1G00 Single 2-Input Positive-NAND Gate

## FEATURES

- Operating Voltage Range: 1.65V to 5.5V
- Low Power Consumption: 1µA (Max)
- Operating Temperature Range: -40°C to +125°C
- Inputs Accept Voltage to 5.5V
- High Output Drive: ±24mA at V<sub>CC</sub>=3.0V
- Micro SIZE PACKAGES: SOT23-5, SC70-5

## APPLICATIONS

- Active Noise Elimination
- Bar Code Scanner
- Blood Pressure Monitor
- CPAP Machine
- Fingerprint identification
- Network attached storage (NAS)

### LOGIC SYMBOL

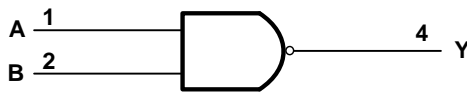

## DESCRIPTION

The RS1G00 single 2-input positive-NAND gate is designed for 1.65V to 5.5V V<sub>CC</sub> operation.

The RS1G00 device performs the Boolean function  $Y = \overline{A \cdot B}$  or  $Y = \overline{A} + \overline{B}$  in positive logic. The device is fully specified for partial-power-down applications using I<sub>off</sub>. The I<sub>off</sub> circuitry disables the outputs, preventing damaging current backflow through the device when it is powered down.

The RS1G00 is available in Green SOT23-5 and SC70-5 packages. It operates over an ambient temperature range of -40°C to +125°C.

### Device Information (1)

PART NUMBER	PACKAGE	BODY SIZE (NOM)
RS1G00	SOT23-5(5)	2.92mm×1.60mm
	SC70-5(5)	2.10mm×1.25mm

(1) For all available packages, see the orderable addendum at the end of the data sheet.

### FUNCTION TABLE

INPUTS		OUTPUT
A	B	Y
H	H	L
L	H	H
H	L	H
L	L	H

H=High Voltage Level

L=Low Voltage Level

## Revision History

Note: Page numbers for previous revisions may differ from page numbers in the current version.

Version	Change Date	Change Item
A.1	2021/01/25	Initial version completed
A.2	2022/04/27	1. Added the TAPE AND REEL INFORMATION 2. Update PACKAGE MARKING on Page 5@RevA.1

## PIN CONFIGURATIONS

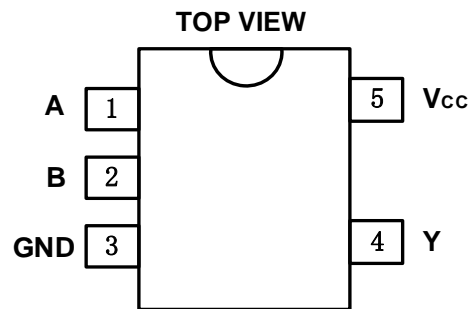

**SOT23-5/SOT353(SC70-5)**

## PIN DESCRIPTION

PIN	NAME	I/O TYPE	FUNCTION
<b>SOT23-5/SOT353(SC70-5)</b>			
1	A	I	Input
2	B	I	Input
3	GND	P	Ground
4	Y	O	Output
5	V <sub>cc</sub>	P	Power pin

## Specifications

### Absolute Maximum Ratings <sup>(1)</sup>

over operating free-air temperature range (unless otherwise noted) <sup>(1)</sup> <sup>(2)</sup>

		MIN	MAX	UNIT
V <sub>CC</sub>	Supply voltage range	-0.5	6.5	V
V <sub>I</sub>	Input voltage range <sup>(2)</sup>	-0.5	6.5	V
V <sub>O</sub>	Voltage range applied to any output in the high-impedance or power-off state <sup>(2)</sup>	-0.5	6.5	V
V <sub>O</sub>	Voltage range applied to any output in the high or low state <sup>(2)</sup> <sup>(3)</sup>	-0.5	V <sub>CC</sub> +0.5	V
I <sub>IK</sub>	Input clamp current	V <sub>I</sub> <0	-50	mA
I <sub>OK</sub>	Output clamp current	V <sub>O</sub> <0	-50	mA
I <sub>O</sub>	Continuous output current		±50	mA
	Continuous current through V <sub>CC</sub> or GND		±100	mA
T <sub>J</sub>	Junction temperature	-65	150	°C
T <sub>stg</sub>	Storage temperature	-65	150	°C

- (1) Stresses beyond those listed under *Absolute Maximum Ratings* may cause permanent damage to the device. These are stress ratings only, and functional operation of the device at these or any other conditions beyond those indicated under *Recommended Operating Conditions* is not implied. Exposure to absolute-maximum-rated conditions for extended periods may affect device reliability.
- (2) The input and output negative-voltage ratings may be exceeded if the input and output current ratings are observed.
- (3) The value of V<sub>CC</sub> is provided in the *Recommended Operating Conditions table*.

### ESD Ratings

		VALUE	UNIT	
V <sub>(ESD)</sub>	Electrostatic discharge	Human-body model (HBM)	±8000	V
		Machine model (MM)	±500	V

### Thermal Information:

THERMAL METRIC		RS1G00		UNIT
		5PINS		
		SOT23-5	SOT353/(SC70-5)	
R <sub>θJA</sub>	Junction-to-ambient thermal resistance	273.8	214.7	°C/W
R <sub>θJC(top)</sub>	Junction-to-case(top) thermal resistance	126.8	127.1	°C/W
R <sub>θJB</sub>	Junction-to-board thermal resistance	85.9	60.0	°C/W
Ψ <sub>JT</sub>	Junction-to-top characterization parameter	10.9	33.4	°C/W
Ψ <sub>JB</sub>	Junction-to-board characterization parameter	84.9	59.8	°C/W
R <sub>θJC(bot)</sub>	Junction-to-case(bottom) thermal resistance	N/A	N/A	°C/W

**PACKAGE/ORDERING INFORMATION**

PRODUCT	ORDERING NUMBER	TEMPERATURE RANGE	PACKAGE LEAD	PACKAGE MARKING <sup>(1)</sup>	PACKAGE OPTION
RS1G00	RS1G00XF5	-40°C ~+125°C	SOT23-5	1G00	Tape and Reel,3000
	RS1G00XC5	-40°C ~+125°C	SC70-5(SOT353)	1G00	Tape and Reel,3000

## NOTE:

- (1) There may be additional marking, which relates to the lot trace code information (data code and vendor code), the logo or the environmental category on the device.

## ELECTRICAL CHARACTERISTICS

over recommended operating free-air temperature range (TYP values are at  $T_A = +25^{\circ}\text{C}$ , unless otherwise noted.) <sup>(1)</sup>

### Recommended Operating Conditions <sup>(1)</sup>

PARAMETER	SYMBOL	TEST CONDITIONS	MIN	MAX	UNIT
Supply voltage	$V_{CC}$	Operating	1.65	5.5	V
		Data retention only	1.5	5.5	
High-level input voltage	$V_{IH}$	$V_{CC}=1.65\text{V to }1.95\text{V}$	$0.65 \times V_{CC}$		V
		$V_{CC}=2.3\text{V to }2.7\text{V}$	1.7		
		$V_{CC}=3\text{V to }3.6\text{V}$	2.2		
		$V_{CC}=4.5\text{V to }5.5\text{V}$	$0.7 \times V_{CC}$		
Low-level input voltage	$V_{IL}$	$V_{CC}=1.65\text{V to }1.95\text{V}$		$0.15 \times V_{CC}$	V
		$V_{CC}=2.3\text{V to }2.7\text{V}$		0.3	
		$V_{CC}=3\text{V to }3.6\text{V}$		0.4	
		$V_{CC}=4.5\text{V to }5.5\text{V}$		$0.15 \times V_{CC}$	
Input voltage	$V_I$		0	5.5	V
Output voltage	$V_O$		0	$V_{CC}$	V
Input transition rise or fall	$t_r, t_f$	$V_{CC}=1.8\text{V} \pm 0.15\text{V}, 2.5\text{V} \pm 0.2\text{V}$		20	ns/V
		$V_{CC}=3.3\text{V} \pm 0.3\text{V}$		10	
		$V_{CC}=5\text{V} \pm 0.5\text{V}$		5	
Operating temperature	$T_A$		-40	+125	$^{\circ}\text{C}$

(1) All unused inputs of the device must be held at  $V_{CC}$  or GND to ensure proper device operation.

**DC Characteristics**

PARAMETER		TEST CONDITIONS	V <sub>CC</sub>	TEMP	MIN	TYP	MAX	UNIT
V <sub>OH</sub>	I <sub>OH</sub> = -100μA		1.65V to 5.5V	Full	V <sub>CC</sub> -0.1			V
	I <sub>OH</sub> = -4mA		1.65V		1.2			
	I <sub>OH</sub> = -8mA		2.3V		1.9			
	I <sub>OH</sub> = -16mA		3V		2.4			
	I <sub>OH</sub> = -24mA				2.3			
	I <sub>OH</sub> = -32mA		4.5V		3.8			
V <sub>OL</sub>	I <sub>OL</sub> = 100μA		1.65V to 5.5V	Full			0.1	V
	I <sub>OL</sub> = 4mA		1.65V				0.45	
	I <sub>OL</sub> = 8mA		2.3V				0.3	
	I <sub>OL</sub> = 16mA		3V				0.4	
	I <sub>OL</sub> = 24mA						0.55	
	I <sub>OL</sub> = 32mA		4.5V				0.55	
I <sub>i</sub>	A or B inputs	V <sub>I</sub> =5.5V or GND	0V to 5.5V	+25°C		±0.1	±1	μA
				Full			±5	
I <sub>off</sub>	V <sub>I</sub> or V <sub>O</sub> =5.5V		0	+25°C		±0.1	±1	μA
				Full			±10	
I <sub>CC</sub>	V <sub>I</sub> =5.5V or GND, I <sub>O</sub> =0		1.65V to 5.5V	+25°C		0.1	1	μA
				Full			10	
ΔI <sub>CC</sub>	One input at V <sub>CC</sub> -0.6V, Other inputs at V <sub>CC</sub> or GND		3V to 5.5V	Full			500	μA

**AC Characteristics**

PARAMETER	SYMBOL	TEST CONDITIONS		TEMP	MIN	TYP	MAX	UNIT
Propagation Delay	t <sub>pd</sub>	V <sub>CC</sub> =1.8V±0.15V	C <sub>L</sub> =30pF, R <sub>L</sub> =500Ω	Full		21		ns
		V <sub>CC</sub> =2.5V±0.2V	C <sub>L</sub> =30pF, R <sub>L</sub> =500Ω	Full		7.8		
		V <sub>CC</sub> =3.3V±0.3V	C <sub>L</sub> =50pF, R <sub>L</sub> =500Ω	Full		5.7		
		V <sub>CC</sub> =5V±0.5V	C <sub>L</sub> =50pF, R <sub>L</sub> =500Ω	Full		4.2		
Input Capacitance	C <sub>i</sub>	V <sub>CC</sub> =3.3V	V <sub>I</sub> =V <sub>CC</sub> or GND	+25°C		4		pF
Power dissipation capacitance	C <sub>pd</sub>	V <sub>CC</sub> =1.8V	f=10MHz	+25°C		21		pF
		V <sub>CC</sub> =2.5V				22		
		V <sub>CC</sub> =3.3V				22		
		V <sub>CC</sub> =5V				25		

## Parameter Measurement Information

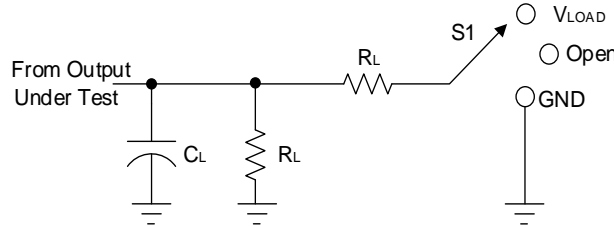

TEST	S1
$t_{PLH}/t_{PHL}$	Open
$t_{PLZ}/t_{PZL}$	$V_{LOAD}$
$t_{PHZ}/t_{PZH}$	GND

$V_{CC}$	INPUTS		$V_M$	$V_{LOAD}$	C <sub>L</sub>		R <sub>L</sub>		$V_{\Delta}$
	$V_I$	$t_r/t_f$							
1.8V±0.15V	$V_{CC}$	≤2ns	$V_{CC}/2$	2 x $V_{CC}$	15pF	30pF	1MΩ	1kΩ	0.15V
2.5V±0.2V	$V_{CC}$	≤2ns	$V_{CC}/2$	2 x $V_{CC}$	15pF	30pF	1MΩ	500Ω	0.15V
3.3V±0.3V	3V	≤2.5ns	1.5V	6V	15pF	50pF	1MΩ	500Ω	0.3V
5V±0.5V	$V_{CC}$	≤2.5ns	$V_{CC}/2$	2 x $V_{CC}$	15pF	50pF	1MΩ	500Ω	0.3V

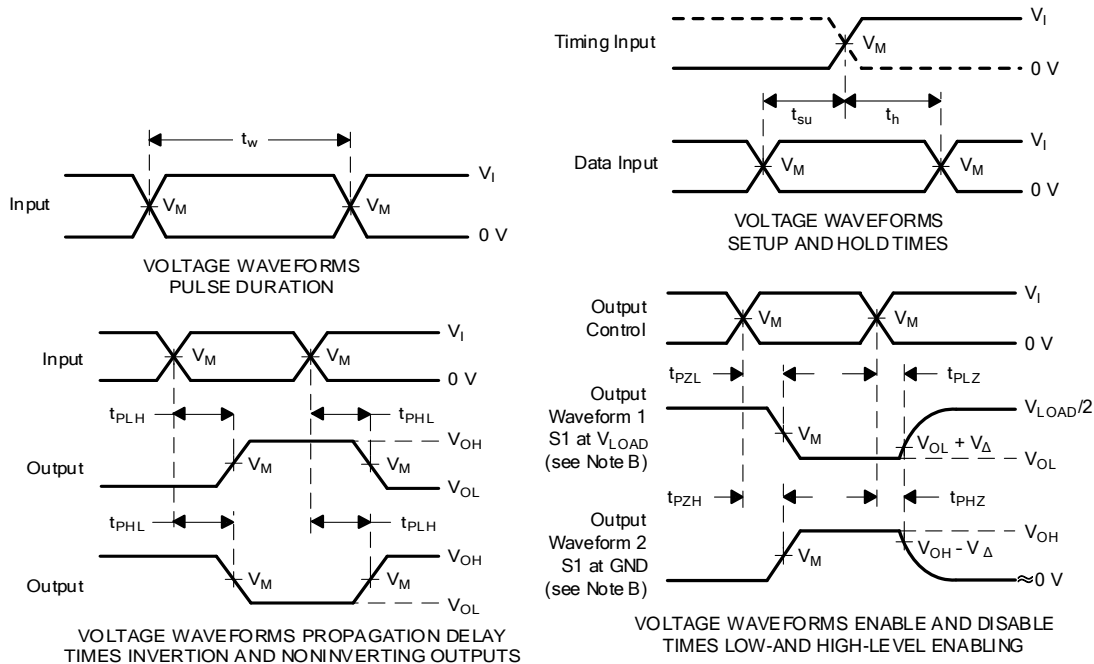

- NOTES: A.  $C_L$  includes probe and jig capacitance.  
 B. Waveform 1 is for an output with internal conditions such that the output is low, except when disabled by the output control. Waveform 2 is for an output with internal conditions such that the output is high, except when disabled by the output control.  
 C. All input pulses are supplied by generators having the following characteristics:  $PRR \leq 10$  MHz,  $Z_o = 50 \Omega$ .  
 D. The outputs are measured one at a time, with one transition per measurement.  
 E.  $t_{PLZ}$  and  $t_{PHZ}$  are the same as  $t_{dis}$ .  
 F.  $t_{PZL}$  and  $t_{PZH}$  are the same as  $t_{en}$ .  
 G.  $t_{PLH}$  and  $t_{PHL}$  are the same as  $t_{pd}$ .  
 H. All parameters and waveforms are not applicable to all devices.

**Figure 1. Load Circuit and Voltage Waveforms**



# PACKAGE OUTLINE DIMENSIONS

## SOT23-5

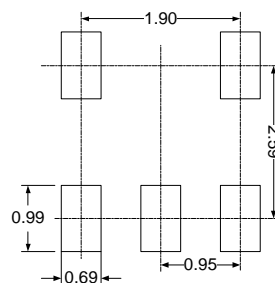
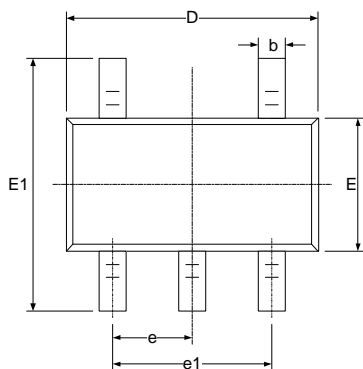
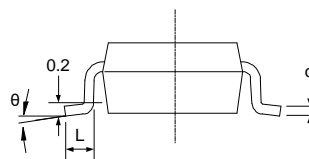
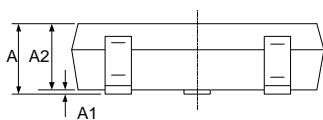
**RECOMMENDED LAND PATTERN (Unit: mm)**

Symbol	Dimensions In Millimeters		Dimensions In Inches	
	Min	Max	Min	Max
A	1.050	1.250	0.041	0.049
A1	0.000	0.100	0.000	0.004
A2	1.050	1.150	0.041	0.045
b	0.300	0.500	0.012	0.020
c	0.100	0.200	0.004	0.008
D	2.820	3.020	0.111	0.119
E	1.500	1.700	0.059	0.067
E1	2.650	2.950	0.104	0.116
e	0.950(BSC)		0.037(BSC)	
e1	1.800	2.000	0.071	0.079
L	0.300	0.600	0.012	0.024
$\theta$	0°	8°	0°	8°

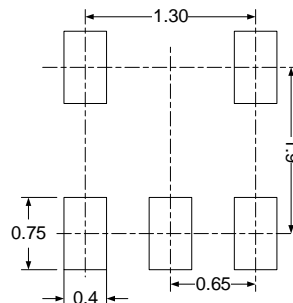
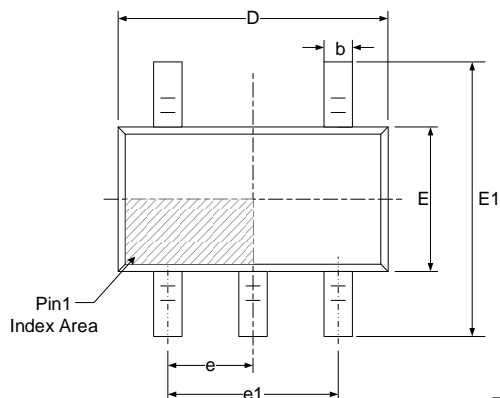
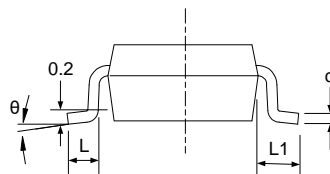
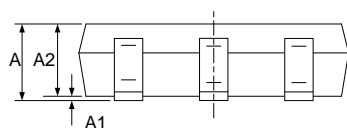
**SOT353 (SC70-5)**

**RECOMMENDED LAND PATTERN (Unit: mm)**

Symbol	Dimensions In Millimeters		Dimensions In Inches	
	Min	Max	Min	Max
A	0.900	1.100	0.035	0.043
A1	0.000	0.100	0.000	0.004
A2	0.900	1.000	0.035	0.039
b	0.150	0.350	0.006	0.014
c	0.080	0.150	0.003	0.006
D	2.000	2.200	0.079	0.087
E	1.150	1.350	0.045	0.053
E1	2.150	2.450	0.085	0.096
e	0.650(BSC)		0.026(BSC)	
e1	1.300(BSC)		0.051(BSC)	
L	0.260	0.460	0.010	0.018
L1	0.525		0.021	
θ	0°	8°	0°	8°

## TAPE AND REEL INFORMATION

### REEL DIMENSIONS

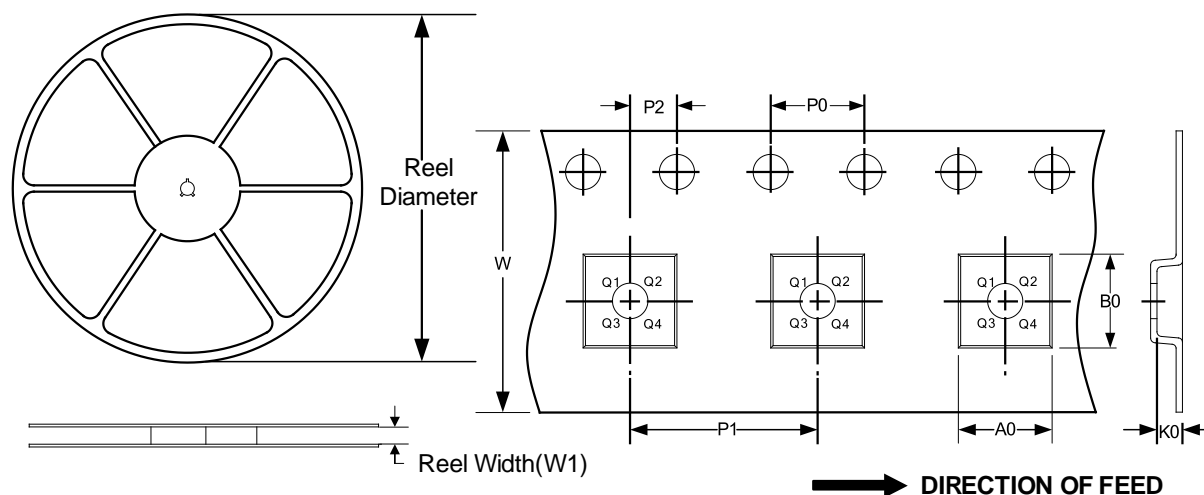
### TAPE DIMENSION



NOTE: The picture is only for reference. Please make the object as the standard.

### KEY PARAMETER LIST OF TAPE AND REEL

Package Type	Reel Diameter	Reel Width(mm)	A0 (mm)	B0 (mm)	K0 (mm)	P0 (mm)	P1 (mm)	P2 (mm)	W (mm)	Pin1 Quadrant
SOT353(SC70-5)	7"	9.5	2.25	2.55	1.20	4.0	4.0	2.0	8.0	Q3
SOT23-5	7"	9.5	3.20	3.20	1.40	4.0	4.0	2.0	8.0	Q3