



# SS32F THRU SS320F Surface Mount Schottky Rectifiers

Reverse Voltage - 20 to 200 V  
Forward Current - 3.0A

## Features

- Metal silicon junction, majority carrier conduction
- For surface mounted applications
- Low power loss, high efficiency
- High forward surge current capability
- For use in low voltage, high frequency inverters, free wheeling, and polarity protection applications

## PINNING

PIN	DESCRIPTION
1	Cathode
2	Anode

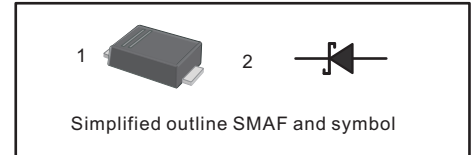

## MECHANICAL DATA

- Case: SMAF
- Terminals: Solderable per MIL-STD-750, Method 2026
- Approx. Weight: 27mg 0.00095oz

## Absolute Maximum Ratings and Electrical characteristics

Ratings at 25 °C ambient temperature unless otherwise specified. Single phase, half wave, 60Hz resistive or inductive load, for capacitive load, derate by 20 %

Parameter	Symbols	SS32F	SS34F	SS34AF	SS36F	SS38F	SS310F	SS312F	SS315F	SS320F	Units
Maximum Repetitive Peak Reverse Voltage	$V_{RRM}$	20	40	45	60	80	100	120	150	200	V
Maximum RMS voltage	$V_{RMS}$	14	28	31.5	42	56	70	84	105	140	V
Maximum DC Blocking Voltage	$V_{DC}$	20	40	45	60	80	100	120	150	200	V
Maximum Average Forward Rectified Current	$I_{F(AV)}$	3.0									A
Peak Forward Surge Current, 8.3ms Single Half Sine-wave Superimposed on Rated Load (JEDEC method)	$I_{FSM}$	80					70				A
Max Instantaneous Forward Voltage at 2 A	$V_F$	0.55		0.70			0.85		0.95		V
Maximum DC Reverse Current at Rated DC Reverse Voltage $T_a = 25^\circ\text{C}$ $T_a = 100^\circ\text{C}$ $T_a = 125^\circ\text{C}$	$I_R$	0.5 5 /			0.3 / 5					mA	
Typical Thermal Resistance <sup>1)</sup>	$R_{\theta JA}$	55									°C/W
Operating Junction Temperature Range	$T_j$	-55 ~ +125									°C
Storage Temperature Range	$T_{stg}$	-55 ~ +150									°C

1) P.C.B. mounted with 0.5 X 0.5" (12.7 X 12.7 mm) copper pad areas.



# SS32F THRU SS320F Surface Mount Schottky Rectifiers

**Characteristic Curves** (T = 25 °C unless otherwise noted)

**Fig.1 Forward Current Derating Curve**

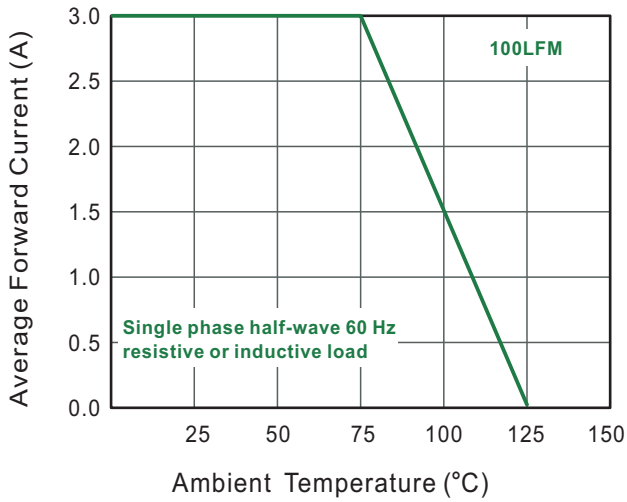

**Fig.2 Typical Reverse Characteristics**

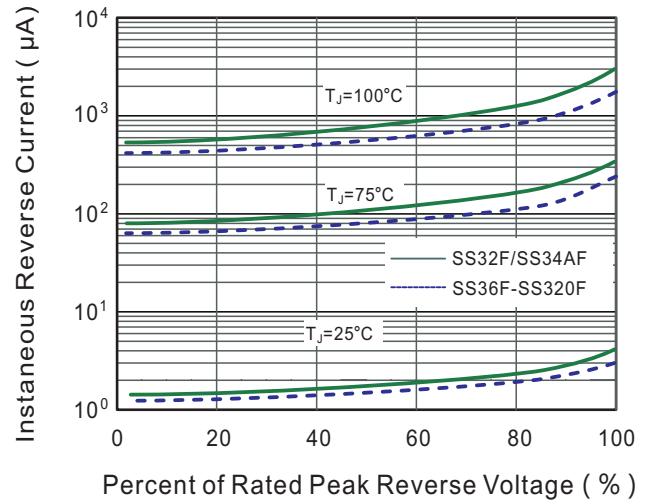

**Fig.3 Typical Forward Characteristic**

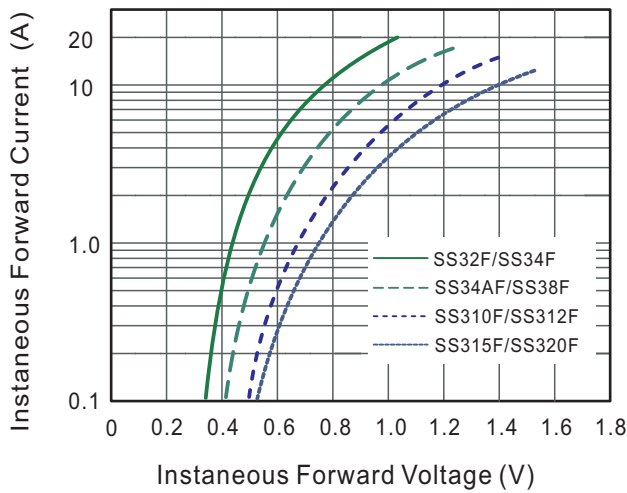

**Fig.5 Maximum Non-Repetitive Peak Forward Surge Current**

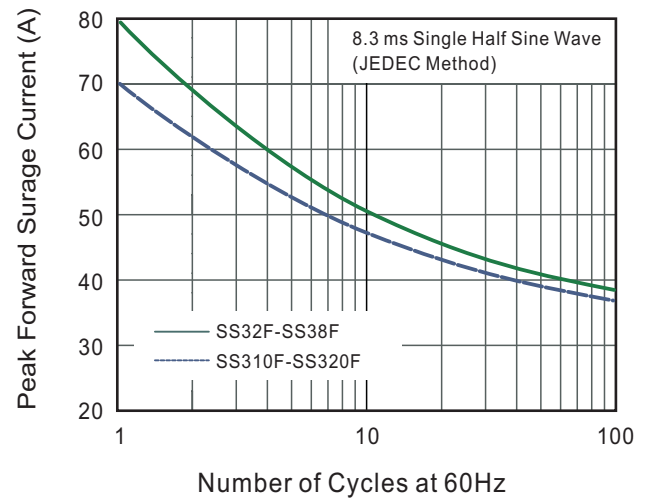



# SS32F THRU SS320F Surface Mount Schottky Rectifiers

## PACKAGE OUTLINE

Plastic surface mounted package; 2 leads

SMAF

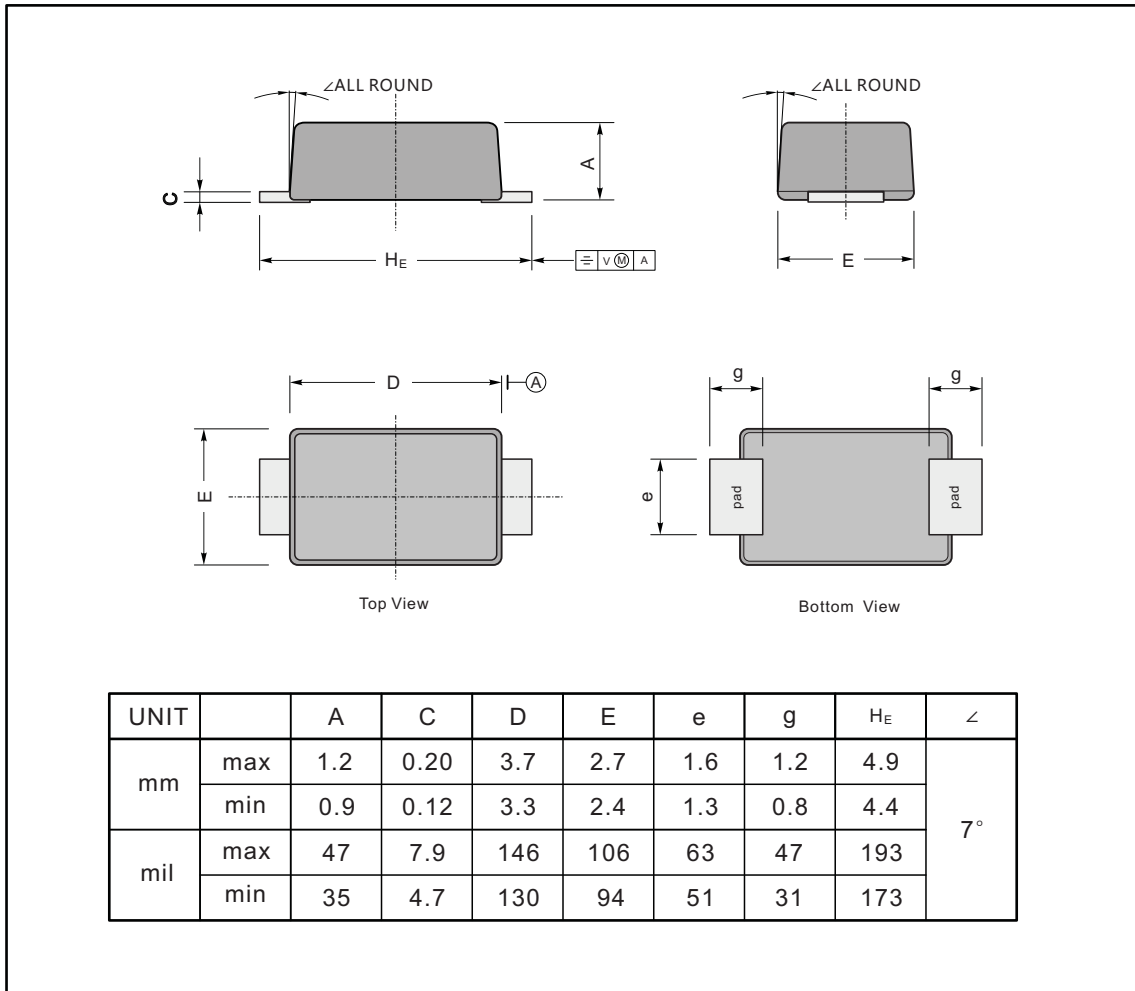

### The recommended mounting pad size

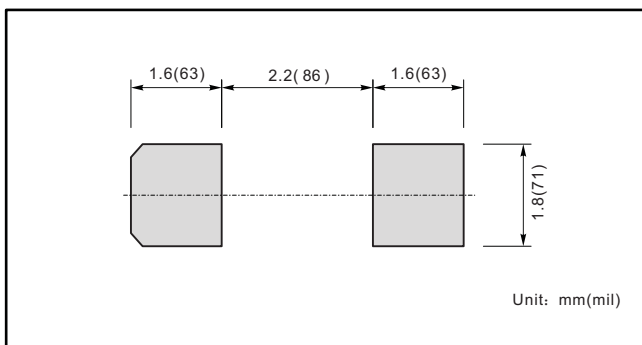

### Marking

Type number	Marking code
SS32F	SS32
SS34F	SS34
SS36F	SS36
SS38F	SS38
SS310F	SS310
SS312F	SS312
SS315F	SS315
SS320F	SS320