

PWM Control Circuit

(compatible to TL494)

Description

The HT494A incorporates on a single monolithic chip all the function required in the development of a pulse - width modulation control circuits. Designed primarily for power supply control , the HT494A contains an on-chip 5 volt regulator, two error amplifiers, adjustable oscillator, dead time control comparator, pulse-steering flip-flop, and output control circuitry. The uncommitted output transistors provide either common-emitter or emitter-follower output capability. Push-pull or single-ended output operation may be selected through the output-control function. The architecture of the HT494A prohibits the possibility of either output being pulsed twice during push-pull operation.

Features

- Complete PWM Power Control Circuitry
- Uncommitted Outputs for 200 mA Sink or Source
- Output Control Selects Single-Ended or Push-Pull Operation
- Internal Circuitry Prohibits Double Pulse at Either Output
- Internal Regulator Provides a Stable 5V Reference Supply
- Variable Dead-Time Provides Control Over Whole Range

Function Table

Output Control	Output Function
Grounded	Single-ended or Parallel Output
At V_{ref}	Normal Push-Pull Operation

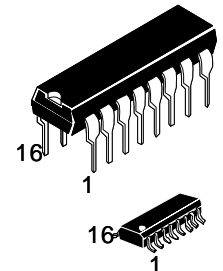

ORDERING INFORMATION

HT494ANZ DIP
 HT494ARZ SOP
 HT494ARTZ TSSOP

$T_A = -40^\circ$ to 85°C for all packages.

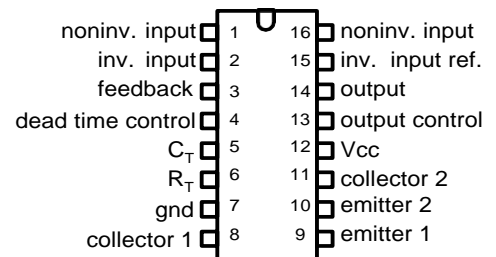

Block Diagram

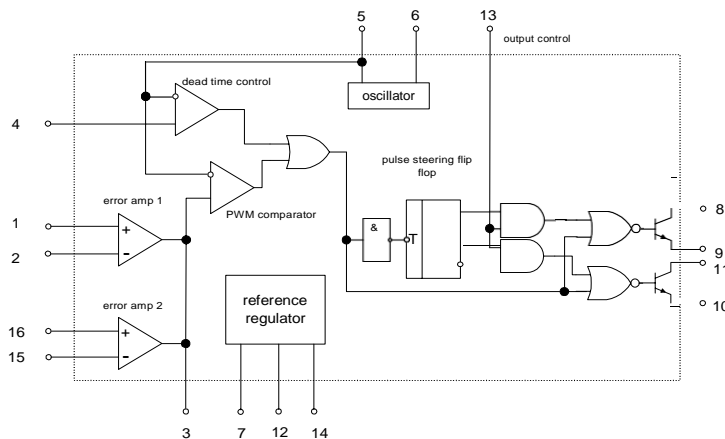

Standard deviation is derived from the formula

$$\sigma = \sqrt{\frac{\sum_{n=1}^N (X_n - \bar{X})^2}{N - 1}}$$

RECOMMENDED OPERATION CONDITIONS

PARAMETER	MIN	MAX	UNIT
Supply Voltage	7	40	V
Amplifier Input Voltage	-0.3	V _{CC} -2	V
Collector Output Voltage		40	V
Collector Output Current (Each Transistor)		200	mA
Current Into Feedback Terminal		0.3	mA
Timing Capacitor	0.47	10000	nF
Timing Resistor	1.8	500	kΩ
Oscillator Frequency	1	300	kHz
Operating Free-Air Temperature	-20	85	°C

ABSOLUTE MAXIMUM RATINGS

Supply Voltage	41V
Amplifier Input Voltage	V _{CC} +0.3V
Collector Output Voltage	41V
Continuous Total Dissipation at (or below) 25°C	1000mW
Operating Free-Air Temperature Range	-20 to 85°C
Storage Temperature Range	-65 to 150°C
Collector Output Current	250mA

Electrical Characteristics (Temperature -20...85°C, V_{CC}=15V, f=10kHz)
REFERENCE SECTION

PARAMETER	TEST CONDITIONS	MIN	MAX	UNIT
Output voltage (V _{ref})	I _o =1mA	4.75	5.25	V
Input regulation	V _{CC} =7V to 40V, T _a =25°C		25	mV
Output regulation	I _o =1 to 10mA, T _a =25°C		15	mV
Output voltage change with temperature	T _a =-20 °C to 85 °C		1	%
Short circuit output current	V _{ref}		60	mV

DEAD TIME CONTROL SECTION

PARAMETER	TEST CONDITIONS	MIN	MAX	UNIT
Input bias current (pin 4)	V _i =0V to 5.25V		-10	μA
Maximum duty cycle (each output)	V _{i(pin 4)} =0V	45		%
Input threshold voltage (pin 4)	zero duty cycle		3.3	V
	maximum duty cycle	0		V

ERROR AMPLIFIERS SECTION

PARAMETER	TEST CONDITIONS		MIN	MAX	UNIT
Input offset voltage	V _{o(pin 3)} =2.5			10	mV
Input offset current	V _{o(pin 3)} =2.5			250	nA
Input bias current	V _{o(pin 3)} =2.5			1	μA
Common mode input voltage range	V _{CC} =7 to 40V	LOW	-0.3		V
		HIGH	V _{CC} -2		V
Open loop voltage amplification	ΔV _o =3V, V _o =0.5 to 3.5V		70		dB
Unity-gain bandwidth			100		kHz
Common mode rejection ratio	V _{CC} =40V, T _a =25°C		65		dB
Output sink current (pin 3)	V _{ID} =-15mV to -5V, V _{o(pin 3)} =0.7V		0.3		mA
Output source current (pin 3)	V _{ID} =15mV to 5V, V _{o(pin 3)} =3.5V		-2		mA

DISSIPATION RATING TABLE

PACKAGE	T _A = 25°C POWER RATING	OPERATING FACTOR	DERATE ABOVE T _A	T _A =70°C POWER RATING	T _A =85°C POWER RATING
D	900 mW	7.6 mW/°C	25°C	608 mw	494 mW
N	1000 mW	9.2 mW/°C	41°C	736 mW	598 mW

PWM COMPARATOR SECTION

PARAMETER	TEST CONDITIONS	MIN	MAX	UNIT
Input threshold voltage (pin 3)	zero duty cycle		4.5	V
Input sink current (pin 3)	$V_{o(\text{pin } 3)}=0.7V$	0.3		mA

SWITCHING CHARACTERISTICS

PARAMETER	TEST CONDITIONS	MIN	MAX	UNIT
Output voltage rise time	Common emitter		200	ns
Output voltage fall time	configuration		100	ns
Output voltage rise time	Emitter-follower		200	ns
Output voltage fall time	configuration		100	ns

OUTPUT SECTION

PARAMETER	TEST CONDITIONS	MIN	MAX	UNIT
Collector off-state current	$V_{CE}=40V, V_{CC}=40V$		100	μA
Emitter off-state current	$V_{CC}=V_C=40V, V_E=40V$		-100	μA
Collector - Emitter	Common emitter	$V_E=0, I_C=200mA$	1.3	V
saturation voltage	Emitter-follower	$V_C=15V, I_E=-200mA$	2.5	V
Output control input current	$V_i=V_{ref}$		3.5	mA

OSCILLATOR SECTION

PARAMETER	TEST CONDITIONS	MIN	MAX	UNIT
Frequency	$C_T=0.01\mu F, R_T=12k\Omega$		30	kHz
Standard deviation of frequency	All Values of V_{CC}, C_T, R_T, T_a are constant		30	%
Frequency change with voltage	$V_{CC}=7V$ to $40V, T_a=25^\circ C$		10	%
Frequency change with temperature	$C_T=0.01\mu F, R_T=12k\Omega,$		2	

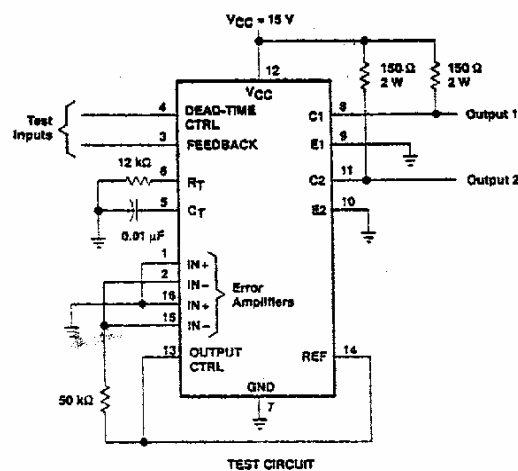
PARAMETER MEASUREMENT INFORMATION

TEST CIRCUIT

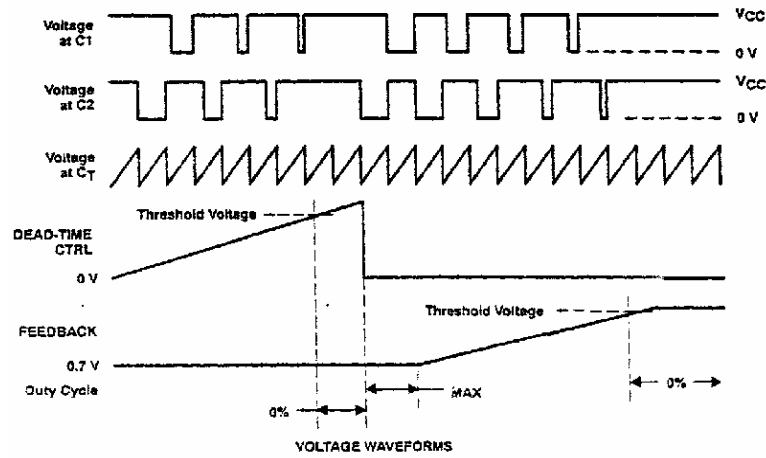

Figure 1. Operational Test Circuit and Waveforms

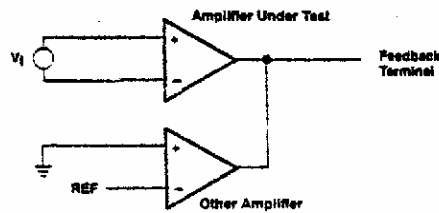

Figure 2. Amplifier Characteristics

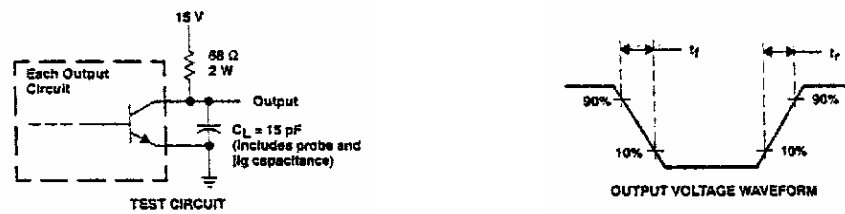

Figure 3. Common-Emitter Configuration

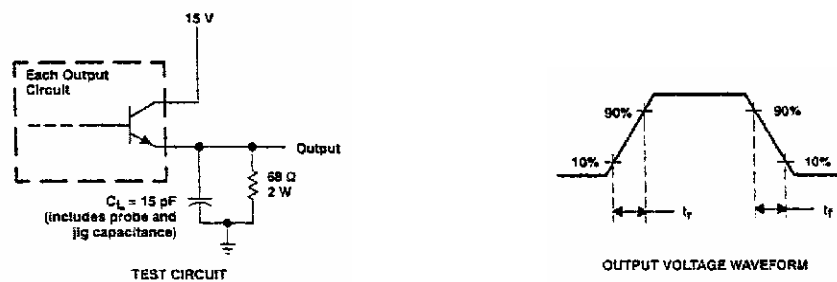

Figure 4. Emitter-Follower Configuration

TYPICAL CHARACTERISTICS
OSCILLATOR FREQUENCY AND FREQUENCY VARIATION
VS
TIMING RESISTANCE

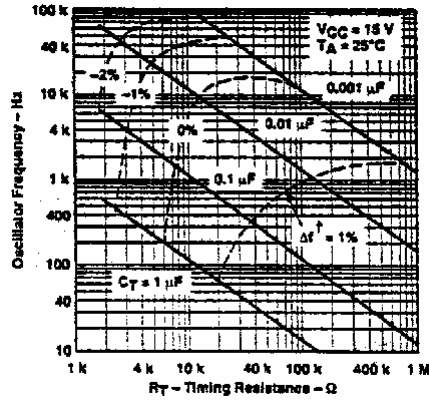

Figure 5

AMPLIFIER VOLTAGE AMPLIFICATION vs FREQUENCY

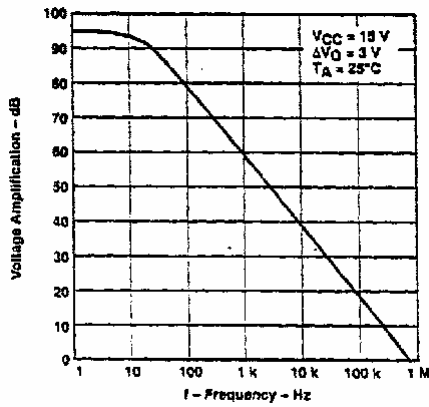
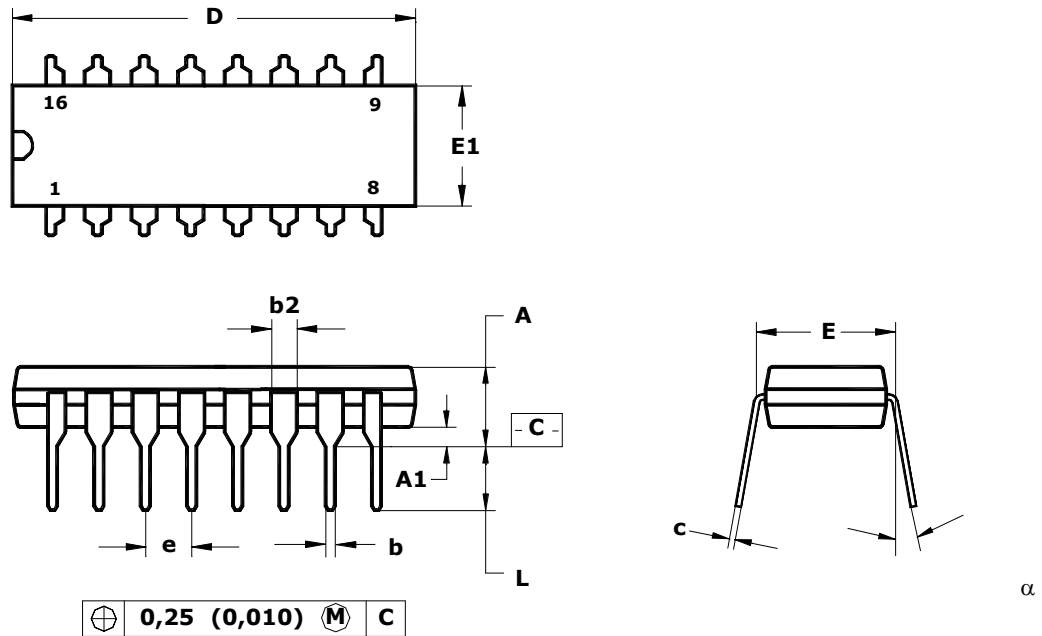
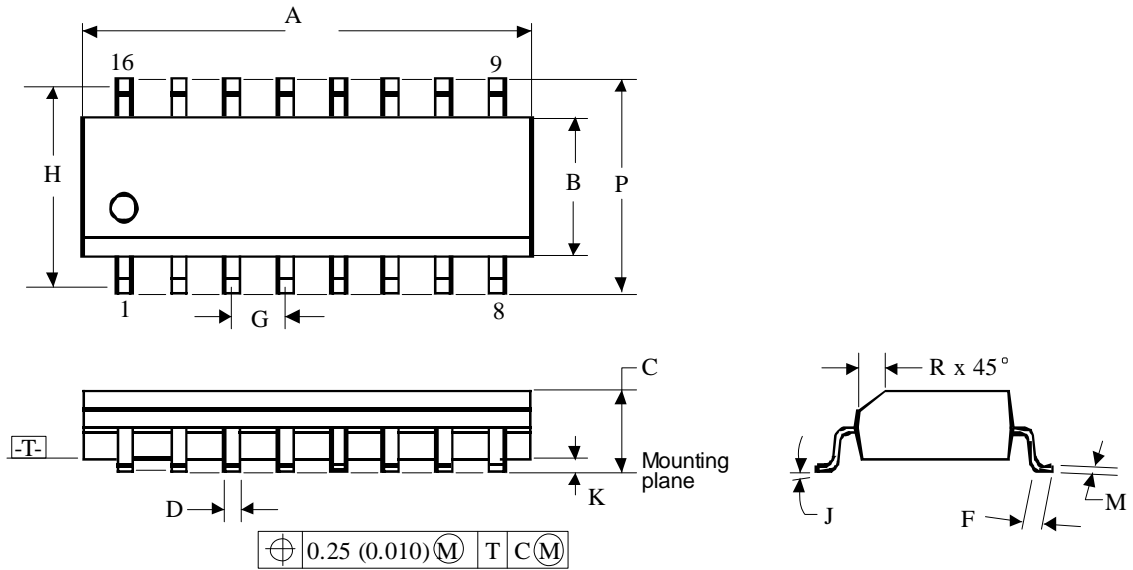

Figure 6

Package Dimensions
DIP16

Note - Dimensions D, E1 do not include the fin value, which should not exceed 0.25 mm (0.010) per side.

	D	E1	A	b	b2	e	α	L	E	c	A1
mm											
min	18.93	6.07	—	0.36	1.14	2.54	0°	2.93	7.62	0.20	0.38
max	19.43	7.11	5.33	0.56	1.78		15°	3.81	8.26	0.36	—
Inches											
min	0.355	0.240	—	0.014	0.045	0.1	0°	0.115	0.300	0.008	0.015
max	0.400	0.280	0.210	0.022	0.070		15°	0.150	0.325	0.014	—

Package Dimensions
SOP16

Note:

1. Dimensional sizes A and B are preset without consideration of fin and the metal bulges.
2. Availability of the fin and the metal bulges for A – up to 0.15 mm (0.006) per side; for B – up to 0.25 mm (0.010) per side.

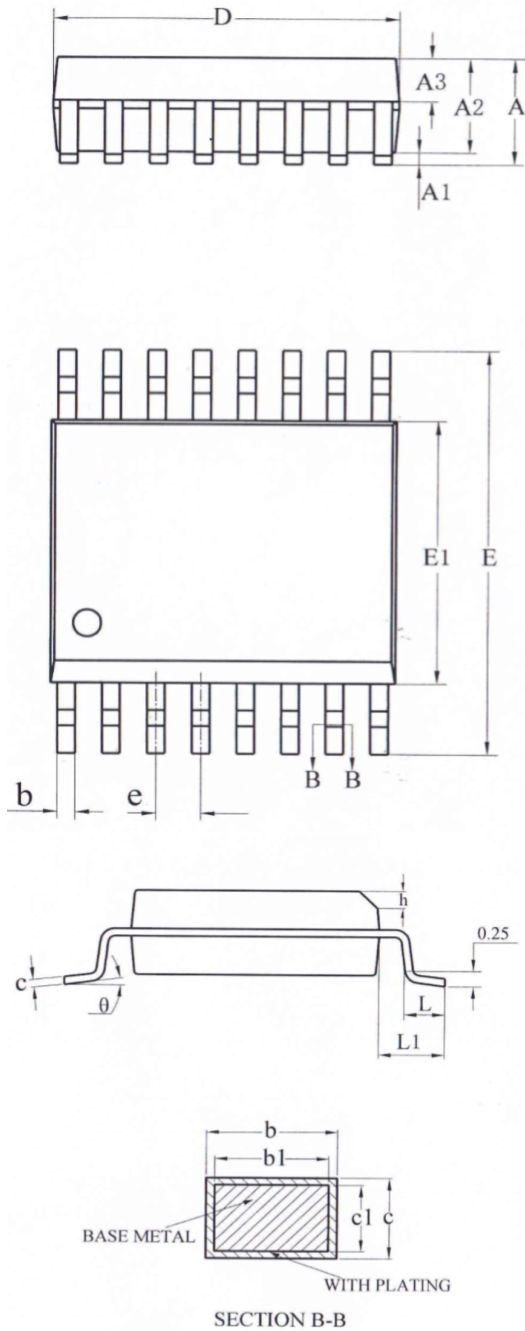
Identifi- cation	Sizes, mm	
	MIN	MAX
A	9.80	10.0
B	3.80	4.00
C	1.35	1.75
D	0.33	0.51
F	0.40	1.27
G	1.27	
H	5.72	
J	0°	8°
K	0.10	0.25
M	0.19	0.25
P	5.80	6.20
R	0.25	0.50

Package Dimensions
TSSOP16

SYMBOL	MILLIMETER		
	MIN	NOM	MAX
A	—	—	1.75
A1	0.10	—	0.225
A2	1.30	1.40	1.50
A3	0.55	0.60	0.65
b	0.23	—	0.31
b1	0.22	0.25	0.28
c	0.20	—	0.24
c1	0.19	0.20	0.21
D	4.80	4.90	5.00
E	5.80	6.00	6.20
E1	3.80	3.90	4.00
e	0.635BSC		
h	0.25	—	0.50
L	0.50	0.65	0.80
L1	1.05REF		
θ	0	—	8°